



Colonisation of Model Oral Biofilms  
by *Streptococcus mutans*

**Suhair Wadea Abbood Al-Osaighari**

**A thesis submitted for the degree of Doctor of Philosophy**

**School of Dental Sciences**

**Institute for Cell and Molecular Biosciences (ICAMB)**

**August 2017**



## **Abstract**

Dental plaque is a mixed-species microbial biofilm that forms on tooth surfaces. Incorporation of acidogenic bacteria such as *Streptococcus mutans* within the biofilm results in development of carious lesions. This research project aims to establish a reproducible model of early colonising oral bacteria and use it to assess *S. mutans* integration into biofilms.

The Modified Robbins Device (MRD) was used to develop mixed species biofilms from *Streptococcus gordonii* DL1, *Actinomyces oris* MG1, and *Veillonella parvula* PK1910, with or without 0.1% sucrose. These biofilms were challenged with *S. mutans* UA159 or GS5. Quantitative PCR and a variety of microscopic imaging approaches were used to assess the structure and stability of early coloniser biofilms and to study *S. mutans* incorporation.

Reproducible and stable early coloniser biofilms were established. The presence of sucrose had no effect on biofilm formation. Challenging preformed biofilms with *S. mutans* had no effect on the early coloniser species, but resulted in differences in the appearance of biofilm matrix. Significant differences were observed between *S. mutans* strains: after 24 h *S. mutans* UA159 was about 20-fold more abundant in the biofilm than *S. mutans* GS5.

The impact of extracellular DNA on *S. mutans* GS5 colonisation was studied by replacing the wild-type *S. gordonii* with a mutant disrupted in the *ssnA* gene encoding an extracellular deoxyribonuclease. There was no significant difference in *S. mutans* between preformed biofilms with wild-type and mutant *S. gordonii*, indicating that SsnA does not play a role in determining *S. mutans* colonisation in this system.

A reproducible system for culturing early coloniser oral biofilms has been established here that will be useful for further investigations of biofilm colonisation by oral bacteria. Differences in the ability of different *S. mutans* strains to colonise may be further explored through targeted mutagenesis to find key factors responsible for colonisation.



## **Acknowledgment**

In the name of Allah, my thanks and gratefulness for his blessings and support, which has given me the strength and courage to get what he decided to give me. My great lord I faced lots of hard days, walking a difficult road away from my home country, but you were always there in my mind and heart, to guide me, fix my steps to go on, and keep me progressing.

I believe that Allah's blessings come in the form of good people who he puts in the way of a person, and this is what I get, real Allah blessings. To all the people whose names are mentioned below, not only the word thanks, but all the words that carry or express the meaning of thankfulnes, appreciation, and respect are not enough to reflect the correct expression of my gratefulness for their kindness, love, and support.

Starting with my supervisors, Dr. Jakubovics and Dr. Waterhouse, after Allah without your support and encouragement from the first step in my PhD journey, and without all of your advice and continuous follow up on my progress, there would have been no PhD thesis by Suhair Wadea Abbood. I will always remember how you kindly kept reassuring me, kept me calm, and how much you were patient in handling my continuous worries; your personalities are unforgettable. I will be very proud to see you as higher examples in my coming academic life, if Allah wills it.

To all my friends, my great thanks and sorry for saying just this: all of you deserve more and more words of thanks my dears, and my appreciation for your kind help, support, and encouragement. Be sure that I will always ask Allah to bless your days, and keep you progressing and successful. To my dear Saba, Sufian, Jill, Rachel, Katrin, Becky (the lab angel), Nadia (the lab spirit of fun), Anas, Ali Wayes, and Ahmed Salih, my respect to all of you.

To dear Mustafa, Ahmed Ghanim, , Nieka, Christopher, Simone, Martin, Andrea, Haaris, Catherine, Subash, and Nehir, thanks for being such wonderful colleagues. Dear Jane, thanks for being such a lovely, friendly person; your kind concern about how I am doing really means a lot to me, Allah bless you my dear. To my dear Ekaterina, although it was a very short time knowing each other, I am sure that you are a kind and supportive person, and thanks for your friendly feelings.

To my dear Lesley, all my respect and appreciation for all your efforts; you were always there not only for me, but for everybody in the oral microbiology lab. For me, you are more than a lab manager, you are that person who makes me feel safe and secure, the same feeling that I have when I am at home with my mother; this is what you mean to me my dear Lesley, Allah bless you and thanks a lot.

My dear Pam, thanks a lot for your help, you have always kindly provided me with what I need for certain experiments as quickly as you can, bless you my dear, and all my best wishes and respect. My dear Joy, I really appreciate all your kind management for everything, your continuous encouragement, your concern about me, the feeling that only comes from a real loving sister, it means a lot to me, thank you my dear, Allah bless you and keep you always in health and happiness.

To the IT supportive angel, my dear Mark, I really appreciate your continuous support, and kind help whenever there was an IT problem. Thanks for always being a smiling person with such a wonderful friendly spirit, Allah bless you my dear.

My thanks and appreciation to the SEM lab team, dear Tracey, Kathryn, and Ross. Thanks for presenting such great help and support while examining and imaging my samples. Thanks for being such a friendly and cooperative team, and all my respect.

My great thanks and appreciation to the CLSM lab team, Dr. Trevor, Dr. Alex, and the other team members. Dr. Trevor, I really appreciate your kind efforts to teach me and your patience with me in handling my samples, all my respect for your supportive cooperation, friendly spirit, and continuous welcome during the long period of my sample examination.

My appreciation to the people in the dental material lab, Dr. Matt, Dr. Jacob, and Mr. Andrew, thanks for your kind cooperation and permitting the use of the lab facilities to prepare my samples, my appreciation for your help and friendly hospitality.

All my appreciation and respect to Ms. Sharon Pointer for her kind efforts and managing the thesis proofreading, although the time was so critical, but she did her best to make me do it in the time, Allah bless you my dear and thanks a lot for your cooperation and understanding.

Being a PhD student in Newcastle University was such a great honour and remarkable opportunity in my life, and thanks for the welcome and all the supportive facilities, whether scientific or social; all my respect and appreciation.

To my home country, Iraq, with so many wounds and sacrifices, you still support your own children, and Allah bless that great piece of earth, bless your sky, and bless your kind patient citizens. Thanks for all the supportive effort that I have received as an Iraqi PhD student, whether from inside or outside of Iraq, from the Iraqi Ministry of Higher Education and Scientific Research, The Department of Scholarships and Cultural Relationships, the Iraqi Cultural Attaché in the United Kingdom, Al-Anbar University, and the College of Dentistry in Al-Anbar University, Allah bless all your honest efforts to raise the level of higher education in Iraq to a proper academic and scientific rank worthy of the great name of Iraq.

To my dearest brothers, Sameer and Nameer, and their lovely families, thanks a lot for all your support and encouragement, Allah bless you, wish you all the best from the deepest part of my heart. By Allah's mercy, our Mum and Dad, both represent to me the hand that keeps holding me and encouraging my steps to move forward.

All my love, appreciation, and great thanks to you my dear Mother, my precious jewel. Allah blesses that walking on earth, after Allah your prayers are always with me, and this thesis is for you. I hope you accept it from me just as humble payback for your continuous and unbelievable support without complaint. My dear Father (Allah bless your soul), although you passed away eleven years ago, you are always with me, and I feel you in my heart and mind; I keep walking on what you taught me and raised me up on, and this thesis carries your name before my name. I am sure you would be proud of me if you were still here, but believe it or not, yes you are still here as long as I live there are two spirits in one body, love you my dear Dad and miss you a lot.





## Table of Contents

Abstract .....	i
Acknowledgment .....	iii
List of Figures .....	xii
List of Tables.....	xv
List of Abbreviations.....	xvi
<b>Chapter 1. Introduction.....</b>	<b>1</b>
<b>1.1 Dental Caries.....</b>	<b>2</b>
<i>1.1.1 Aetiology of dental caries .....</i>	<i>3</i>
<i>1.1.2 Mechanism of dental caries development.....</i>	<i>4</i>
<i>1.1.3 Dental caries in children .....</i>	<i>7</i>
<i>1.1.4 Prevention of dental caries.....</i>	<i>9</i>
<b>1.2 Dental Plaque Biofilm .....</b>	<b>11</b>
<i>1.2.1 Mechanism of dental plaque development .....</i>	<i>12</i>
<i>1.2.2 Structure of dental plaque.....</i>	<i>13</i>
<i>1.2.3 Dental plaque and dental caries disease .....</i>	<i>15</i>
<i>1.2.4 Methods of dental biofilm control.....</i>	<i>16</i>
<b>1.3 Oral Microflora.....</b>	<b>17</b>
<i>1.3.1 Microbial population of oral microflora.....</i>	<i>19</i>
<i>1.3.2 Bacterial interactions in oral biofilms .....</i>	<i>20</i>
<i>1.3.3 Early coloniser bacterial species in dental biofilm.....</i>	<i>21</i>
<i>1.3.4 Cariogenic bacterial species in dental biofilm.....</i>	<i>22</i>
<i>1.3.5 Streptococcus mutans in dental biofilm.....</i>	<i>24</i>
<i>1.3.6 The role of exopolysaccharides (EPS) in later coloniser biofilm .....</i>	<i>24</i>
<i>1.3.7 The role of extracellular DNA (eDNA) in biofilms.....</i>	<i>26</i>
<b>1.4 Models for Cariogenic Biofilms <i>In vivo</i> and <i>In vitro</i> .....</b>	<b>29</b>
<i>1.4.1 Cariogenic biofilms models in vivo .....</i>	<i>29</i>
<i>1.4.2 Cariogenic biofilms models in vitro .....</i>	<i>31</i>

1.5 Aims and Objectives .....	36
<b>Chapter 2. Materials and Methods .....</b>	<b>37</b>
2.1 Routine Culture of Microorganisms .....	37
2.1.1 Bacterial strains and culture media .....	37
2.1.2 Glycerol stocks of bacteria .....	38
2.1.3 Calculation of total viable counts (TVCs) .....	38
2.2 Molecular Biology Methods .....	39
2.2.1 Extraction of chromosomal DNA .....	39
2.2.2 Polymerase chain reaction (PCR) .....	40
2.2.3 Agarose gel electrophoresis .....	42
2.2.4 Nanodrop spectrophotometry .....	42
2.2.5 Cloning in the PCR2.1-TOPO vector .....	42
2.2.6 Plasmid extraction and sequencing .....	43
2.2.7 Measurement of DNA concentration by PicoGreen .....	43
2.2.8 Quantitative PCR .....	43
2.3 Biofilm Models .....	44
2.3.1 Static biofilm model .....	44
2.3.2 Biofilm model using the Modified Robbins Device (MRD) .....	44
2.4 Preparation of Tooth Section Studs .....	48
2.4.1 Preparation of silicone models .....	48
2.4.2 Preparation of tooth section .....	48
2.4.3 Preparation of composite studs with tooth sections .....	49
2.5 Fluorescence Labelling .....	50
2.5.1 Labelling of bacterial cells by Fluorescence In Situ Hybridisation (FISH) .....	50
2.5.2 Exopolysaccharide (EPS) labelling .....	51
2.5.3 Extracellular DNA (eDNA) labelling .....	51
2.6 Microscopy .....	51
2.6.1 Scanning electron microscopy (SEM) .....	51

2.6.2 <i>Epifluorescence microscope</i> .....	52
2.6.3 <i>Confocal Laser scanning microscopy (CLSM)</i> .....	52
2.7 Statistical Analysis .....	53
<b>Chapter 3. Establishment of Early Coloniser Mixed Species Biofilms .....</b>	<b>55</b>
3.1 Outline and Aims .....	55
3.2 Development of Monospecies Biofilms .....	58
3.2.1 <i>SEM of monospecies biofilms</i> .....	58
3.3 Development of Early Coloniser Mixed Species Biofilms .....	60
3.3.1 <i>Development of qPCR assays to enumerate different species</i> .....	60
3.3.2 <i>Enumeration of bacterial cells in early coloniser mixed species biofilms</i> .....	64
3.3.3 <i>SEM of early coloniser mixed species biofilms</i> .....	66
3.3.4 <i>Comparison of tooth surfaces versus biostuds as biofilm substrate by SEM</i> .....	66
3.4 Discussion .....	68
<b>Chapter 4. Incorporation of <i>S. mutans</i> UA159 into Preformed Biofilms ....</b>	<b>75</b>
4.1 Outline and Aims .....	75
4.2 Development of <i>S. mutans</i> UA159 Monospecies Biofilms .....	78
4.2.1 <i>Development of qPCR assay to enumerate <i>S. mutans</i> in biofilms</i> .....	78
4.2.2 <i>Quantification of <i>S. mutans</i> UA159 in the monospecies biofilm by qPCR</i> .....	79
4.2.3 <i>SEM of <i>S. mutans</i> UA159 monospecies biofilms</i> .....	80
4.2.4 <i>Visualisation of EPS in <i>S. mutans</i> UA159 monospecies biofilms using fluorescent dye and CLSM</i> .....	80
4.3 Incorporation the <i>S. mutans</i> UA159 within the Preformed Early Coloniser Mixed Species Biofilm .....	82
4.3.1 <i>Quantification of different species in biofilms following challenge with <i>S. mutans</i> UA159</i> .....	82
4.3.2 <i>Comparison between the levels of <i>S. mutans</i> UA159 in monospecies and mixed species biofilms</i> .....	83
4.3.3 <i>FISH labelling of <i>S. mutans</i> UA159</i> .....	84

4.3.4 SEM of mixed species biofilms.....	90
4.4 Discussion.....	92
<b>Chapter 5. Integration of <i>S. mutans</i> GS5 into Early Colonisers Mixed Biofilms with <i>S. gordonii</i> (Wild-Mutant).....</b>	<b>97</b>
5.1 Outline and Aims .....	97
5.2 Inoculation of <i>S. mutans</i> GS5 into Preformed Mixed Biofilms with Wild-Type <i>S. gordonii</i> DL1.....	100
5.2.1 Quantification of <i>S. mutans</i> GS5 in mixed species biofilm by qPCR.....	100
5.2.2 Comparison of the quantification of <i>S. mutans</i> GS5 and UA159 in mixed species biofilm.....	101
5.2.3 Detection of <i>S. mutans</i> GS5 integration in mixed species biofilm by FISH.....	101
5.2.4 SEM of mixed species biofilm.....	105
5.2.5 Visualisation of EPS in mixed species biofilms with <i>S. mutans</i> GS5 by CLSM	107
5.3 Development of Early Coloniser Mixed Species Biofilms with.....	109
5.3.1 Comparison of bacterial cell numbers in early coloniser mixed species biofilm with <i>S. gordonii</i> DL1 Vs <i>S. gordonii</i> <i>ssnA</i> (DNase) mutant.....	109
5.4 Inoculation of <i>S. mutans</i> GS5 within Preformed Mixed Species Biofilms with Mutant <i>S. gordonii</i> <i>ssnA</i> .....	110
5.4.1 Quantification of <i>S. mutans</i> GS5 in mixed species biofilms with <i>S. gordonii</i> <i>ssnA</i> by qPCR.....	110
5.4.2 Levels of <i>S. mutans</i> GS5 in mixed species biofilms with <i>S. gordonii</i> DL1 or <i>S. gordonii</i> <i>ssnA</i> with and without 0.1% sucrose.....	111
5.4.3 Detection of <i>S. mutans</i> GS5 in mixed species biofilms containing <i>S. gordonii</i> <i>ssnA</i> by FISH .....	112
5.4.4 SEM of mixed species biofilms with <i>S. gordonii</i> <i>ssnA</i> before and after inoculation of <i>S. mutans</i> GS5.....	116
5.4.5 Visualisation of EPS in mixed species biofilms containing <i>S. gordonii</i> <i>ssnA</i> and <i>S. mutans</i> GS5 with and without 0.1% sucrose by CLSM.....	118

5.4.6 <i>Fluorescent labelling and CLSM imaging of eDNA in mixed species biofilms with S.gordonii ssnA and S. mutans GS5 with and without 0.1% sucrose</i> .....	120
5.5 Discussion .....	122
<b>Chapter 6. Overall Perspective</b> .....	<b>127</b>
6.1 General Discussion .....	127
6.2 Suggestion for Future Work.....	131
Appendix .....	133
<i>Appendix A: Conference and meeting attendance, and public engagement</i> .....	133
Reference .....	137

## List of Figures

Figure 1. 1 The interaction of different factors associated with the development of dental caries. ....	3
Figure 1. 2 Dynamic processes of demineralization and remineralisation. ....	6
Figure 1. 3 Schematic representation of demineralization and subsequent remineralisation to form crystals with more resistance to acidic attack and less susceptibility to solubility in comparison to original mineral. ....	7
Figure 1. 4 A diagram illustrating the stages of biofilm development on the tooth surface....	13
Figure 1. 5 Examples of different <i>in vitro</i> systems for growing biofilm. ....	35
Figure 2. 1 Flow diagram demonstrating the molecular biological methods.....	39
Figure 2. 2 Modified Robbins Devices (MRD). ....	46
Figure 2. 3 Preparation of a negative copy of a stainless steel biostud, using silicon rubber base impression material.....	48
Figure 2. 4 Preparation of the composite stud with tooth section.....	49
Figure 3. 1 SEM images of monospecies biofilms cultured without sucrose (left panels), and with 0.1% sucrose (right panels).....	59
Figure 3. 2 Agarose gel electrophoresis of an amplified <i>V. parvula</i> PK1910 PCR fragment, and a negative control. ....	60
Figure 3. 3 Diagram demonstrating the TOPO cloning of the PCR amplified <i>V. parvula</i> PK1910 16S rRNA gene. ....	61
Figure 3. 4 Gel electrophoresis of PCR-Vp. ....	62
Figure 3. 5 PicoGreen standard curve to measure the concentration of template DNA. ....	62
Figure 3. 6 (A) qPCR standard curve example of ten-fold serial dilutions of <i>V. parvula</i> PK1910 standard plasmid, (B) individual amplification. ....	63
Figure 3. 7 Gel electrophoresis of the three pioneer bacterial species plasmids. ....	64
Figure 3. 8 Quantification of bacterial cells in early coloniser mixed species biofilms. ....	65
Figure 3. 9 SEM images of early coloniser mixed species biofilms, without sucrose (a), and with 0.1% sucrose (b).....	66
Figure 3. 10 SEM images of early coloniser mixed species biofilms developed on tooth sections in the MRD without and with 0.1% sucrose (a, c), in comparison to stainless steel biostuds (b, d).....	67

Figure 4. 1 Gel electrophoresis of PCR fragment amplified from pTOPO-Sm with primers gtfB F/R and probe gtfB P.....	78
Figure 4. 2 Quantitative PCR determination of <i>S. mutans</i> UA159 in monospecies biofilms developed in the MRD without and with 0.1% sucrose for 24 h.....	79
Figure 4. 3 SEM images of <i>S. mutans</i> UA159 in monospecies biofilms without sucrose (a), and with 0.1% sucrose (b). .....	80
Figure 4. 4 CLSM images of monospecies <i>S. mutans</i> UA159 to show the exopolysaccharide (EPS) substance in biofilm matrix.....	81
Figure 4. 5 Quantification of <i>S. mutans</i> UA159 cells with other three pioneer species in mixed species biofilms by qPCR.....	82
Figure 4. 6 Comparison of levels of early colonisers in biofilms without or with <i>S. mutans</i> UA159 present, with and without sucrose.....	83
Figure 4. 7 Comparison of <i>S.mutans</i> UA159 cells within mixed species and monospecies biofilms without and with 0.1% sucrose. ....	84
Figure 4. 8 Epifluorescence Microscope images of the bacterial cells labelled by FISH. ....	85
Figure 4. 9 CLSM images of mixed species biofilms before (left panels), and after (right panels) inoculation of <i>S. mutans</i> UA159.....	87
Figure 4. 10 Sectioning CLSM imaging of FISH-labelled biofilms before being challenged with <i>S. mutans</i> UA159.....	88
Figure 4. 11 Sectioning CLSM imaging of FISH labelled biofilms after <i>S. mutans</i> UA159 challenging. ....	89
Figure 4. 12 SEM images of mixed species biofilms before (a, b), and after (c, d) inoculation of <i>S. mutans</i> UA159. ....	91
Figure 5. 1 Quantification of <i>S.mutans</i> GS5 cells and other pioneer species within mixed biofilms.....	100
Figure 5. 2 Comparison of the quantification of <i>S.mutans</i> UA159, and <i>S.mutans</i> GS5 cells within mixed species biofilms without and with 0.1% sucrose.....	101
Figure 5. 3 CLSM images of mixed species biofilms before (left panels), and after (right panels) challenge with <i>S. mutans</i> GS5. ....	102
Figure 5. 4 Sectioned CLSM imaging of FISH detection biofilms before <i>S. mutans</i> GS5 inoculation. ....	103
Figure 5. 5 Sectioned CLSM imaging of FISH detection biofilms after <i>S. mutans</i> GS5 inoculation. ....	104

Figure 5. 6 SEM images of mixed species biofilms before (a, b), and after (c, d) challenging with <i>S.mutans</i> GS5.....	106
Figure 5. 7 CLSM images of mixed species biofilms with <i>S.mutans</i> GS5 to show the exopolysaccharide (EPS) substance in the biofilms matrix.....	108
Figure 5. 8 Comparison between the quantification of bacterial cells in early coloniser mixed species biofilms with <i>S. gordonii</i> DL1 Vs <i>S. gordonii ssnA</i> .....	109
Figure 5. 9 Quantification of <i>S. mutans</i> GS5 cells in mixed species biofilms with <i>S.gordonii ssnA</i> . Numbers of bacterial cells were quantified by qPCR. ....	110
Figure 5. 10 Comparison between the quantification of <i>S. mutans</i> GS5 in mixed species biofilms with <i>S. gordonii</i> DL1 vs <i>S. gordonii ssnA</i> , with and without 0.1% sucrose.....	111
Figure 5. 11 CLSM images for mixed species biofilms containing <i>S. gordonii ssnA</i> before (left panels), and after (right panels) inoculation of <i>S. mutans</i> GS5.....	113
Figure 5. 12 CLSM sectioning imaging of biofilms labelled by FISH probes. ....	114
Figure 5. 13 CLSM sectional imaging of biofilms labelled by FISH probes. ....	115
Figure 5. 14 SEM images of mixed species biofilms before (a, b), and after (c, d) inoculation of <i>S. mutans</i> GS5.....	117
Figure 5. 15 CLSM images of mixed species biofilm with <i>S. gordonii ssnA</i> , and inoculated <i>S. mutans</i> GS5, to show EPS of the biofilm matrix. ....	119
Figure 5. 16 Fluorescent labelling of the biofilms matrix eDNA. ....	121



## List of Tables

Table 2. 1 Bacterial strains used in this study. ....	37
Table 2. 2 PCR primers and qPCR primers and probes used in this study. ....	41
Table 2. 3 FISH PNA molecular probes used in this study. ....	51
Table 2. 4 Excitation/Emission of fluorescence dyes used in this study. ....	53
Table 3. 1 Efficiency of qPCR standard curve for each standard plasmid ten-fold dilution of species used in this study. ....	63

## List of Abbreviations

°C	Centigrade
µg/ml	Microgram/millilitre
µl	microliter
3D	Three dimensions
AI-2	Autoinducer-2
AMM	Artificial mouth models
AMPs	Antimicrobial peptides
ATPase	Adenosine triphosphatase
ATR	Acid tolerance response
BHI	Brain Heart Infusion
bp	Base pairs
Ca	Calcium
CBD	Calgary Biofilm Device
CDFF	Constant Depth Film Fermenter
CFU	Colony Forming Units
CFU/ml	colony forming unit/millilitre
CFW	CalcoFluor White
CHX	Chlorhexidine
CLSM	Confocal Laser Scanning Microscope
CO <sub>2</sub>	Carbon dioxide
CPD	Critical Point Dryer
CSP	Competence stimulating peptide
CSP/XIP	competence-stimulating/ inducing peptides
DAPI	4',6-diamidino-2-phenylindole
DexA	Dextranase A
DGGE	Denaturing gradient gel electrophoresis
DM	Demineralisation
DMSO	Dimethyl sulfoxide
DNA	Deoxyribonucleic acid
DNase	Deoxyribonuclease
dsDNA	Double stranded deoxyribonucleic acid

ECC	Early childhood caries
eDNA	Extracellular deoxyribonucleic acid
EDTA	Ethylenediaminetetraacetic acid
EMA	Ethidium monoazide
EPS	Exopolysaccharides
F	Forward
FISH	Fluorescent <i>in situ</i> hybridisation
FruA	Fructanase A
FTF	Fructosyltransferase
g	Gram
g/ml	Gram/millilitre
g/L	Gram/litre
GbpA	Glucan binding protein A
GbpB	Glucan binding protein B
GbpC	Glucan binding protein C
Gbps	Glucan binding proteins
GtfB	Glucosyltransferase B
GtfC	Glucosyltransferase C
GtfD	Glucosyltransferase D
GTFs	Glucosyltransferases
h	Hour
H <sup>+</sup>	Hydrogen ions
H <sub>2</sub>	Hydrogen
H <sub>2</sub> O	Water
H <sub>2</sub> O <sub>2</sub>	Hydrogen peroxide
H <sub>2</sub> PO <sub>4</sub> <sup>2-</sup>	Dihydrogen phosphate ion
HA	Hydroxyapatite
HCL	Hydrochloric acid
HPO <sub>4</sub> <sup>2-</sup>	Hydrogen Phosphate Ion
HSL	Homoserine lactones
IPS	Intracellular storage polysaccharides
kb	Kilobases

LB	Luria Bertani
LP	Long Pass
MEGA6	Molecular Evolutionary Genetics Analysis6
min	Minute
mL	Millilitre
mm	Millimetre
mM	Millimolar
mm <sup>2</sup>	Square millimetre
MRD	Modified Robbins Device
NaOH	Sodium hydroxide
NCBI	National Center for Biotechnology Information
nm	Nanometres
nM	Nanomolar
OD	Optical Density
OH <sup>-</sup>	Hydroxyl ions
P	Probe
PAc	Cell-surface protein antigen
PBS	Phosphate buffered saline
PCR	Polymerase Chain Reaction
PI	Propidium iodide
PMA	Propidium monoazide
PNA	Peptide nucleic acid
PO <sub>4</sub> <sup>3-</sup>	Phosphate ions
PRPs	Proline-rich proteins
qPCR	Quantitative polymerase chain reaction
QS	Quorum sensing
R	Revers
RM	Remineralisation
rpm	Revolutions per minute
rRNA	Ribosomal RNA
S.O.C	Super Optimal broth with Catabolite
SAG	Glycoprotein salivary agglutinin complex

Sec	Second
SEM	Scanning Electronic Microscopy
SHI	Schenk and Hildebrandt
SpaP	Cell-surface protein antigen P
spp.	Species
SsnA	Streptococcal secreted nuclease A
SsnA	<i>Streptococcus suis</i> nuclease A
T&C	Tissue and cells
TAE	Tris/acetate, EDTA
TE	Tris-HCL, EDTA
THYE	Todd Hewitt Yeast Extract
TVCs	Total Viable Counts
U/mL	Unit/millilitre
UK	United Kingdom
USA	United States of America
UV	Ultraviolet
v	Volt
v/v	Volume/volume
w/v	Weight/volume
WapA	Wall-associated protein A
WapE	Wall-associated protein E
WHO	World Health Organisation
x g	G-force
X-gal	5-bromo-4-chloro-3-indolyl- $\beta$ -D-galactopyranoside
XIP	Sigma X-inducing peptide
$\lambda$	Lambda



## Chapter 1. Introduction

Dental caries (tooth decay) is a chronic infectious disease, and is the most prevalent disease among humans worldwide (Kassebaum *et al.*, 2017). It compromises people throughout their lifetime, not only during childhood or adolescence (Strużycka, 2014). The pathological condition of tooth decay can either begin at the enamel of the tooth crown or at the cementum or dentine covering the root, causing decalcification and disintegration of these dental tissues (Karpiński and Szkaradkiewicz, 2013). Dental plaque is an example of an oral biofilm, which is considered to be a necessary factor in the aetiology of dental caries. This plaque is an aggregation of bacteria embedded in exopolysaccharides and other extracellular polymers which bind to the tooth surface (Bowden and Li, 1997; Marsh *et al.*, 2011; Koo *et al.*, 2013). Naturally, the dental plaque accumulates at certain sites on tooth surfaces, and can reach a state of ‘maturation’ after one to two days in the absence of oral hygiene (Santos, 2003). Control of the bacterial biofilm on teeth is necessary for the preservation of oral health.

Evidence from epidemiological, animal, and *in vitro* studies indicate that different bacterial species can be involved in the development of dental caries, such as oral streptococci, especially of the mutans group, *Lactobacillus* spp., members of the *mitis*, *anginosus* and *salivarius* groups of *Streptococcus*, as well as *Propionibacterium*, *Enterococcus faecalis* and *Scardovia* (Tanzer *et al.*, 2001; Wade, 2013). Among these species, the *Streptococcus mutans* remains the species that is most strongly associated with dental caries (Teng *et al.*, 2015). *S. mutans* can rapidly produce lactic acid from dietary carbohydrates, mainly sucrose and glucose (Van Houte *et al.*, 1991; Islam *et al.*, 2007). The creation of such an acidic environment makes *S. mutans* capable of demineralising hard tissue on teeth (Loesche, 1986; Islam *et al.*, 2007). *S. mutans* is always present in a mixed-species environment, and the impact of other species on *S. mutans* colonisation, acid production and enamel demineralisation is only beginning to be understood.

## 1.1 Dental Caries

The term dental caries refers to both the dynamic process of caries development, and the carious lesion (cavitated or non-cavitated) that occurs upon a tooth's surface as a result of acid production by mature dental plaque bacteria (Selwitz *et al.*, 2007). Microorganisms in mature dental plaque produce acids from dietary carbohydrate. This acid can dissolve the hydroxyapatite of the hard tissues of the tooth (enamel, dentine, and cementum), and once hard tissues are progressively destroyed, subsequent cavity formation results. An untreated cavity can progress to endodontic infection or an abscess (Wade, 2013). Although it is one of the most prevalent chronic diseases worldwide that affects both children and adults, it is still a preventable disease (Pitts, 2004).

The actual environment for the initiation of the carious process starts within the bacterial biofilm (dental plaque) that accumulates and develops on the tooth's surface (Selwitz *et al.*, 2007). Frequent intake of dietary sugars disturbs the 'microbial homeostasis' in dental plaque and leads to the overgrowth of species that produce acid from the fermentation of dietary carbohydrates, and which favour living in an acidic environment, such as *S. mutans* and lactobacilli. The presence of these species in dental plaque then increases the exposure of the enamel surface to acid, causing the gradual dissolution of the tooth surface (Pitts, 2004; Wade, 2013).

Early demineralisation changes in the enamel surface during the initial stages of caries may not be identified by conventional clinical and radiographic methods (Kidd and Fejerskov, 2004). In the initial stages of caries, enamel may be remineralised, thus arresting the disease process. If an early enamel lesion is not remineralised it will progress and cause tooth destruction (Pitts, 2004). The progression of caries is characterised by the appearance of demineralisation features on the hard dental tissue as 'chalky' white spot lesions. Dental caries can range from a lesion that is subsurface and subclinical to a lesion which appears as frank cavitation (Selwitz *et al.*, 2007).



### 1.1.1 Aetiology of dental caries

Dental caries is a multifactorial disease where the aetiological process is complex. Interaction between various factors can initiate the development and progression of dental caries (Cummins, 2013). Factors which may have a bearing upon an individual's caries status are broadly categorised into: personal factors, oral environmental factors, and factors that directly contribute to caries development (Figure 1. 1) (Selwitz *et al.*, 2007).

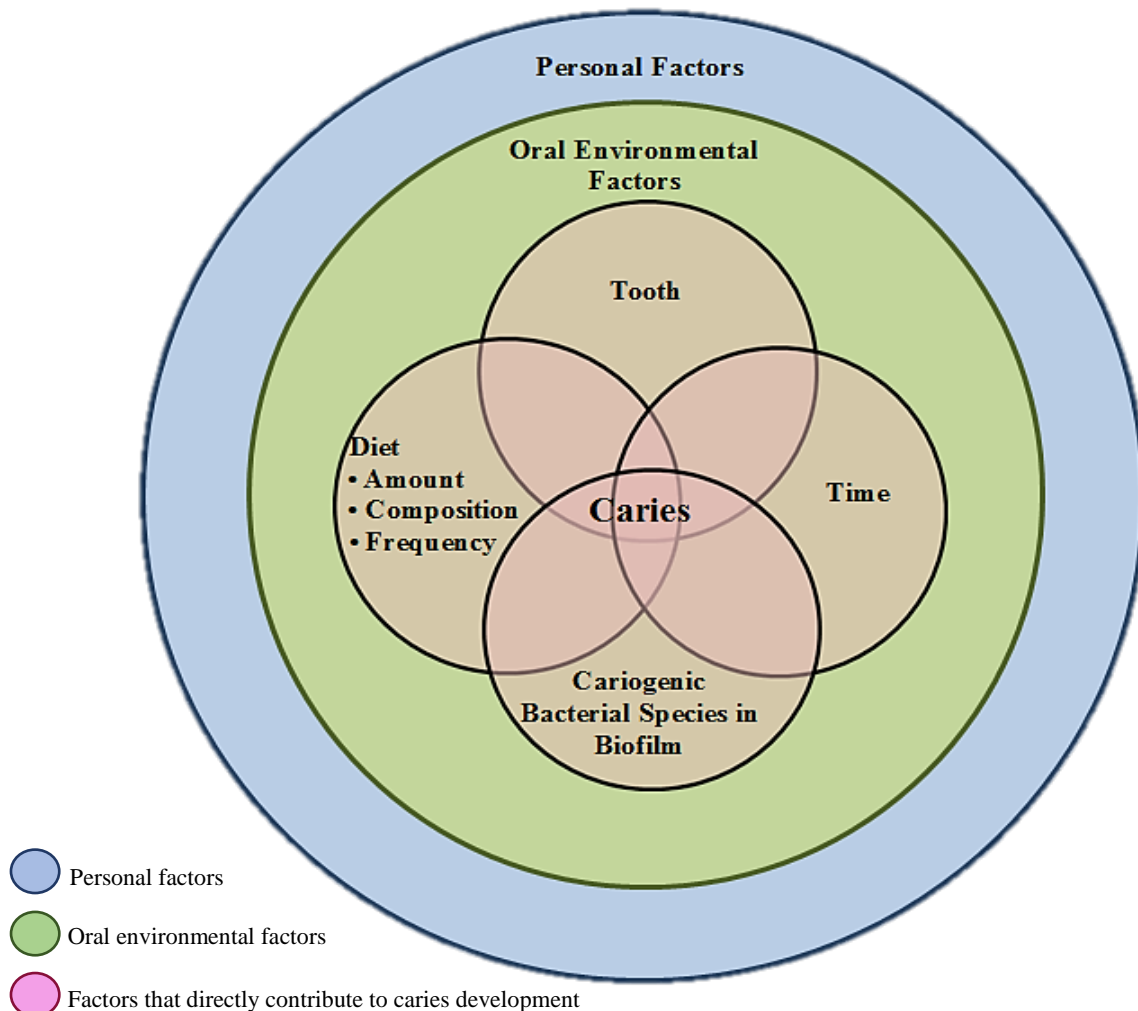

Figure 1. 1 The interaction of different factors associated with the development of dental caries. Adapted from Selwitz *et al.* (2007).

Dental caries develops over time by the activity of microorganisms that form acidic by-products as a result of their metabolic action (Fontana *et al.*, 2010). Host factors including tooth surface and saliva act as substrate where these microorganisms accumulate and dental biofilm is established; ingested food particles, specifically sugars, can play an important role in the aggressiveness of this dental biofilm bacterial community (Sánchez-Pérez *et al.*, 2010). Changes in environmental factors that cause caries can lead to changes in the dental biofilm ecosystem from a state of equilibrium to imbalance, which may favour the growth of

cariogenic bacterial species, such as acidogenic and aciduric species (Marsh, 2006; Kidd, 2011).

The presence of cariogenic bacteria within the dental biofilm is necessary to progress the development of the caries. Mutans streptococci and Lactobacilli species, and Bifidobacteria, including *Scardovia wiggisiae*, are cariogenic bacterial species reported to be greatly involved in the development of dental caries (Tanner *et al.*, 2011a; Kaur *et al.*, 2013). The bacterial strains in the biofilm metabolise fermentable carbohydrates, and produce weak organic acid by-products. These acids include lactic, acetic, formic and propionic, and have been demonstrated to produce demineralisation of the inorganic parts of enamel and dentine (Fejerskov, 2004; Cummins, 2013). Thus, the pH at the tooth surface drops below the critical pH of the tooth tissue (for enamel pH 5.5, for dentine pH 6.4), resulting in tooth surface demineralisation (Featherstone, 2004). Frequent cycles of demineralisation of tooth structures can cause dissolution of tooth mineral components such as calcium, phosphate, and carbonate, and thus eventually tooth cavitation can occur (Featherstone, 2004; Cummins, 2013). As a lesion progresses, acids gain access to deeper layers causing further dissolution (Selwitz *et al.*, 2007), in a process that may take several months or even years.

Clearly, several factors are important in the caries process: (i) the bacterial composition of dental plaque, and the predominance of certain cariogenic species; (ii) diet and the consumption of a diet high in free or non-milk extrinsic sugars, which supplies the cariogenic bacteria with an appropriate nutrient; (iii) tooth surface susceptibility, whether smooth surface or pit and fissure surface; and (iv) saliva, for example the concentration of  $\text{Ca}^{2+} + \text{PO}_4^{3-}$  ions, which may aid remineralisation of enamel. Saliva also contains hydrogen carbonate, which acts as a buffer for pH, and several antimicrobial proteins. The demineralisation and remineralisation activity at the enamel surface is therefore complex (Kutsch and Cady, 2009; Fontana *et al.*, 2010).

### ***1.1.2 Mechanism of dental caries development***

Tooth enamel is initially comprised of hydroxyapatite crystals (HA) of chemical composition  $\text{Ca}_{10}(\text{PO}_4)_6(\text{OH})_2$ , surrounded by calcium, phosphate, and fluoride minerals derived from oral fluids (Dawes, 2003). In neutral pH, there is a dynamic balance between the tooth mineral contents and the oral fluid mineral. Saliva plays an essential role in maintaining the health of soft and hard tissues in the oral cavity (Zero *et al.*, 2009). The quality and quantity of saliva and its buffering properties affect the dissolution and precipitation of enamel HA crystals.

Saliva is a supersaturated solution with respect to calcium and phosphate, and this is essential to prevent the demineralisation of the hydroxyapatite crystal lattice (Usha and Sathyanarayanan, 2009).

As mentioned previously, the development of dental caries is initiated when acidogenic bacteria in the dental biofilm begin to produce an acidic environment from available dietary sugars. In response to such acidic production, a rapid drop from a neutral pH of 7.0 to acidic pH 5.0 or even less occurs within the fluid of the enamel biofilm (Featherstone, 2004). When the enamel surface is exposed to fluid below the critical pH (5.5), there is a net loss of hydroxyapatite. When the pH level of the oral environment becomes acidic, most of the phosphate ions ( $\text{PO}_4^{3-}$ ), and the hydroxyl ions ( $\text{OH}^-$ ) tend to react with the hydrogen ions ( $\text{H}^+$ ) derived as a result of interference between tooth and dental plaque biofilm, and form chemical compounds like  $\text{HPO}_4^{2-}$  and  $\text{H}_2\text{O}$  (Usha and Sathyanarayanan, 2009; Chen and Wang, 2010). A further combination of hydrogen ions ( $\text{H}^+$ ) with  $\text{HPO}_4^{2-}$  occurs under more acidic oral environment conditions that can be created by the bacterial metabolic activity to form a more acidic compound when the dietary carbohydrates are available to form a compound, which is  $\text{H}_2\text{PO}_4^{2-}$  (Usha and Sathyanarayanan, 2009), as a result of the dissolution of tooth enamel hydroxyapatite crystals, which occurs as follows:

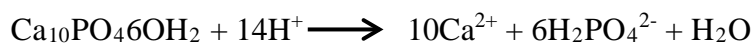

This locally occurring acidity is buffered again by oral fluids, the procedure of buffering; the dynamic equilibrium of minerals is an example of what happens in the demineralisation/remineralisation process (Dawes, 2003; Usha and Sathyanarayanan, 2009).

In the oral environment, the teeth are continuously affected by dynamic demineralisation and remineralisation processes. When the pH of the biofilm returns to neutral pH by the buffering activity of saliva, remineralisation frequently begins to occur (Selwitz *et al.*, 2007). The equilibrium between demineralisation and remineralisation is responsible for dental caries progression, arrest or reversal (Aoba, 2004; Chen and Wang, 2010). Each period of demineralisation is interrupted by a remineralisation period in a dynamic interaction process. When there is an adequate interval between the acidogenic challenges, demineralisation effects can be reversed to allow the remineralisation and repair of an enamel lesion. The demineralisation and remineralisation processes occur frequently in most people (Aoba, 2004) (Figure 1. 2).

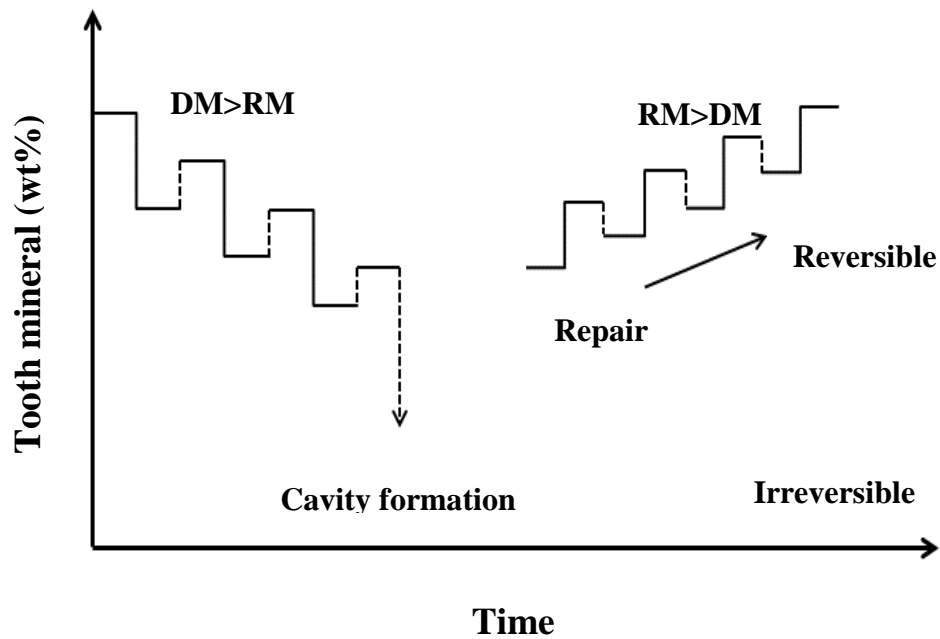

Figure 1. 2 Dynamic processes of demineralization and remineralisation. The possible consequences for the loss and gain of tooth mineral within a time interval, based on the predominance of demineralisation or remineralisation. Adapted from Aoba (2004).

Early detection of the caries process may reverse its progression by using either antibacterial methods or any preventive measures that accelerate remineralisation or depress demineralisation (Featherstone, 2004; Chen and Wang, 2010). The non-cavitated lesion may be repaired by the process of remineralisation and this depends on calcium and phosphate ions, and fluoride ions (if made available), becoming incorporated within the damaged enamel crystal lattice structure found within subsurface lesions affected by demineralisation (García-Godoy and Hicks, 2008). These ions rebuild crystals which possess a greater resistance to future acidic challenges (fluorapatite), and enamel structures present a more compact microscopic appearance as a result of acquiring salivary calcium and phosphate ions (Chen and Wang, 2010). In addition, these crystals can be more resistant to acidic attack and less susceptible to solubility in comparison to the original mineral (Featherstone, 2008) (Figure 1. 3).

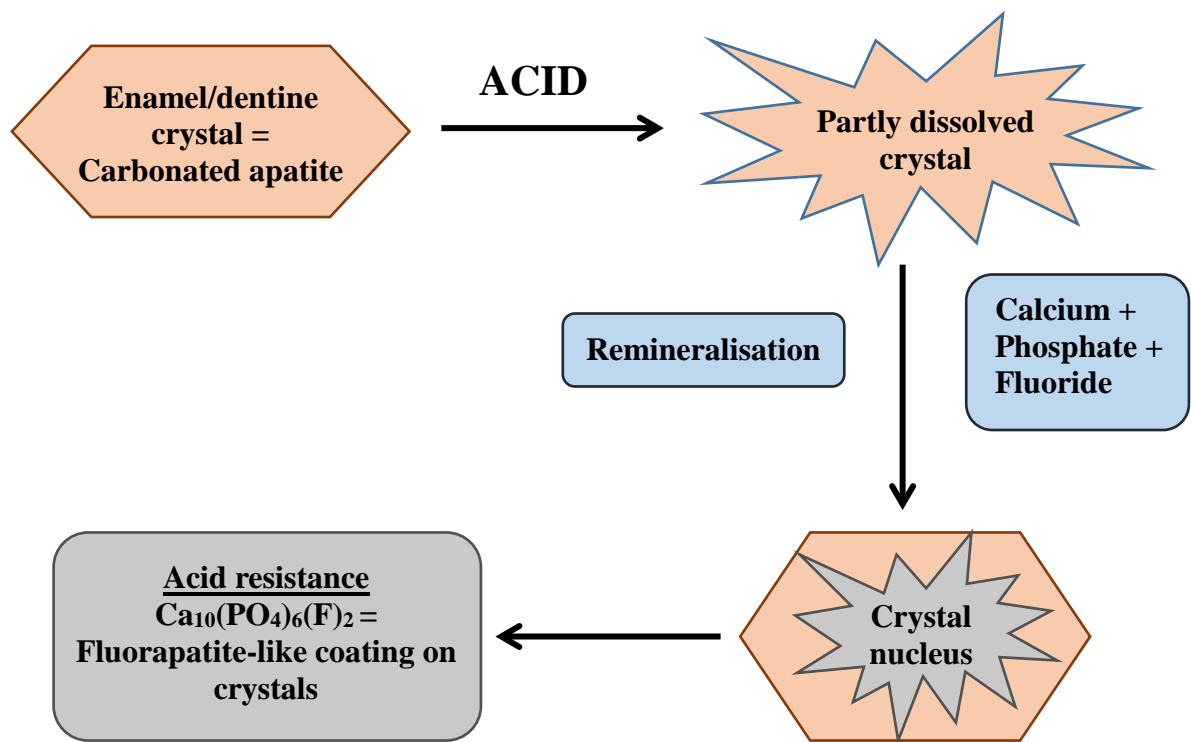

Figure 1. 3 Schematic representation of demineralization and subsequent remineralisation to form crystals with more resistance to acidic attack and less susceptibility to solubility in comparison to original mineral. Adapted from Featherstone (2008).

### 1.1.3 Dental caries in children

Dental caries in children, or early childhood caries (ECC), is considered to be one of the most prevalent biofilm-dependent infectious diseases worldwide (Hajishengallis *et al.*, 2017). Pre-school children under six, and toddlers of 12 months, can be affected by carious disease, which is particularly common in children of poor socioeconomic status (Dye *et al.*, 2015). Untreated carious lesions in children can cause extensive teeth cavitation and destruction, and rapidly cause painful, pulpitic symptoms, pulp necrosis and apical periodontitis. This is why it is considered to be a major public health challenge (Casamassimo *et al.*, 2009; Hajishengallis *et al.*, 2017).

Dental caries in children represents a crucial example of how the disease can consequently develop from highly cariogenic dental biofilms (Hajishengallis *et al.*, 2017). Such biofilms are established due to dynamic, complex interactions between the microorganisms of children's oral microflora, host, and diet. Soon after birth, and within the first months of infant life, the mouth of a germ-free baby becomes colonised with different bacterial species derived from exposure to the surrounding environment, specifically via contact with the mother, food ingestion, hygiene habits, and contact with other adults and children (Cephas *et*

*al.*, 2011). By the age of five months, the complexity of children's oral microflora has increased, and the oral environment significantly changes when the teeth erupt (Crielaard *et al.*, 2011; Xu *et al.*, 2015).

The eruption of teeth can provide new surfaces that act as niches for bacterial adhesion and accumulation, and a new ecological community can present in the oral environment (Sampaio-Maia and Monteiro-Silva, 2014). At this stage, some cariogenic *Streptococcus* species such as the *S. mutans* are thought to begin their colonisation, in a phase known as the 'window of infectivity,' which can occur based on the fact that the preferred adhesion surfaces for *S. mutans* are the tooth surfaces (Caufield *et al.*, 1993). Other studies have revealed that the colonisation of *S. mutans* in edentulous children, where the teeth have not yet erupted, potentially makes the oral soft tissue also act as substrate for the growth of *S. mutans*, rather than just the teeth surface (Gizani *et al.*, 2009; Cephas *et al.*, 2011). Thus, earlier monitoring of baby oral hygiene even before tooth eruption is very important.

Studies of the oral microflora of children aged three to twelve have suggested that the establishment of dental caries is not only related to a specific pathogenic bacterial species, but also to the whole bacterial population that colonises the tooth surface (Aas *et al.*, 2008; Gizani *et al.*, 2009; Kanasi *et al.*, 2010; Ling *et al.*, 2010; Tanner *et al.*, 2011b). Species such as *Streptococcus*, *Veillonella*, *Actinomyces*, *Propionibacterium*, *Granulicatella*, *Leptotrichia*, *Thiomonas*, *Bifidobacterium*, and *Atopobium* have been recorded as the pathological population associated with the occurrence of ECC in children, rather than any single species (Li *et al.*, 2007; Kanasi *et al.*, 2010; Ling *et al.*, 2010). Such microbial populations vary among different cariogenic lesions and degrees of cavitation (Richards *et al.*, 2017). Early coloniser species, such as *S. sanguinis*, *S. mitis*, and *S. oralis*, have been detected in the initial demineralisation of tooth enamel, while species like *S. mutans* and *Lactobacillus* were absent in such lesions (Takahashi and Nyvad, 2008; Ling *et al.*, 2010; Richards *et al.*, 2017). In enamel lesions, the non-mutans *Streptococci* and *Actinomyces* have been recognised as the predominant bacterial species, while *S. mutans* colonisation in white-spot lesions, although relatively low, but in comparison to clinically healthy sites, this relatively low number is considered to be high (Van Houte *et al.*, 1991; Richards *et al.*, 2017). In addition, it has been demonstrated that *S. mutans* colonisation with other acidogenic/aciduric bacterial species, such as *Scardovia wiggsiae*, *Parascardovia denticolens*, and *Lactobacillus salivarius*, are extensively predominant in active cariogenic lesions as well in caries cavitation in tooth dentine (Gross *et al.*, 2010; Tanner *et al.*, 2011b; Tanner, 2015). Thus, in the advanced stages

of dental caries in children, *S. mutans* is considered an important bacterial species associated within cariogenic lesions (Sampaio-Maia and Monteiro-Silva, 2014; Richards *et al.*, 2017).

#### ***1.1.4 Prevention of dental caries***

The main strategies of dental caries prevention aim firstly to prevent disease occurrence by improving oral health status (Moyer, 2014). Other preventive strategies may aim to arrest or reverse the establishment of the caries lesions, by either initiating protective factors or reducing the effect of pathological factors (Featherstone, 2004; Chen and Wang, 2010).

Dental caries prevention in children and adolescents is preferable to the treatment of dental caries and more cost-effective, and is thus considered a priority of dental services (Marinho *et al.*, 2013). When designing preventive treatment plans, one should consider the particular needs of each patient, and for all paediatric patients preventive care is a necessary constituent of treatment planning (Zero *et al.*, 2009).

The preventive strategies may not only be dependent on conventional ways and models of dental care. It is important to use an approach which utilises dental, medical, and other health care professional in its delivery. In addition to an individualised approach, the evaluation of public health should include measures of caries prevention. The carers of children play a primary role in the prevention of dental caries (Pahel *et al.*, 2011). In order to deal with either preventing or arresting carious lesions, different measures have been suggested. It is the responsibility of the dental professionals to select the appropriate preventive measures for each specific clinical situation, based on evidence from the patient's dental profile, and application of more than one measure may be required for caries prevention (Frencken *et al.*, 2012). These measures can include: (i) diet counselling and sugar substitutes; (ii) fluoridated agents, (iii) the infiltration method and (iv) pits and fissure sealants. These will now be addressed in more detail.

(i) Diet counselling and sugar substitutes: diet control is an important factor that can involve managing the establishment of a carious lesion in relation to the intake of sugars and other fermentable carbohydrates (Frencken *et al.*, 2012). Dietary control measures are most important for people at high risk of caries and for whom the practice of using different fluoride agents is unavailable (Frencken *et al.*, 2012). There are interactions between cariogenic food consumption, oral hygiene, and saliva availability, and fluoride can also lower the demineralisation of enamel and dentine due to the destructive effect of cariogenic food consumption (van Loveren and Duggal, 2001). Thus, using sugar alternatives such as xylitol

and sorbitol can help reduce cariogenic sugar consumption, and it has been demonstrated that chewing sugar-free gum with sugar substitute immediately after meals may reduce the progression of established cariogenic lesions (Chou *et al.*, 2013; Riley *et al.*, 2015).

(ii) Fluoridated agents: fluoride is a naturally available element found in water and plants (Petersen and Lennon, 2004; Keels *et al.*, 2008). It is of great importance in decreasing dental caries when applied systemically through its addition to water, milk, and salt, or topically by professional or self-application as a tooth paste, gel, varnish or mouthwash (Frencken *et al.*, 2012). Fluoride can minimise the dissolution of enamel and accelerate its remineralisation, and in addition it has antimicrobial effects at low pH levels (Lynch *et al.*, 2004; Chen and Wang, 2010). In systemic fluoride application, fluoridated water can reach whole communities (Iheozor-Ejiofor *et al.*, 2013; Carey, 2014). Fluoridated milk has been shown to have a beneficial effect on the permanent dentition of school children, and the same was demonstrated with the role of fluoridated salt and its prevention in caries in permanent dentition (Yeung *et al.*, 2005; Yengopal *et al.*, 2010; Frencken *et al.*, 2012). The application of fluoride topically via toothpaste, mouth rinses, gels, and fluoridated varnishes shows effectiveness in carious lesion incidents, regardless of using another fluoride route at the same time (Walsh *et al.*, 2009; Weyant *et al.*, 2013; Carey, 2014).

(iii) Infiltration method: this preventive measure has been suggested for non-cavitated carious lesions in enamel developed on buccal and proximal tooth surfaces (Paris *et al.*, 2007). The prevention concept of this application is based on infiltration of a low-viscosity resin material ('infiltrant') into the porosities of enamel lesion, etched by hydrochloric acid prior to resin application, and then hydrogen ions are diffused through barriers formed by the infiltrant. This prevents the progression of the existing carious lesion (Paris *et al.*, 2010). The superior effect of this application has been revealed when combined with fluoride varnish in the treatment of the proximal tooth surfaces of primary molars involved with superficial carious lesions (Ekstrand *et al.*, 2011). The arrest of lesions has been shown to be superior than when using fluoride varnish alone. However, such preventive efficiency was not shown in reducing the progression of the same carious lesion in permanent teeth (Martignon *et al.*, 2012). The available evidence on the preventive effect of the infiltration method on enamel lesions and further randomised clinical trials may make it a promising micro-invasive method that can be applied to reduce the progression of enamel lesions (Kielbassa *et al.*, 2009; Frencken *et al.*, 2012).



(iv) Pit and fissure sealants: the pits and fissures of a tooth's occlusal surface have been described as one of the main factors in caries risk due to their morphology (Powell, 1998). Thus, such risk has been frequently seen more with molars than in premolars (Feigal, 2002). Sealant strategies aim to convert the uneven surface of pits and fissures into a smooth surface that is easier to clean, and protects from the accumulation of hidden fermentable food substrate that can encourage the colonisation of bacteria (Feigal and Donly, 2006). Pit and fissure sealants not only act as a preventive measure, but can be effective in arresting the non-cavitated carious lesion in the enamel of the pit and fissure areas (Griffin *et al.*, 2008). Generally, resin composites and glass-ionomer cements are the most popular dental materials used as pit and fissure sealants (Ahovuo-Saloranta *et al.*, 2013). It has been reported that the preventive effect obtained from using pit and fissure sealants recorded superiority over the preventive effect achieved from the application of a fluoride varnish (Hiiri *et al.*, 2010; Ahovuo-Saloranta *et al.*, 2016).

## **1.2 Dental Plaque Biofilm**

Dental plaque represents a classic example of a mixed species biofilm community, in which up to 700 different species of bacteria interact with one another (Marsh, 2006). This bacterial community is embedded in a matrix of polymers that originates from the host and bacteria (Socransky and Haffajee, 2002; Marsh, 2004). Living in a biofilm community can make different bacterial species able to resist antibacterial agents 1,000 times more than living as planktonic cells (Zhang and Mah, 2008). Mediation of such resistance can be achieved by resilient intercellular matrices, slow growth of bacterial cells, and up-regulation of biofilm cells' antimicrobial systems (Zhang and Mah, 2008). Additionally, bacterial growth in biofilms and their tight adhesion mechanisms to the underlying substrate, make the removal of biofilms by physical or chemical methods difficult (Jakubovics and Kolenbrander, 2010).

Intact mature dental plaque is relatively stable, where there is a dynamic equilibrium of cooperative bacteria inside the community that maintains microbial homeostasis (Percival *et al.*, 2011). The bacterial colonisations of dental plaque biofilm accumulating on the soft and hard tissues of the oral cavity are continuously affected by changes in the condition of the surrounding environment (Marsh and Devine, 2011). The pH level, sucrose, and presentation of nutrient substances are important environmental factors that have been demonstrated to have profound effects on oral biofilms, which in turn can impact the pathogenicity of the dental biofilm (Burne and Marquis, 2000). As an example, when plaque is continuously exposed to a lowered pH level, this may cause the repression of acid-sensitive bacterial

species, and overgrowth of aciduric and acidogenic bacteria, such as Mutans streptococci and *lactobacilli*, which can have a crucial effect on the development of dental caries (De Soet *et al.*, 2000).

### ***1.2.1 Mechanism of dental plaque development***

The development of dental plaque occurs in organised stages that result in the establishment of a bacterial community containing different bacterial species, living inside highly organised structures, and functioning as a communal environment (Marsh, 2004). The early steps in biofilm establishment start with the adsorption of the saliva acquired pellicle on a tooth surface following cleaning (Forssten *et al.*, 2010); the cleaned enamel is coated with a mixture of complex components such as (glyco) proteins, including acidic proline-rich proteins, enzymes and mucins. Then, early colonising bacteria such as *Streptococcus gordonii*, *Actinomyces oris*, and *Veillonella* spp. attach to these components, forming a bacterial community (Kolenbrander *et al.*, 2010). Secondary colonisers such as *S. mutans* then attach to the primary colonisers community that has already formed through a co-adhesion process (Marsh, 2006). A rapid growth period then occurs and the biofilm matrix begins to form by the accumulation of water-insoluble extracellular polysaccharides and other extracellular polymers (Kaplan, 2010). Furthermore co-aggregation between different bacterial species is thought to promote the attachment of different species, thus leading to an increase in the complexity of the dental biofilm (Jakubovics and Kolenbrander, 2010; Reddy *et al.*, 2012).

Biofilm growth continues until maturation stage, which may take about 24h; at this stage, biofilm detachment can take place (Kolenbrander *et al.*, 2006; Kim *et al.*, 2014), and is recognised when the biofilm surface begins to separate and detach from the colonised surface (Hojo *et al.*, 2009) (Figure 1. 4). In addition, some colonies of bacterial cells detach and move to other areas and start to create new bacterial biofilms elsewhere in the mouth (Reddy *et al.*, 2012). Mature biofilms are essentially in a steady state and there is a balance between growth and detachment. In steady phase, the bacterial cells located deep in biofilm show the feature of slow growth or appear static, near to a non-vital appearance, while the bacterial cells that are positioned near the surface of the biofilm have been shown to remain intact (Reddy *et al.*, 2012). Areas of primary calculus mineralisation may appear as crystals and can be identified inside the inter-bacterial matrix (Gurenlian, 2007).

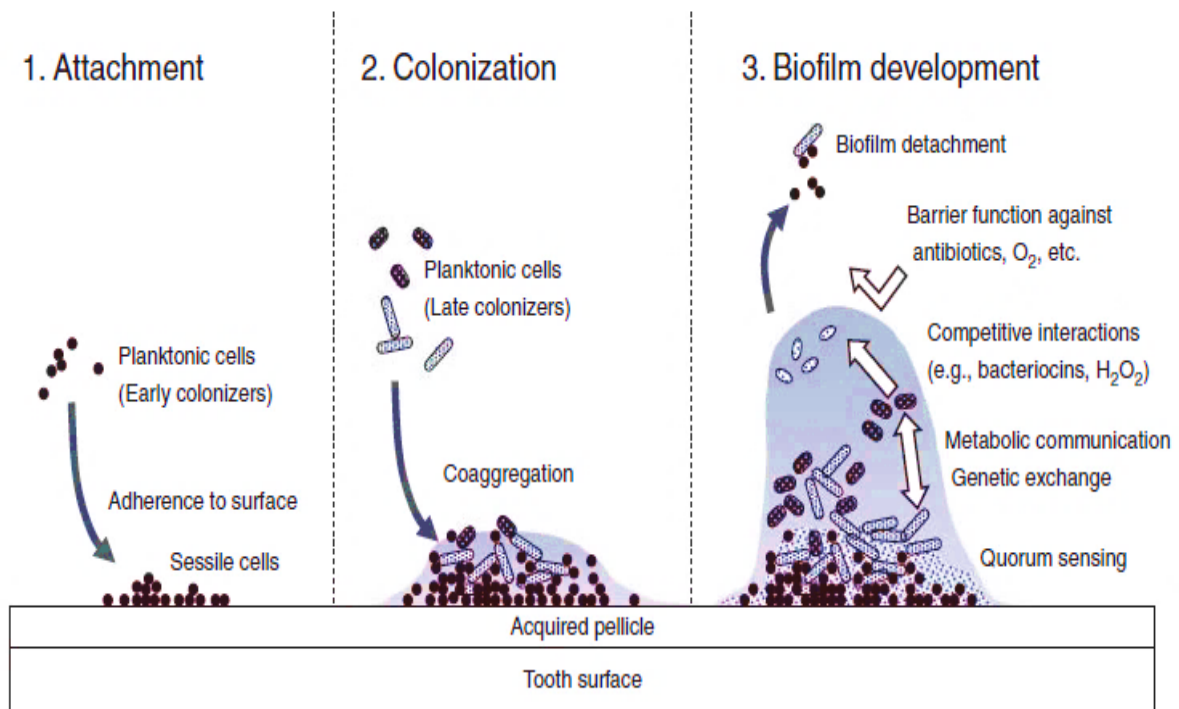

Figure 1. 4 A diagram illustrating the stages of biofilm development on the tooth surface. 1. Attachment of early colonisers with salivary pellicle. 2. Subsequent binding and colonisation is associated with cell-cell adhesion, known as coaggregation. 3. The mature biofilm contains areas of high bacterial cell density under different activities, including competitive interaction, metabolic communication, genetic exchange, and bacterial communication by quorum sensing. The biofilm community acts as a barrier towards antibiotics and oxygen. Image from Hojo *et al.* (2009).

### 1.2.2 Structure of dental plaque

The structure of dental plaque is complicated, as the aggregated bacterial cells as micro-colonies form about 15-20% of the biofilm volume. These micro-colonies are hydrated structures that have an affinity to combine chemically with water, and are spread within a matrix of polysaccharides, and other polymeric substances (Socransky and Haffajee, 2002). The mixed bacterial species of these colonies are surrounded by a biofilm matrix, and they are well organised in their distribution within the matrix. The dental plaque biofilm matrix is comprised mainly of water and aqueous dissolved substances derived from a combination of polysaccharides, protein, salts, and cell materials (Venkataramaiah and Biradar, 2011).

The polysaccharides are mainly formed by the bacterial species of biofilm, they are considered to be the major constituent of biofilm matrix (Xiao and Koo, 2010). It has been shown that with sucrose addition more polysaccharide can be produced in *S. mutans* UA159 monoculture biofilm developed on salivary coated hydroxyapatite discs under a flow system. Most biofilm matrices are enriched with polysaccharides, including dental biofilms. The

polysaccharides represent up to 40% of the dental biofilm dry weight (Xiao and Koo, 2010). Dental plaque biofilm polysaccharides can be categorised into two types: exopolysaccharides (EPS) and intracellular storage polysaccharides (IPS) (Koo *et al.*, 2003; Koo *et al.*, 2005; Leme *et al.*, 2006).

Exopolysaccharides are formed by bacterial glucosyltransferases (GTFs), which convert sucrose to glucans, or fructosyltransferases, which produce fructans from fructose (Hamada and Slade, 1980; Bowen, 2002). The EPS is a complicated structure that assists in supporting biofilm structures (see Section 1.3.6).

Intracellular polysaccharides act as an internal reservoir of carbohydrates, which are metabolised to form acids when there are intervals of nutritional substance deficiency (Allison, 2003; Branda *et al.*, 2005). Different bacterial species isolated from dental plaque have been demonstrated to have the ability to produce IPS, such as streptococci, diphtheroids, fusobacteria, and *Bacteroides* sp. (Gibbons, 1964). In addition, species such as *S. mutans*, *A. viscosus*, and *S. mitis* can produce lactic acid from IPS (Minah and Loesche, 1977). Intracellular polysaccharides are glycogen-like compounds of high molecular weight, including polymers with 1 $\alpha$ 4, and 1 $\alpha$ 6 glucosyl linkages that supply an endogenous source of carbohydrate to bacterial cells when there are periods of nutritional deficiency (Tanzer *et al.*, 1976; Leme *et al.*, 2006).

The cariogenic features of dental plaque biofilm are greatly affected by both EPS and IPS (Allison, 2003; Branda *et al.*, 2005; Lemos *et al.*, 2005). The influences of EPS and IPS on dental plaque biofilm cariogenicity have been clearly illustrated within at least two important pathways. Firstly, this occurs when EPS encourages bacterial attachment and aggregation on tooth surfaces, and leads to changes in the biochemical and structural characteristics of biofilm (Xiao *et al.*, 2012). Secondly, it occurs when IPS causes low fasting pH ranges during periods of nutritional deficiency, which, by turn, can cause a predominance of cariogenic bacteria and progression in caries development (Spatafora *et al.*, 1995).

Within dental plaque, different bacterial cells may rapidly multiply and seem to cause the enlargement of micro-colonies (Hentzer and Givskov, 2004). The growth and enlargement of the colonising community may be restricted by the availability of substrate. Variation in the appearance of bacterial micro-colonies is regulated by the shear forces resulting from the passage of fluid over the biofilm's surface (Venkataramaiah and Biradar, 2011). *In vivo*, the

developed dental plaque sample established by using an *in situ* device has demonstrated the formation of mushroom shapes, which frequently result from the distribution and size of the voids. It has a relatively narrow attachment at the base toward the enamel, with a larger biomass of biofilm more superior in position (Wood *et al.*, 2000).

Studies on biofilm voids have shown an appearance of structures resembling water channels located and connected between bacterial micro-colonies, acting as a rudimentary circulatory system. This primary circulatory system spreads on the biofilm and provides a facilitative flow of nutritional substances to interior areas within the biofilm, at the same time removing microbial waste products. This provides a suitable environment for the survival of mixed species bacterial micro-colonies within dental plaque biofilm (Costerton *et al.*, 1999; Paster *et al.*, 2006; Dige *et al.*, 2009). Dental plaque structure is an essential factor in categorising both the microbial physiology and indicating the ecology of the biofilm site, as the bacterial behaviour can be affected by biofilm thickness, density, biofilm structure openness, and the ratio of cell: matrix (Struzycka, 2014).

### ***1.2.3 Dental plaque and dental caries disease***

Carious lesions can develop under a mature dental plaque that coats a specific tooth surface for a long period (Peterson *et al.*, 2013), where some of the biofilm microorganisms that belong to the natural oral cavity flora can cause the lesion (see Section 1.1.1). The identification of caries pathogens is not easy as the pathological condition happens in areas that already include various aggregations of bacterial species, and the features that are related to cariogenicity, such as the production of acid, affinity to acidic environment, and the formation of intracellular and extracellular polysaccharide, are not only associated with single bacterial species (Beighton, 2005).

Bacterial micro-colonies of dental plaque biofilm are in close physical contact, and this structure is thought to be important for dental caries. Bacterial species in close proximity with one another in biofilms can form food chains with acidogenic bacterial species to regulate the outcome of their cariogenic influence (Marsh *et al.*, 1989; Marsh, 2006). There is evidence that species that utilise lactic acid such as *Veillonella* spp. benefit acid producers such as *S. mutans* as they limit acidification in the local environment (Kara *et al.*, 2007). However, eventually the accumulation of acidogenic species like *Streptococcus mutans*, and *Streptococcus sobrinus*, and *Lactobacilli*, or sometimes *Streptococcus salivarius*, or many

others, is dangerous in terms of dental caries as the rapid production of large quantities of acid close to the tooth surface will demineralise the enamel (Loesche, 1986; Becker *et al.*, 2002).

These bacterial species have the ability to metabolise sugars included in the daily diet to acid at a rapid rate, thus lowering the pH level locally (Sansone *et al.*, 1993; Brailsford *et al.*, 2001). In addition, the disease condition seems to be caused by the non-equilibrium of the mixed bacterial species community of biofilm as a result of selective growth circumstances within the surrounding bacterial community. Thus, entrapment with such a growth environment can have an effect on the control of competitive pathogenic bacterial species, that by turn can minimise the occurrence of oral diseases, especially the incidence of dental caries (Marsh, 2006).

#### ***1.2.4 Methods of dental biofilm control***

Control of dental biofilm is considered an important way to treat biofilm-related oral disease such as the dental caries (Jakubovics and Kolenbrander, 2010). Removing as much as possible from the accumulated dental plaque on the tooth surface may represent a primary step in plaque-related disease management. A further approach to control is by interfering with the accumulation of dental plaque by controlling microbial adhesion, interbacterial communication, or biofilm matrix establishment (Jakubovics and Kolenbrander, 2010; Panariello *et al.*, 2017).

Prevention of dental caries may be achieved by further understanding the complexity of biofilms are formed on tooth surfaces. Increasing salivary flow or activation of the secretion of protective salivary protein can cause an alteration in the oral microflora and increase oral defence mechanisms (Atkinson and Baum, 2001; Zheng *et al.*, 2001). Knowledge of the dental flora acts as a fundamental requirement for the development of dental caries preventive strategies. There are two clear targets for microbiological caries control. First, there is the symbiosis that exists among dental plaque bacterial community that may be established by either the probiotic microorganisms, which can have the ability to disturb the binding site between the host tissue (for example dental tissue) and other bacterial species (Meurman, 2005; Allaker and Douglas, 2009), or replacement therapy using bacterial species that compete with the pathogenic bacterial species in dental plaque and reduce their effect (Hillman *et al.*, 2000; Hillman, 2002). Second, since only a small number of dental flora organisms can cause caries, the objective is to disrupt their colonisation (Pahel *et al.*, 2011). The ability to identify the cariogenicity of dental biofilms and evaluate the metabolic

activities of the microbial community in dental biofilms can successfully manipulate the control of the progression of dental caries (Lingström *et al.*, 2000; Pretty *et al.*, 2005; Cagetti *et al.*, 2011).

Using antimicrobial agents in different forms such as pastes or mouth washes is considered to be one means of reducing dental plaque biofilm (Wolff and Larson, 2009). Fluoride forms such as stannous fluoride and amine fluoride, in addition to numerous metallic ions, have shown antimicrobial effectiveness (Gaffar *et al.*, 1997). A combination of fluoride, insoluble calcium compound, and arginine in toothpaste has the ability to reduce biofilm pathological factors when targeting dental plaque, and thus prevent the initiation of the caries process (Cummins, 2013; Fu *et al.*, 2013). Tooth brushing may not remove all the accumulated biofilm on surfaces, so the arginine activity here by deiminase the non-pathogenic arginolytic bacterial species pathway and recruit their ability to analyse the arginine to ammonia for neutralising the dental plaque acidity and keeping the unremoved biofilm intact. At the same time, the presence of calcium fluoride can enhance tooth remineralisation rather than demineralisation (Cummins, 2013).

Furthermore, chemoprophylactic agents such as chlorhexidine (along with other antimicrobial agents such as Triclosan and essential oils) have been used for many years as mouth washes, gels or varnishes to provide a longer inhibitory effect by the propriety of slow release of agents (Balakrishnan *et al.*, 2000; Chen and Wang, 2010; Frencken *et al.*, 2012). In spite of this, they all have drawbacks making their application limited, such as the tooth staining and calculus formation that can be caused by chlorohexidine (Chen and Wang, 2010). Things like vaccines, AMPs, and probiotics etc. are still experimental, but they may have potential (Chen and Wang, 2010; Frencken *et al.*, 2012). As long as the development in the destructive characteristics of caries process is associated with the cariogenicity of dental plaque (Lingström *et al.*, 2000), defining dental biofilm cariogenicity may be a useful aid that predicts the risk of dental caries (Cagetti *et al.*, 2011).

### **1.3 Oral Microflora**

The microflora inside the oral cavity represents the second most diverse bacterial population in the body (Kilian *et al.*, 2016). Over 700 different bacterial species have been shown to colonise different surfaces inside the oral cavity, such as the hard surfaces of teeth and the surfaces of oral mucosa soft tissue (Kilian *et al.*, 2016). The foetus at birth is germ-free, but the mouth rapidly becomes colonised with different bacterial species from the surrounding

atmosphere, and this occurs quickly after birth (Dominguez-Bello *et al.*, 2010). Aerobes and facultative species by the second day of life can be detected. Following the eruption of primary teeth, fastidious anaerobes have been recognised within the oral microflora (Sampaio-Maia and Monteiro-Silva, 2014).

The complexity of children's oral microflora increases with age (Crielaard *et al.*, 2011), and in addition the shedding of deciduous teeth and eruption of permanent teeth can make the oral environment change significantly (Xu *et al.*, 2015). The eruption of teeth and changes in levels of hormones that occur with development and ageing are associated with changes in the oral microflora, and the balance of different species within the oral community can be affected (Marsh *et al.*, 2015). Bacterial attachment is distributed among the mucosal tissue surfaces of the lips, palate, cheek, and tongue, as well as on hard tissue surfaces, i.e. teeth (Dewhirst *et al.*, 2010; Xu *et al.*, 2015). On teeth, supragingival dental plaque is above the gum line and is a primarily aerobic environment exposed to saliva, whereas subgingival dental plaque forms below the gum line and has lower oxygen tension and little or no exposure to saliva. Instead, subgingival dental plaque is fed by gingival crevicular fluid, a serum exudate (Marsh *et al.*, 2015).

The individual physical and biological characteristics within each tissue surface result in variation of the oral microflora composition. These include the existence of receptors facilitating the bacterial-surface linkage, the provision of bacterial nutritional needs, and the redox prospective of the attachment site (Marsh and Devine, 2011). These bacterial accumulations have been identified as host protective against the exogenous incursion of the pathogen (Ivanov and Honda, 2012), representing the native bacterial species of the oral microflora. Several of these species have been considered for their responsibility in causing two of the most widespread oral diseases, dental caries and periodontitis (Loesche, 1979; Rosier *et al.*, 2014). Therefore, oral health is relative to understanding the ecology of oral microflora and is important for the prevention and treatment of associated oral diseases (Keijser *et al.*, 2008). Additionally, systemic diseases such as bacterial endocarditis, aspiration pneumonia, osteomyelitis in children, preterm low birth weight, and cardiovascular disease are connected to definite bacterial species from oral microflora (Han and Wang, 2013).



### ***1.3.1 Microbial population of oral microflora***

Oral microflora or microbiota refers to all the microorganisms, and their collective genome, which exist in the human oral cavity (Chen and Jiang, 2014). Different bacterial species represent the predominant resident, and other oral microbiota include fungi, archaea, viruses and protozoa (Wade, 2013; Chen and Jiang, 2014). It is important to understand the diversity of oral microflora due to their involvement in oral health and disease (Takahashi and Nyvad, 2011). Microbial colonisation on host surfaces leads to the development of communities that are organised structurally and metabolically, known as biofilms. On the host surface, the microbial community within the established biofilm is exposed to different environmental conditions such as nutrition, atmosphere, pH, and redox potential (Marsh and Devine, 2011). At different sites within the oral cavity at which the biofilm is attached, these conditions can vary; in addition, environmental alterations occur according to health and any disease condition. Due to such variation in the environmental conditions, the microorganisms also change by changing their genome expression, either to downregulate or upregulate the expression to accommodate these changes (Marsh and Devine, 2011).

The chronological changes that occur in oral cavity biologies, such as tooth eruption, either primary or permanent, saliva flow rate, and changes in the host immune system, can lead to alterations in the structures of these communities as well as the metabolic action of the contained organisms (Marsh *et al.*, 2015). Additionally, smoking and medicine uptake as a requirement of individual lifestyle or need can also be included as a causal factor in the alteration of the oral biofilm microbial communities (Delima *et al.*, 2010; Costello *et al.*, 2012; Arrieta *et al.*, 2014). The components of an individual's diet also affect oral microflora, and there is a profound effect in the case of frequent intake of sugar, even though the ordinary daily diet in general has relatively little influence on the oral microflora (Marsh *et al.*, 2015).

Using next generation sequencing, several studies have shown that a number of genera are present in the oral cavities of almost everyone: *Streptococcus*, *Veillonella*, *Granulicatella*, *Neisseria*, *Haemophilus*, *Corynebacterium*, *Rothia*, *Actinomyces*, *Prevotella*, *Capnocytophaga*, *Porphyromonas* and *Fusobacterium* (Keijser *et al.*, 2008; Zaura *et al.*, 2009; Maddi and Scannapieco, 2013; Sturgeon *et al.*, 2013). Most studies of the oral microflora have concentrated on the dental biofilms accumulated on tooth surfaces. Variations in the environmental characteristics of the different dental surfaces where the oral microorganisms are attached lead to greatly diverse microbial compositions (Wright *et al.*, 2013). The resident microorganisms in dental biofilms depend on complex host molecules,

like proteins and glycoproteins, for their nutritional demands. Catabolism of these molecules occurs sequentially by the different bacterial species of the oral bacterial community (Wright *et al.*, 2013).

On the tooth surface, supragingival dental plaque is composed of mostly gram-positive bacteria (such as *Streptococcus* spp.), which are facultatively anaerobic. Saliva is a key source of nutrients (Marsh *et al.*, 2015), and the colonised bacteria are also able to metabolise host and dietary sugars. By contrast, mature subgingival dental plaque is occupied mostly by gram-negative species that are obligatory anaerobic. The biofilm community of this site gains nutrients primarily from gingival crevicular fluid, and the proteolytic style of metabolism is performed by the colonised bacterial species (Marsh *et al.*, 2015).

Thus, the structure and metabolic activity of colonised bacterial species at a particular site are affected by, and impact upon, the surrounding oral environment in a dynamic relationship. The oral microbiota composition can stay stable over time due to this dynamic relation. This stable biofilm composition can be altered when the local environment and individual lifestyle deviate, as mentioned previously, tending the biofilms toward disease (Marsh *et al.*, 2014; Marsh *et al.*, 2015). During progression from health to disease, the balance of bacterial diversity changes from a stable ‘microbial homeostasis’ to what is known as dysbiosis (Gross *et al.*, 2010).

### ***1.3.2 Bacterial interactions in oral biofilms***

Dental plaque, as an example of an oral biofilm, starts to develop by adhesion between specific bacterial species and the acquired enamel pellicle on a tooth surface (Kolenbrander, 2011). This early attachment is facilitated by specific and non-specific interaction with adsorbed organic conditioned biofilm components, due to the physicochemical interaction; this results in bacterial microcolonies because of further co-adhesion and growth (Rickard *et al.*, 2003). The physical, chemical, and metabolic interactions that occur among different oral bacterial species are essential to preserve their relationship inside the biofilm community, and are essential processes for driving the development of dental biofilms (Kolenbrander *et al.*, 2010; Jenkinson, 2011; Wright *et al.*, 2013). Further bacterial growth within the biofilm can occur by intergeneric coaggregation between genetically dissimilar bacterial partners, and this leads to close interaction of these partner cells, which in turn can help them to exchange nutrients or signalling molecules with one another (Kolenbrander *et al.*, 1990; Peters *et al.*, 2012).

Bacterial cells continue to accumulate for further biofilm development, and communicate with each other via the chemical interaction process of signalling diffusion named 'quorum sensing' (QS). Cell-cell communication through QS is mediated by 'QS molecules', small secreted molecules that are produced, secreted, and recognised by the bacterial community of the biofilm. Gram-negative bacteria, for example, can produce specific QS molecules which are acylated homoserine lactones (HSL), but these molecules have not been detected in oral biofilms (Jarosz *et al.*, 2011). However, certain gram-positive bacteria can secrete small signalling peptides for species-specific QS, and there are other QS molecules that can be more generic and are produced by both gram-negative and gram-positive bacteria, such as autoinducer-2 (AI-2). This is a complex molecule (actually six different molecules that form an equilibrium, but the main one is (S)-4,5-Dihydroxy-2,3-pentandione, usually abbreviated to DPD) that is the product of the bacterial *luxS* gene (Loo *et al.*, 2000; Cvitkovitch *et al.*, 2003; Krom *et al.*, 2014). All of these molecules of QS and whichever system produced them are important for interbacterial signalling inside the biofilm community (Jarosz *et al.*, 2011).

The microbial configuration and formation of biofilm within the oral cavity is affected by AI-2 mediated QS between bacteria (Wright *et al.*, 2013). Adhesion of certain bacterial species in the oral biofilm can be reduced by inhibition of AI-2 signalling (Jang *et al.*, 2013).

Metabolic interactions are also thought to be critical for oral biofilm development. Direct metabolic interaction involves metabolite production by one bacterial species and ingestion by another species, for example, the metabolic interaction between the *Streptococci* and *Veillonella* occurs when a carbon source is available (Gross *et al.*, 2012). Harmonised regulation in different species gene transfer is another form of interspecies interaction, which is also essential for the three-dimensional distribution of the oral biofilm bacterial community (Liu *et al.*, 2016). Different phenotypes, such as the regulation of metabolic level, antibacterial compounds resistance, or biofilm formation ability, have all been found to be provided by the horizontal transfer of genes. In addition, certain defence characteristics within oral biofilm can develop as a result of this bacterial interaction, such as improving the resistance of the biofilm community against antibiotics, and the protection of biofilm from other traumatic stress, including host immune responses (Liu *et al.*, 2016).

### ***1.3.3 Early coloniser bacterial species in dental biofilm***

Certain microorganisms in the oral cavity such as streptococci are well-adapted to colonise clean tooth surfaces and these are known as early or 'pioneer' colonisers. Initially, the enamel of the tooth surface is coated by the acquisition of salivary pellicles. Different receptors

required for the attachment of the primary coloniser of dental plaque are found within these pellicles, such as proline-rich proteins (PRPs), phosphate-rich proteins (statherin), and alpha-amylase (Mancl *et al.*, 2013). When colonising the enamel surface, early coloniser bacterial species attach to salivary pellicle (Scannapieco, 1994), and their individual source of nutrition is achieved by metabolising the salivary component (Palmer *et al.*, 2001; Zhou *et al.*, 2016).

Early colonisers are capable of coaggregating with other bacterial species and with saliva pellicles components (Palmer *et al.*, 2003; Yoshida *et al.*, 2005). Thus, they facilitate the colonisation of other bacteria, such as the species of *Actinomyces*, *Veillonella* and *Haemophilus* (Donlan and Costerton, 2002). The biofilm grows and increases in complexity, as other later colonisers attach (Flemming and Wingender, 2010). The early colonisers are critical for the whole process of biofilm development, and potentially impact the health or disease status of the host (Kreth *et al.*, 2009a; Whitmore and Lamont, 2011). More mature biofilms contain extracellular matrix substances that stabilise the biofilm and form a supporting skeleton for further division and growth of bacterial cells, and the development of a multispecies, three dimensional biofilm community (Hoiby *et al.*, 2011; Mancl *et al.*, 2013).

#### ***1.3.4 Cariogenic bacterial species in dental biofilm***

Dental caries is considered to be an unusual disease. In order to occur, what is required is both the cariogenic bacterial species and the presence of fermentable dietary carbohydrates, transformed to lactic acid by the digestive activity of these cariogenic bacteria. Consequently, carious lesions result due to the demineralisation of tooth surfaces by the lactic acid produced. Therefore, ideally, any bacterial species with the ability to convert sugar to lactic acid is considered to be potentially cariogenic (Scannapieco, 2013). Different cariogenic bacterial species exist in the oral microflora, living within the microbial community without being the cause of the development of dental caries, as long as a symbiotic relationship is predominant in the microbial community (Kilian *et al.*, 2016). A shift in the existence of these cariogenic bacterial species within the dental biofilm accumulating on tooth surfaces causes dysbiosis in the biofilm microbial community, and dental caries can develop as a result (Scannapieco, 2013).

Studying different bacterial samples obtained from caries-free individuals and those with established carious lesions has revealed the presence of polymicrobial infection in 100% of the cariogenic lesions; in contrast, the healthy microbial population dominated by gram-

positive cocci and rods had shifted to be dominated by gram-positive anaerobic bacilli (Peters *et al.*, 2012; Scannapieco, 2013).

Various techniques have been used to investigate the multibacterial population of carious lesions. The shifting of the population has been noticed within the cariogenic site using denaturing gradient gel electrophoresis (DGGE) assessment. Additionally, a comparison of patients with active carious sites and healthy controls has shown an elevation in *S. mutans* colonisation associated within carious sites (Li *et al.*, 2005). Other studies have shown that *S. mutans* is rarely more than a tiny proportion of the total microbiota, even in disease (Aas *et al.*, 2008; Gross *et al.*, 2010; Gross *et al.*, 2012).

Bacterial species have been cultured from children with early childhood carious lesions as well as from children free of caries, and these were profiled using DGGE. In this study, cariogenic characteristics were associated with *Fusobacterium* and *Neisseria*, while *Bacteroidetes*, *Treponema*, *Prevotella*, and *Corynebacterium* were associated with health (Li *et al.*, 2007). Extensive screening of oral microbiota isolated from the intact teeth of healthy children and from children with carious teeth by 16S rRNA sequencing has identified differences in specific microorganisms between healthy sites or carious lesions. In a healthy condition, *S. sanguinis* significantly represented the highest proportion of the total population. On the other hand *Actinomyces gerencseriae*, *Bifidobacterium*, *S. mutans*, *Veillonella*, *Streptococcus salivarius*, *Scardovia wiggsiae*, *Streptococcus constellatus*, *Streptococcus parasanguinis*, and *Lactobacillus fermentum* were associated with the establishment of dental caries (Becker *et al.*, 2002; Tanner *et al.*, 2011b; Peters *et al.*, 2012).

From those screened species linked to a carious condition, *Veillonella* has the facility to metabolise lactate and succinate, and thus are probably simply benefitting from the carious environment rather than contributing to the disease process. In older people, 16S rRNA sequencing has been used to investigate differences in the microbial populations in the dental plaque of healthy individuals and individuals with root surface caries. Higher quantities of *F. nucleatum*, *Leptotrichia*, *Selenomonas noxia*, *Streptococcus cristatus*, and *Kingella oralis* bacteria were recorded in healthy people. In contrast, *Actinomyces*, *Lactobacillus*, *S. mutans*, *Enterococcus faecalis*, *Atopobium*, *Pseudoramibacter*, and *Propionibacterium* bacteria increased in people with carious root conditions (Preza *et al.*, 2008; Peters *et al.*, 2012). Using different culture-dependent techniques, such as microscopic examination, cultural analysis, and enzymatic assays, showed clearly the association of *S. mutans* with development of dental

caries, and to understand more about the complexity of the cariogenic biofilm community, different independent culture techniques, such as 16S rRNA gene sequencing, next generation sequencing (NGS) methods, and metagenomics, have been used (Peters *et al.*, 2012; Kilian *et al.*, 2016).

### **1.3.5 *Streptococcus mutans* in dental biofilm**

*Streptococcus mutans* are gram-positive facultatively anaerobic bacteria that exist in the oral cavity on tooth surfaces (Zero *et al.*, 2009). Oral disease development like dental caries is linked with recognising *S. mutans* as one of the main causative pathogens (Mattos-Graner *et al.*, 2014). It is a strong acidogenic microorganism (Takahashi and Nyvad, 2008). Initially, *S. mutans* was isolated from carious human teeth by (Clarke, 1924). The term ‘*mutans*’ originated from observations that the cell morphology changed from cocci to elongated rod-shaped cells as the environment became more acidic. Since the creation of an acidic environment in the oral cavity is a key aetiological factor in dental caries, various studies were initiated to screen the oral microflora for bacterial species which contributed to acidity. *S. mutans* was rediscovered as a strongly acidogenic species in studies around the late 1950s and early 1960s, and then such studies started to assess the potential of *S. mutans* to cause caries (Hillman *et al.*, 2000; Banas, 2004).

Though many different bacterial species are associated with the development of dental caries, the presence of *S. mutans* was significant in samples from carious lesions taken at different stages of ECC dental development (Tanner *et al.*, 2011b). *S. mutans* has a number of potential virulence factors thought to be involved in caries: (i) extensive acid production from dissolution of the tooth enamel because of the *S. mutans* acidogenicity; (ii) the ability to grow in an aciduric environment at low pH, as well as challenging other bacterial species in the biofilm community; and (iii) extensive production of exopolysaccharides, including glucans and fructans, from sucrose (Takahashi and Nyvad, 2011; Koo *et al.*, 2013). Thus, *S. mutans* is particularly well adapted to benefit from low pH environments in comparison to other species in dental plaque (Falsetta *et al.*, 2012; Lemos *et al.*, 2013).

### **1.3.6 The role of exopolysaccharides (EPS) in later coloniser biofilm**

Biofilms consist of bacterial cells embedded in a matrix of extracellular polymers, and this matrix is critical for the overall function of the biofilm (Watnick and Kolter, 2000; Branda *et al.*, 2005). The extracellular matrix is primarily a microbial cell-derived constituent of biofilm. The matrix forms a three-dimensional (3D) structure, within which there are pockets

of localised microenvironments (Koo *et al.*, 2013). The matrix is difficult to remove, and is thought to protect bacteria from antimicrobials, as well as to provide reservoirs for pathogens and toxins (Koo *et al.*, 2013). In some situations, up to 40% of supragingival dental plaque dry weight is composed of polysaccharides, depending on plaque age and type of consumed carbohydrate (Leme *et al.*, 2006).

The process of biofilm assembly and matrix production is thought to occur sequentially as follows: (i) initial microbial colonisation and metabolic activity leads to the production of an initial polymeric matrix; (ii) bacterial cells become enmeshed in the EPS matrix, and further expansion of the 3D matrix occurs as a result of continuous *in situ* production of the EPS; (iii) the EPS matrix further develops and becomes more heterogenous as microcolonies of bacterial cells form (Xiao *et al.*, 2012). In a cariogenic dental biofilm, EPS production is considered to be an essential virulence determinant in dental caries pathogenesis (Bowen and Koo, 2011). *S. mutans* is able to use a range of glucan binding proteins Gbps (GbpA, GbpB and GbpC) in order to bind to the EPS matrix (Lynch *et al.*, 2007; Lynch *et al.*, 2013). The major EPS components in cariogenic biofilms, glucans and fructans, are formed by the action of *S. mutans* exoenzymes, known as glucosyl- or fructosyl-transferases (GTFs or FTF), which are present in the pellicle and on microbial surfaces (including non-mutans) of the early coloniser bacterial species (Koo *et al.*, 2013). Some of these exoenzymes can also be produced by pioneer species such as *S. gordonii*, which can make GtfG (Huang *et al.*, 2014; Ricker *et al.*, 2014), and *A. oris*, which can produce FTF (Bergeron and Burne, 2001; Yamane *et al.*, 2013).

The enzymes couple the degradation of sucrose to the formation of polymeric glucan or fructan chains. Most of the exopolysaccharides retained in dental plaque biofilms are insoluble and structurally complex glucans (Kopec *et al.*, 1997; Bowen and Koo, 2011). Some GTF enzymes secreted by *S. mutans* bind avidly to the pellicle formed on the tooth surface and to bacterial surfaces. They have the ability to form glucans *in situ* within minutes when they are exposed to sucrose consumed by an individual (Klein *et al.*, 2009; Habimana *et al.*, 2014). GTF are adsorbed on the surface of non-streptococcal oral bacteria (e.g., *Actinomyces* and *Veillonella* spp.) and can enable these species to synthesise glucans, even though they do not themselves produce GTF enzymes (McCabe and Donkersloot, 1977). Genes encoding GTFs in *S. mutans* are upregulated in response to pH and carbohydrate availability, indicating that environmental sensing is a key factor for the production of the EPS matrix (Li and Burne, 2001).

*S. mutans* can metabolise the sucrose and hydrolyse it via excreted protein from their exoenzymes Gtfs into monosaccharides fructose and glucose; at the same time, the glucose can be polymerised by these enzymes to form glucans (Banas and Vickerman, 2003). Two main glucans, which *S. mutans* has the ability to produce, are mutan, which is an insoluble glucan with  $\alpha$ -1,3-glucan-binding, and dextran, which is soluble glucan with  $\alpha$ -1,6-glucan-binding. Both of these glucans are very important for the involvement of *S. mutans* in developing the biofilm community. When there is a deficiency in food containing saccharides, dextran can be useful as a further metabolism substrate. In contrast, mutan has a sticky nature and can improve *S. mutans* adhesion and participate in growing the biofilm mass. Additionally, *S. mutans* can, rarely, produce a soluble fructan named inulin. This fructan is a derivative of fructose metabolism and can act as dextran acts in being a store of extracellular metabolic substrate (Biswas and Biswas, 2005; Takahashi and Nyvad, 2008).

### ***1.3.7 The role of extracellular DNA (eDNA) in biofilms***

Extracellular DNA (eDNA) is another major component of the dental biofilm matrix, in addition to EPS and protein substances (Rostami *et al.*, 2017). Of course, DNA is essential for all life forms since it is the genetic material of cells. However, the DNA derived from cells after they die and lyse is not necessarily lost. DNA is a relatively stable molecule, and in protected environments can sometimes survive intact for thousands of years (Hebsgaard *et al.*, 2005; Nicholls, 2005). The accumulated eDNA inside the environment can form a key source of nutrients like phosphate (Dell *et al.*, 2005).

By the mid-1950s, eDNA had been observed in four microorganisms: *Staphylococcus aureus*, *S. epidermidis*, *Alcaligenes faecalis*, and *Pseudomonas fluorescens*. The composition of produced eDNA was shown to be similar to intracellular DNA (Catlin and Cunningham, 1958). The detected eDNA was described as a viscous 'slime' that promoted pellicle formation in broth culture and the surrounding bacterial cells (Catlin and Cunningham, 1958). Double stranded viscous DNA of high molecular weight can provide structural support for biofilms. Due to its physical properties, this molecule is ideally suited to providing adhesive support and protection to microbial cells (Whitchurch *et al.*, 2002; Das *et al.*, 2010). It can also promote adhesion to hydrophobic substrata when bound to the surface of bacterial cells (Das *et al.*, 2011).

In different bacterial biofilms, including dental plaque, eDNA is considered a functional component of the matrix, and a wide range of studies have reported different roles of eDNA in bacterial biofilms. These include being a source of nutrients for live cells (Finkel and



Kolter, 2001; Dell *et al.*, 2005), a source of genetic information exchanged by the horizontal transfer of genetic material (Vlassov *et al.*, 2007), and induced biofilm resistance against antimicrobials (Mulcahy *et al.*, 2008). It can act as a scaffold to stabilise the biofilm matrix (Das *et al.*, 2011), as an adhesin (Vilain *et al.*, 2009), and for antimicrobial protection (Jones *et al.*, 2013). The eDNA appears to be an essential component of the extracellular matrix and biofilm organisation in many microorganisms (Vilain *et al.*, 2009; Shields, 2014). However, not all species require eDNA for biofilm formation and eDNA can even act as a barrier to microbial adhesion (Berne *et al.*, 2010).

Differences also exist between the capacity of different bacterial species to uptake free DNA and incorporate it into their genetic code. In this regard, a variety of mechanisms have been described relating to different species releasing DNA into the environment (Jakubovics *et al.*, 2013). Cell lysis appears to be the most common mechanism of DNA release, and this may be linked to quorum sensing (QS), autolysins, metabolites, or bacteriocins. Autolysins, for example, appear to play a major role in eDNA release in many Gram-positive bacterial species, since the disruption of genes linked to cell lysis leads to the production of bacterial biofilms containing reduced amounts of eDNA (Thomas *et al.*, 2008; Thomas *et al.*, 2009; Liu and Burne, 2011). Autolysis involves self-digestion of the cell wall by peptidoglycan hydrolases, and is a mechanism for programmed cell death in bacteria (Heilmann *et al.*, 1997; Blackman *et al.*, 1998; Smith *et al.*, 2000; Mercier *et al.*, 2002).

The development, dispersal, and persistence of biofilms has been shown to be affected by autolysis (Ahn and Burne, 2007; Bayles, 2007; Rice and Bayles, 2008). Although autolysis kills individual cells, it promotes the survival of the population during periods of stress by the removal of old or damaged cells from the biofilm community (Rice and Bayles, 2003). Additionally, autolysis releases eDNA that can promote intercellular adherence, and in turn stabilises biofilms (Qin *et al.*, 2007; Das *et al.*, 2010). Extracellular DNA can promote aggregation of bacterial cells in early biofilms, and facilitate their initial attachment to surfaces. The surface hydrophobicity of a bacterial cell and acid-based interactions increase due to the presence of eDNA on the cell surface (Das *et al.*, 2010; Das *et al.*, 2011). The hydrophobic nucleotides of eDNA are shielded (protected) inside the macromolecule, while the polar sugar-phosphate backbone is exposed, making eDNA essential hydrophilic. Both polar and non-polar molecules are contained in the bacterial cell wall, and the hydrophobicity is increased as a result of interactions between the cell wall and eDNA. Here, the eDNA interacts with the polar sites of the bacterial cell wall, such as peptidoglycan structures,

leaving the hydrophobic sites free. Aggregation of hydrophobic bacteria occurs with hydrophobic surfaces as well as with each other, and binding to hydrophilic surfaces has been shown to increase with the presence of eDNA (Das *et al.*, 2010).

Extracellular DNA interacts with other biofilm matrix polymers, including EPS, and possibly with proteins (Rocco *et al.*, 2017), thus facilitating biofilm formation by enhancing cell to surface and cell to cell interactions, in addition to causing the structural integrity and stability of biofilms (Hu *et al.*, 2012; Jennings *et al.*, 2015). The cross-link between EPS and eDNA in *S. mutans* biofilm, for example, can enhance the adhesion of *S. mutans* cells in biofilm, as well the strength of the biofilm matrix and surface aggregation. Such incorporation of eDNA during the development of the biofilm matrix by binding to both bacterial cells and EPS can play an important role in forming a reliable biofilm matrix (Klein *et al.*, 2010). Extracellular DNA is also important in the natural exchange of genetic information in streptococci and other bacteria. When there is coordination between endogenous DNA, exogenous DNA, and cell lysis via the *S. mutans* competence system, heterogeneity in the clonal population occurs, and *S. mutans* are closely packed with the other bacterial species existing within the biofilm community (Narisawa *et al.*, 2011).

It is possible that *S. mutans* may obtain transforming DNA from neighbouring species such as *S. gordonii* as a result of the production of bacteriocins that mediate the lysis of *S. gordonii* cells (Kreth *et al.*, 2005a). In *S. gordonii* monocultures, the production of eDNA depends on releasing hydrogen peroxide (H<sub>2</sub>O<sub>2</sub>). High levels of H<sub>2</sub>O<sub>2</sub> have been hypothesised to lead from eDNA release, possibly via the lysis of bacterial cells (Itzek *et al.*, 2011). Extracellular DNA in other *Streptococcus* species such as *S. mutans* can also be released from lysed cells in association with QS molecules such as competence-stimulating peptides (CSPs) (Petersen *et al.*, 2005; Perry *et al.*, 2009; Wenderska *et al.*, 2012). Thus, eDNA release can result from programmed cell death and lysis (Thomas *et al.*, 2009; Liu and Burne, 2011), but can also occur independently of cell lysis released/secreted in an active manner, by depending on exogenous H<sub>2</sub>O<sub>2</sub> generated pyruvate oxidase (Pox) under ambient oxygen control, as in *S. sanguinis* and *S. gordonii* release of DNA (Kreth *et al.*, 2008; Kreth *et al.*, 2009b).

*S. mutans* is an organism that colonises a dental biofilm, and possesses multiple mechanisms to attach the tooth surface (Crowley *et al.*, 1999; Bowen and Koo, 2011; Lemos *et al.*, 2013). Both EPS and eDNA are important components of the biofilm matrix (Xiao *et al.*, 2012; Rostami *et al.*, 2017). Surface and intercellular adhesion contribute to the interaction of highly

structured eDNA with the substratum, as well as close and distant biofilm bacterial cells. Further strengthening of the extracellular matrix scaffold occurs when eDNA and the adhesive glucan products of the *S. mutans* Gtfs enzymes interact with each other during the growth of dental biofilm in the presence of sucrose (Klein *et al.*, 2015). Inter- and intracellular interactions and biofilm accumulation are facilitated as a result of such a polymeric scaffold, in addition to increased resistance to mechanical stress which in turn provides greater stability for the established dental biofilm (Whitchurch *et al.*, 2002; Lappann *et al.*, 2010; Hu *et al.*, 2012).

#### **1.4 Models for Cariogenic Biofilms *In vivo* and *In vitro***

In order to investigate dental caries, multiple and different biofilm models have been developed (Salli and Ouwehand, 2015). These models have been used to investigate many questions about cariogenic biofilms, such as the different bacterial interactions that may occur in relation to which bacterial species grows within it (Blanc *et al.*, 2014), how their metabolic activity may be affected, and how to make them less harmful by testing another carbohydrate source like xylitol rather than sucrose (Bader *et al.*, 2013). In addition to the inhibition of antimicrobials, which affect the growth of pathogenic bacteria, new ways of influencing oral cavity pH-levels have been established, alongside how to improve enamel remineralisation. Developing new restoration material to minimise the possibility of secondary caries is one future approach for developing cariogenic biofilm models (Kutsch, 2014; Salli and Ouwehand, 2015).

##### **1.4.1 Cariogenic biofilms models *in vivo***

Several different *in vivo* and *in situ* models have been developed for caries study, such as clinical sample analysis (Dewhirst *et al.*, 2010). A rodent model of dental caries has been used to develop *in vivo* cariogenic biofilms. In this system, animal models of caries have been used to investigate: (i) the characteristics of dental caries as infectious disease (Fitzgerald and Keyes, 1963; Tanzer, 1979; Bowen *et al.*, 1988a; Bowen *et al.*, 1991); (ii) the expression of genes involved in the development of carious lesions and transmissibility (Yamashita *et al.*, 1993; Fozo *et al.*, 2007), and (iii) an investigation of the effects of host factors such as salivary proteins on the development of dental caries (Bowen *et al.*, 1988a; Bowen *et al.*, 1988b; Catalán *et al.*, 2011). Furthermore, cariostatic agents and their probable therapeutic effects have been examined with the aid of such *in vivo* cariogenic biofilm models (Koo *et al.*, 2005; Koo *et al.*, 2010a). A caries scoring system was developed for the rodent model of

caries and has been shown to be standardised, well established; it has also been tested thoroughly (Klein *et al.*, 2012). The rodent model of dental caries itself is well established and has been used extensively to advance understanding of complex pathophysiological aspects of dental caries disease by using cariogenic *Streptococci* (Fitzgerald and Keyes, 1963; Tanzer, 1979; Bowen *et al.*, 1988a; Bowen *et al.*, 1991). An approach to understand what is involved in the pathophysiology of dental caries in relation to the complexity of diet-pathogen-host interactions has also been investigated using the rodent model of dental caries (Klein *et al.*, 2012). A preventive approach to dental caries is also an additional new area that has been explored using this model (Koo *et al.*, 2010a). *In vivo* cariogenic biofilm models can be used to measure the viable content of the microbial population, and the gene expression of established cariogenic biofilms can provide an assessment of the infectious aspect of dental caries, and the virulence of *in vivo* developed biofilm can be evaluated as well (Klein *et al.*, 2012). However, although *in vivo* models are suitable for many applications, there are a number of limitations. For example, rodent teeth grow continually throughout life, unlike human teeth, and are a different shape from human teeth. In addition, the immune system of rodents is different from that of humans. Animal studies also raise potential ethical concerns (Blanc *et al.*, 2014). The use of *in vivo* mammalian models importantly takes into account animal welfare and, at the same time, considers authorised guidelines that involve evaluation of the scientific and medical benefits of the research (Xiao *et al.*, 2012). Therefore, *in vitro* systems have emerged that aim to replicate the conditions of the oral cavity, but simplify and standardise the biofilms so they can be studied more easily (Blanc *et al.*, 2014).

Another *in vivo* model that has been employed to develop dental biofilms is the individual intraoral fabricated acrylic stent. Many variants of this model have been used to establish different biofilms on artificial substrate surfaces rather than a natural tooth surface (García-Caballero *et al.*, 2013; Quintas *et al.*, 2015). The developed biofilms have been used to study different statuses of dental biofilms, such as the effect of demineralisation in relation to established cariogenic biofilms, or to develop mature dental biofilm in order to analyse and understand the characteristics of *in situ* biofilms (Prada-López *et al.*, 2016). Here, the bacterial samples are freshly isolated from healthy and diseased oral conditions and further assessment was processed to understand the different bacterial compositions of normal and diseased statuses, such as dental caries (Dewhirst *et al.*, 2010). The design of *in vivo* intraoral acrylic splints has continuously developed to become suitable for developing and collecting dental biofilms from different places inside the oral cavity, such as buccal, lingual, and palatal sites (Prada-López *et al.*, 2016). In addition, the design development involved changing the

acrylic splint devices by making them more comfortable and discreet rather than being bulky and aesthetically poor (García-Caballero *et al.*, 2013; Quintas *et al.*, 2015). In spite of the different developments in these models, there are still certain limitations with their use; for example, it is not possible to control the microbial population (Prada-López *et al.*, 2016), and adding different agents to challenge the biofilm cannot be done unless they are approved for use in humans. In addition, during the removal of the appliance disk, where the biofilm should have become established, there is the possibility of accidental sample loss before further analysis can take place (Prada-López *et al.*, 2016).

#### ***1.4.2 Cariogenic biofilms models in vitro***

In dental biofilm, depending on which bacteria are present and the prevalent external conditions, many different interactions and processes occur between the bacteria, leading to difficulties in interpretation of the findings (Blanc *et al.*, 2014). Therefore, it is important to develop *in vitro* model systems that are reproducible, and customised models are needed to investigate different questions related to biofilm formation, the caries development process, its prevention, how cariogenicity changes with different bacteria, and how diet or other compounds and materials affect cariogenicity (Steiner-Oliveira *et al.*, 2007; Klein *et al.*, 2012). Low cost, easy set-up, and flexibility for high throughput are advantages offered by *in vitro* models. Additionally, factors that impact biofilm biology such as variable nutrient gradients, bacterial metabolic products and gases, high cell densities, and extracellular matrix production or release, can all be replicated via these models (Coenye and Nelis, 2010). In spite of this, no single model system can be used for all investigations. The example different *in vitro* biofilm models shown in Figure 1. 5 can be roughly divided into two groups: (i) closed batch culture, and (ii) open continuous culture models, which can be further divided into artificial mouth models (AMM), and flow cells.

The Calgary Biofilm Device (CBD), shown in Figure 1. 5A, is an example of closed model for biofilm growth developed by Ceri *et al.* in 1999. This device is a multipurpose model system with a two-part reaction receptacle based on the 96-well plate system, with adapted lids containing 96 pins immersed in liquid, which provides the substrate for biofilm formation. The lid of 96 pins is sealed on the top and thus, when the pins are removed for biofilm investigation, the container remains closed and exposure to contamination is avoided (Ceri *et al.*, 1999). Mostly, this model has been used to test the susceptibility of the formed biofilm to antibiotics. Since the antibiotic sensitivity of biofilm bacteria is often different from planktonic cells, it is important to have a model for assessing the antimicrobial resistance of

biofilms. By using the CBD, comparing the positive control with the lowest concentration of the antimicrobial can aid in the assessment of the ‘minimum biofilm eradication concentration’ of the tested antimicrobial. Furthermore, scanning electronic microscopy (SEM) or CLSM can be employed to visualise the biofilm sample (Macià *et al.*, 2014). Thus, for the determination of Minimal Biofilm Inhibitory Concentration, Minimal Biofilm Eradication Concentration, and Biofilm Bactericidal Concentration for various antibiotics and antimicrobials, the CBD has been extensively used (Ceri *et al.*, 1999; Macià *et al.*, 2014).

Batch and continuous culture systems in general are employed for monoculture biofilms, biofilms involving defined groups of organisms (from two up to ten species), or ‘microcosm’ biofilms (where the saliva or plaque sample used as inoculum) (Steiner-Oliveira *et al.*, 2007; Salli and Ouwehand, 2015). In the batch biofilm models, the substrates for biofilm establishment are usually microplate wells, disc surfaces, slips or pins, or human or bovine enamel within the well (Coenye and Nelis, 2010). With such a closed system, as long as the nutrients are consumed and metabolic products accumulate, the environment inside the well is changed during use, unless the growth media are replaced (Coenye and Nelis, 2010). In this regard, they are different from the oral cavity where fluid continually flows over the biofilm, supplying fresh nutrients and removing waste (Guggenheim *et al.*, 2004). In some of these batch models, flow conditions can be generated and liquid shear force may be formed if, during establishment, the biofilm has been submersed in saline or other liquid (Guggenheim *et al.*, 2004). Nevertheless, it is possible to compare multiple test compounds or different environmental conditions simultaneously using batch models. These models are also reproducible and economical to use, as they only require small amounts of reagents (Coenye and Nelis, 2010). The effect of different substances on the mixed species biofilm formation process, such as plant extracts (Furiga *et al.*, 2014), chlorhexidine (Guggenheim and Meier, 2011), and xylitol (Giertsen *et al.*, 2011), has been investigated extensively using a 24-well polystyrene cell culture plate batch biofilm model with hydroxyapatite discs (HA discs) placed in the well, used as substrate for the establishment of the mixed species biofilm. This model has additionally been used to study the oral probiotics effect on the growth of biofilm (Martinen *et al.*, 2013), by developing methods to analyse the microbial population in the biofilm community (Álvarez *et al.*, 2013), as well as de- and remineralization in a biofilm with variable times of development (Guggenheim *et al.*, 2004; Arthur *et al.*, 2013).

As a continuous biofilm model, artificial mouth models (AMM) are one such biofilm model which can address this category. The AMM term is usually used to describe a system with a

continuous, open-surface fluid flow, which excludes closed-flow cells, and can be used to develop biofilm (Sissons, 1997; Shu *et al.*, 2000). In the AMM, the biofilm can be established on human or bovine sectioned teeth (Russell and Coulter, 1975; Hayati *et al.*, 2011; Mei *et al.*, 2013), or on resin-based composite (Ionescu *et al.*, 2012). Then, an intermittent or continuous flow of nutrients is pumped over the biofilm, mimicking the *in vivo* situation as closely as possible (Tang *et al.*, 2003). Oral conditions can be stimulated by AMM in terms of temperature, humidity, pH, nutrients, saliva flow rate, and sucrose supply. Differences between different AMMs still present due to the variability in biofilm formation time, nutrient media, and equipment used (Salli and Ouwehand, 2015). This biofilm model system is more complex in comparison to the batch system; however, it is more representative of conditions in the oral cavity and therefore well suited to study the bacterial interaction within biofilm and the compounds being tested, as well as the overall growth and structure of dental plaque. A drawback of the AMM is that it tends to be less reproducible than batch culture systems (Mei *et al.*, 2013).

Microfluidics flow cells systems, such as the Bioflux (Figure 1. 5B), are other *in vitro* systems commonly used to provide a relatively simple flowing environment to represent bacterial biofilms in situations resembling those inside the oral cavity. The bacterial colonisations are repeatedly exposed to an ideal fluid flow condition and shear stress (Kim *et al.*, 2012). The system is composed of a closed channel, where the bacterial suspension is inoculated and allowed to grow into a biofilm. One side of this channel is transparent and amenable to microscopy. Through the channel, the growth media is run without interruption and thus, following the bacterial inoculation, the cells within developed biofilm remain adherent and are supplied with fresh medium in a continuous manner, while the biological waste and unattached cells are removed (Nance *et al.*, 2013). Studies conducted to assess the short-term adhesion and colonisation of bacteria have often used the flow cell system. An advantage of this approach is that biofilms can be imaged non-destructively (Pamp *et al.*, 2009).

The Constant Depth Film Fermenter (CDFF; Figure 1. 5C) is a continuous biofilm model system that was developed to culture biofilms of constant thickness. Liquid is drip-fed into the system and biofilms are formed on recessed surfaces. A blade wipes over the surfaces, ensuring that biofilms are retained at a constant depth equal to the depth of the recess. The scraper also distributes the growth medium over the biofilms. Both aerobic and anaerobic situations can be selected as growth conditions within CDFF (McBain *et al.*, 2003; ten Cate, 2006). The CDFF is particularly well-suited to the studying of biofilm maturation,

antimicrobials' effect on biofilm formation, and the influence of substratum material on biofilm growth (Zaura *et al.*, 2011; Hope *et al.*, 2012).

The Modified Robbins Device (MRD; Figure 1. 5D) is a continuous flow biofilm model, where different bacterial species can be grown in different growth media, with the possibility of using different substrates for biofilm formation. Tubes of plastic or metal are designed to contain a number of individual plugs that can be inserted inside the tube, and are flush with the wall of the system. Culture media are sent in a continuous flow over the surface of the plug, and thus the bacterial inoculum inside MRD is nourished continuously during biofilm development. Each biofilm sample formed on the surface of the MRD plug can be removed later to sample separately (Coenye and Nelis, 2010). The collected biofilm can also be transferred to a different growth medium for further investigation, and, as with CDFF, tests such as the evaluation of the anti-biofilm activity of disinfectants can be achieved on MRD biofilms samples when they are out of the system. In addition, multiple investigation techniques, as well as different product assessments, can be processed at the same time (Coenye *et al.*, 2008). Estimation of the effect of different flow rates in relation to the maximum bacterial biofilm growth rates can be achieved successfully by using the MRD (Bagge *et al.*, 2001). More than one MRD can be assembled at the same time and run in parallel, enabling direct comparisons between different growth media or substratum types. Other advantages of MRD over *in vitro* static dental biofilms models are that, since it is an open system, the growth media used to develop the biofilm can be continually replaced, just as normally occurs within the oral cavity (Lebeaux *et al.*, 2013). The disadvantage that has been noticed with running MRD is that the same media flow over the first plug to the last one, which can cause variation in established biofilm among the plugs along the MRD (Bagge *et al.*, 2001). In addition, the system is relatively time-consuming and laborious to run.



A) CBD

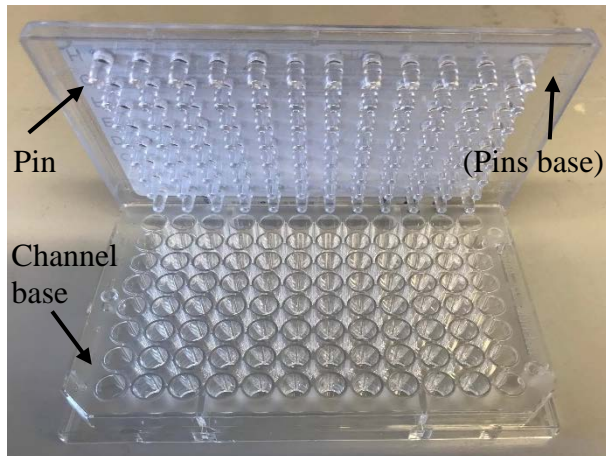

B) Bioflux microfluidics flow cells

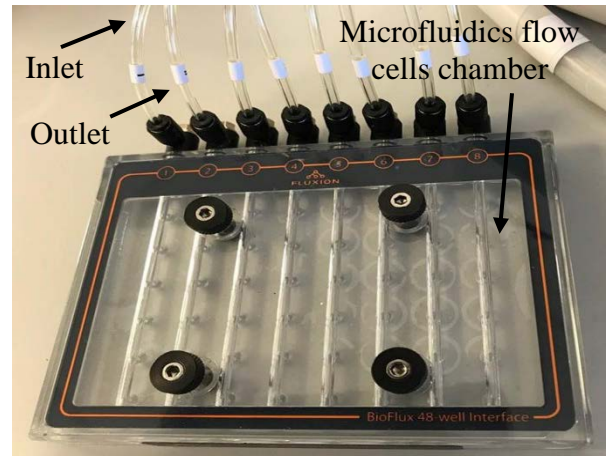

C) CDFF

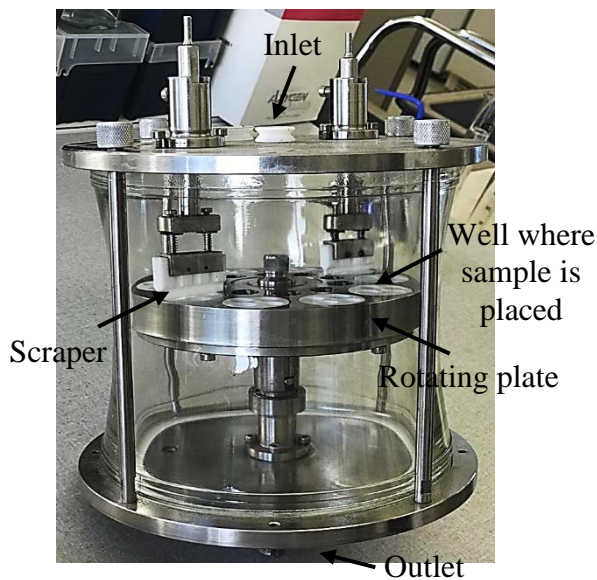

D) MRD

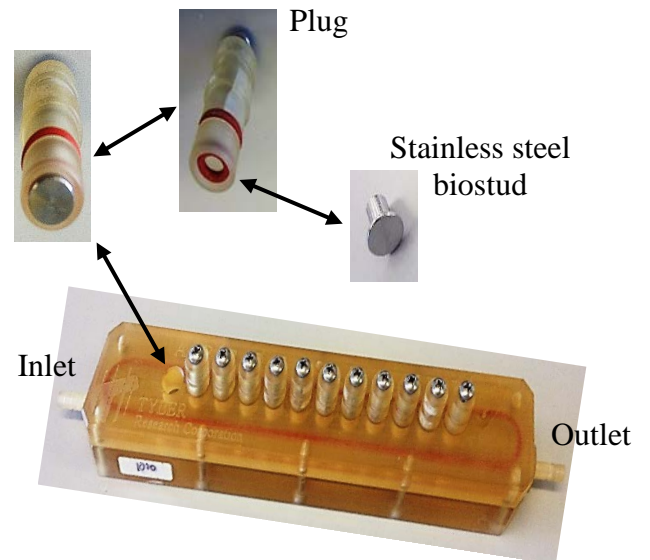

Figure 1. 5 Examples of different *in vitro* systems for growing biofilm. The Calgary Biofilm Device (A) is an example of a batch system. Biofilms are formed on the surface of the pegs. In the Bioflux system (B), biofilms develop inside microfluidic channels under liquid flow. The Constant Depth Film Fermenter (CDFF) (C), is another ‘open’ system where biofilms form on substrata placed in wells. A scraper maintains the biofilm at a constant depth by passing over the well during movement of the rotating plate. In the Modified Robbins Device (D), the stainless steel biostud is held by a plug, and placed upside down inside the device and flush against the channel. Biofilms are formed on the biostud surface under fluid flow. See text for more details.

## 1.5 Aims and Objectives

### ***In this study we aimed to:-***

- Develop a model to investigate the incorporation of *S. mutans* into preformed mixed-species biofilms, and use it to investigate factors involved in colonisation.

### ***In this study our objectives were:-***

- 1- Establish pioneer colonisers mixed species biofilm models, with and without 0.1% sucrose, using MRD, and quantify the numbers of bacterial cells within the biofilm models to investigate their reproducibility and stability.
- 2- Challenge the preformed mixed biofilms with different *S. mutans* strains (UA159 and GS5), evaluating their ability to integrate within the biofilms in relation to the presence or absence of sucrose, and comparing their colonisation within the preformed biofilms.
- 3- Characterise the structure of mixed-species biofilms using a range of imaging methods, including localising *S. mutans* cell by FISH.
- 4- Assess the impact of eDNA on *S. mutans* colonisation using a *S. gordonii ssnA* (deoxyribonuclease) knockout mutant.

## Chapter 2. Materials and Methods

### 2.1 Routine Culture of Microorganisms

Routine microbiological techniques were used to culture the different bacterial species within this study. Initially, bacteria were grown on agar plates; colonies were inoculated and grown in broth to provide bacterial stock. Parallel to these steps, the existence of contamination was checked by Gram stain and microscopic examination of the different bacterial cells' morphology.

#### 2.1.1 Bacterial strains and culture media

Table 2. 1 Bacterial strains used in this study.

Bacterial strains	Genotype	Source/ Reference
<i>Actinomyces oris</i> MG1	Wild type	J. Cisar, NIDCR, USA
<i>Streptococcus gordonii</i> DL1	Wild type	H. Jenkinson, Bristol University, UK
<i>Streptococcus gordonii</i> NU01	$\Delta$ <i>ssnA</i> , <i>erm</i> <sup>r</sup>	Nick Jakubovics
<i>Streptococcus mutans</i> UA159	Wild type	ATCC
<i>Streptococcus mutans</i> GS5	Wild type	Newcastle Dental Hospital
<i>Veillonellae parvula</i> PK1910	Wild type	Rob Palmer, USA
<i>Escherichia coli</i> TOP10	F- <i>mcrA</i> $\Delta$ ( <i>mrr</i> - <i>hsdRMS</i> - <i>mcrBC</i> ) $\Phi$ 80 <i>lacZ</i> $\Delta$ M15 $\Delta$ <i>lacX74</i> <i>recA1</i> <i>araD139</i> $\Delta$ ( <i>ara leu</i> ) 7697 <i>galU</i> <i>galK</i> <i>rpsL</i> ( <i>StrR</i> ) <i>endA1</i> <i>nupG</i>	Invitrogen

*A. oris* MG1, *S. gordonii* DL1, and *S. mutans* (UA159 and GS5) were routinely cultured in THYE medium containing 30 g/L Bacto™ Todd Hewitt Broth (Becton Dickinson and Co., MD., USA), 5 g/L Yeast Extract (Melford Laboratories Ltd., Suffolk, UK). *V. parvula* PK1910 was grown in broth prepared from 37 g/L Brain Heart Infusion (BHI) (Melford, UK), 5 g/L Yeast Extract, 2.5 g/L L-Glutamic Acid (Sigma, MO., USA), 14 ml Lactic Acid (Sigma, USA), adjusted to pH 7.5 using NaOH. THYE broth containing 2  $\mu$ g/ml erythromycin (Sigma, USA) was used to grow *S. gordonii* NU01  $\Delta$ *ssnA*. The *E. coli* strains used for cloning experiments were cultured in Luria Bertani (LB) broth (Melford, UK). Ampicillin (Sigma, USA) (100  $\mu$ g/ml) was included in LB medium when appropriate. Solidified media were

prepared by adding 15 g/L Bacto Agar (Melford, UK). All culture media were sterilised by autoclaving for 15 min at 121°C under 1,200 bar before use.

### **2.1.2 Glycerol stocks of bacteria**

Inocula of 20 µl from each of *A. oris* MG1, *S. gordonii* (DL1, *ssnA*), *V. parvula* PK1910, and *S. mutans* (UA159 and GS5) were cultured separately in 20 ml of suitable broth. Following anaerobic incubation (80% N<sub>2</sub>, 10% H<sub>2</sub>, 10% CO<sub>2</sub> [Bugbox Plus, Ruskinn, Baker Co., Bridgend, UK]) for 24 h at 37°C, the bacterial cells were harvested by centrifugation at 3,800 g for 10 min at 4°C (bench top centrifuge model 3K10, Sigma, UK). Pellets were resuspended in 2.5 ml of fresh medium diluted 1:1 with 50% (v/v) glycerol. Aliquots were stored at 80°C. Bacterial samples from prepared stocks were taken to make bacterial stocks in the mid-logarithmic phase of growth; 20 ml of an appropriate broth was inoculated with 10 µl bacteria, and incubated anaerobically for 24 h at 37°C. Cultures were diluted 20 fold in fresh medium, and initial Optical Density (OD) readings at 600 nm were measured using a spectrophotometer (Biochrom Libra S11, Biochrom Ltd., Cambridge, UK). Following the time zero reading, the cultures were re-incubated at 37°C and the OD 600 nm was measured regularly up to the mid-exponential phase (OD 600 nm: 0.6-0.8). Cells were collected by centrifugation, and stocks were prepared, as described previously, and stored -80°C as inocula for biofilm growth experiments.

### **2.1.3 Calculation of total viable counts (TVCs)**

Total viable counts (TVCs) were measured according to the method of Miles *et al.* (1938). Briefly, to measure TVCs, serial ten-fold dilutions of cultures were prepared. Triplicate 20 µl samples were spotted on agar plates, and incubated anaerobically for 24-48 h at 37°C. Colonies were counted in spots containing between 10-100 colonies, and TVCs were calculated.

## 2.2 Molecular Biology Methods

The flow diagram below summarises the methods used to generate the qPCR standard to quantify the bacterial cells in established biofilms.

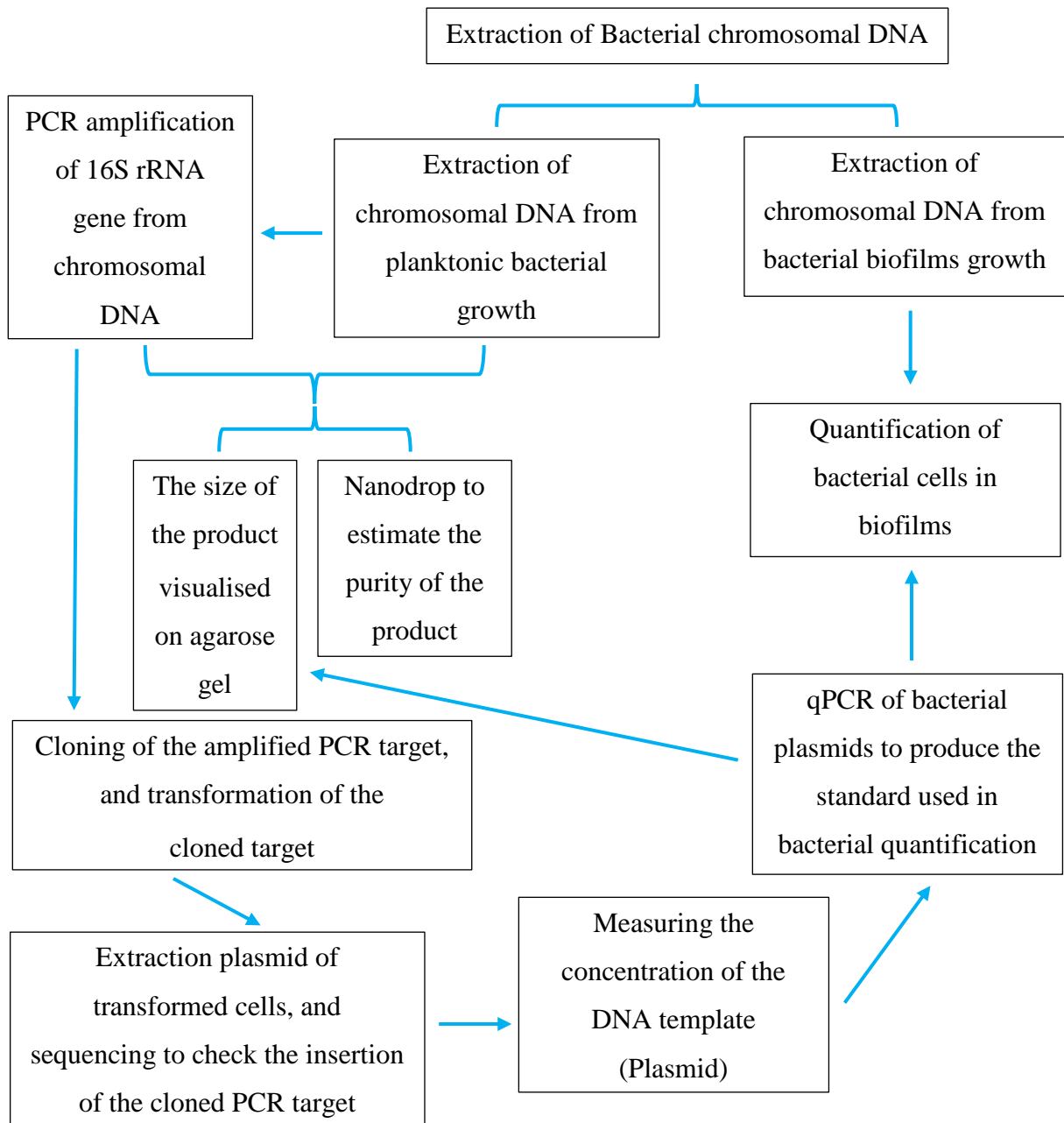

Figure 2. 1 Flow diagram demonstrating the molecular biological methods.

### 2.2.1 Extraction of chromosomal DNA

Chromosomal DNA was extracted from bacterial cells or from biofilms using the MasterPure DNA Purification kit (Epicentre, Wisconsin, USA) in accordance with the manufacturer's protocol. Bacterial cells from broth cultures were harvested by centrifugation at 3,800 g for 10 min at 4°C. Alternatively, biofilms scraped from biostuds surfaces (see Section 2.3.2) were also harvested by the same method for cDNA extraction. Pellets were resuspended in 150µl of

Spheroplasting Buffer [20 mM Tris-HCL (Melford, UK), 10 mM MgCl<sub>2</sub> (Sigma, UK), and 26% (w/v) Raffinose.5H<sub>2</sub>O (Sigma, UK)]. The mixture was transferred to an Eppendorf tube and 1.5 µl of lysozyme (250 µg/mL) and 5 µl mutanolysin (from the stock of 10,000 U/mL) were added, and incubated in a water bath at 37°C for 30 min. The MasterPure kit protocol was then followed, 150 µl of 2X T&C lysis solution were added. The samples were placed on ice and 1 µl of Proteinase K (50 µg/µl) was added. Samples were incubated at 65°C for 30 min, with short vortexing every 5 min. The mixture was cooled at 37°C for 10 min, 1 µl of RNase A (5 µg/µl) was added, and incubated at 37°C for 30 min. Samples were placed on ice for 5 min, and DNA was extracted in accordance with the manufacturer's instructions. Precipitated DNA was resuspended in 25 µl of TE buffer [10 mM Tris-HCL (Melford, UK), 1 mM EDTA (Sigma, UK), pH 8.0], and stored at -20°C for further analysis.

### ***2.2.2 Polymerase chain reaction (PCR)***

For amplification of the 16S rRNA gene of *V. parvula*, a PCR Master mix of total volume 12.5 µl was prepared by combining 1.25 µl of primer 0063F, 1.25 µl of primer 1387R, (Table 2. 2), 6.25 µl of MyTaq Enzyme, 2.75 µl of sterilised distilled water, and 1 µl of either DNA template or sterilised distilled water. The PCR was run on a PTC-200 Peltier Thermal Cycler (BIO-RAD, California, USA) using cycling conditions of: initial denaturation at 95°C for 1 min; denaturation at 95°C for 15 sec; annealing at 55°C for 15 sec; elongation at 72°C for 30 sec; repeat from second step (denaturation step) for 34 cycles; final elongation at 72°C for 5 min; followed by holding at 4°C. The PCR products were purified using the QIAquick PCR purification kit (QIAGEN GmbH, Hilden, Germany) following the manufacturer's protocol. Purified PCR products were analysed by agarose gel electrophoresis, and stored at -20°C.

Table 2. 2 PCR primers and qPCR primers and probes used in this study.

Bacterial species	PCR Primers	5' -3' Sequence	Target region (gene)	Source/ Reference
Universal	0063F	CAGGCCTAACACATGCAAGTC	16S rRNA	(Marchesi <i>et al.</i> , 1998)
	1387R	GGGCGGTGTGTACAAGGC	16S rRNA	(Marchesi <i>et al.</i> , 1998)
Bacterial species	qPCR Primers and Probes	5' -3' Sequence	Target region (gene)	Source/ Reference
<i>A. oris</i> MG1	hktE F	F 5'-CCATCGAGAAGGGCCAGTAC-3'	<i>hktE</i>	(Jakubovics, unpublished data)
	hktE R	R 5'-CCACATCTTCGTCAGGTCGAA-3'		
	hktE P	P 5'-6FAM-CATGTACGTCCAAACCA-TAMRA-3'		
<i>S. gordonii</i> DL1	hsdR F	F 5'-GGTGTTGTTTGACCCGTTTCAG-3'	<i>hsdR</i>	(Suzuki <i>et al.</i> , 2005)
	hsdR R	R 5'-AGTCCATCCCACGAGCACAG-3'		
	hsdR P	P 5'-6FAM-ACCTTGACCCGCTCATTACCAGCTAGTATG-TAMRA-3'		
<i>V. parvula</i> PK1910	16S rRNA F	F 5'-CTACAATGGGAGTTAATAGACGGAAG-3'	16S rRNA	(Ciric <i>et al.</i> , 2010)
	16S rRNA R	R 5'-CAGCCTACGATCCGAACTGAG-3'		
	16S rRNA P	P 5'-HEX-AGCAAACCCGAGAAACACT-IABK-3'		
<i>S. mutans</i> UA159	gtfB F	F 5'-GCCTACAGCTCAGAGATGCTATTCT-3'	<i>gtfB</i>	(Yoshida <i>et al.</i> , 2003)
	gtfB R	R 5'-GCCATACACCACTCATGAATTGA-3'		
	gtfB P	P 5'-6FAM-TGGAAATGACGGTCGCCGTTATGAA-TAMRA-3'		

### **2.2.3 Agarose gel electrophoresis**

Agarose gels containing 0.8% - 3% agarose, as required, were prepared by adding agarose (Melford, UK) to 55 ml of TAE buffer (40 mM Tris/acetate, 1 mM EDTA, pH 8.0), and were heated in a microwave (Sharp R-206, Sharp Co., Wrexham, UK) until dissolved. The mixture was cooled and 5 µl of GelRed Nucleic Acid Gel Stain 10.000X in water (Biotium, Cambridge, UK) were added prior to pouring the gels. Samples were mixed with 5x DNA loading buffer (Bioline Ltd., London, UK) in the ratio of 1:5, and then loaded onto the gel. HyperLadder (Bioline, UK) 1kb plus (250-12.007 bp), HyperLadder IV (100-1013 bp), and HyperLadder V (25-500 bp) were used as references for product size, as appropriate. Gels were run using a Bio-Rad Power Pac 300 (BIO-RAD, USA) for approximately 120 min at 90 v and visualised on a G:Box Transilluminator (Syngene, Cambridge, UK).

### **2.2.4 Nanodrop spectrophotometry**

Concentrations of nucleic acids were measured using a NanoDrop ND-1000 spectrophotometer (Thermo Scientific, UK). Sample purity was estimated according to absorbance ratios at 260/280 nm, and 260/230 nm. Ratios of 260/280 between 1.8-2.0 indicated high quality samples. All extractions were within this range.

### **2.2.5 Cloning in the PCR2.1-TOPO vector**

The PCR amplified target of *V. parvula* PK1910 was cloned into the PCR2.1-TOPO vector using TOPO cloning kit (Invitrogen, USA), and following the manufacturer's protocol. A ratio of 1:1 vector:insert was used, and pUC19 transformations were always included as a positive control. The transformation of *E.coli* TOP10 competent cells was carried out according to kit instructions. Following transformation, cells were plated on the surface of LB/Ampicillin (100 µg/ml) agar, to which had been added 40 µl from a stock of 40 mg/ml X-Gal (5-bromo-4-chloro-3-indolyl-B-D-galactoside), and 20 µl of freshly prepared Super Optimal broth with Catabolite repression (S.O.C) medium (Invitrogen). Plates were incubated aerobically at 37°C for 24 h for blue/white screening. The appearance of white colonies indicated successful ligation, while blue colonies indicated the absence of an insert in the vector. Samples of white colonies were subcultured in LB/Ampicillin agar plate, and incubated aerobically at 37°C for 24 h. This step was repeated at least three times to ensure the purity of the transformed cells' culture. Glycerol stocks of purified transformed cells were prepared as described in Section 2.1.2, and stored at -80°C as inocula for plasmid extraction. Samples of 10 µl from the pure subcultured white colonies were taken from prepared stock and recultured in 5 ml of LB broth with ampicillin, and incubated in a shaker incubator



(Orbital Shaker, Jencons, UK) at 250 rpm, 37°C for 16 h prior to plasmid extraction. Amplified PCR targets of *A. oris* MG1, *S. gordonii* DL1, and *S. mutans* UA159 had already been cloned into PCR2.1-TOPO vectors from previous studies.

### **2.2.6 Plasmid extraction and sequencing**

Plasmids were extracted from *E. coli* using the Isolate II Plasmid Mini Kit (Biolone, UK). Broth cultures (see Section 2.2.5) were centrifuged at 3,800 g for 10 min at 4°C, and the supernatant was discarded. The plasmids were extracted from the pellet following the kit manufacturer's instructions, detected by agarose gel electrophoresis, and stored at -20°C. The extracted plasmid samples were sent for sequencing, by Eurofins Genomics, UK. According to the sequencing instruction, two separate mixtures were prepared. Samples contained 15 µl of plasmid, but one was mixed with 2 µl of F primer (M13-20), and the other with 2 µl of R primer (M13). The software MEGA6 (Molecular Evolutionary Genetics Analysis, MEGA software, UK) was used to align sequences to ensure that the plasmids had the appropriate inserts.

### **2.2.7 Measurement of DNA concentration by PicoGreen**

For accurate determination of the DNA concentration, double stranded DNA was measured using the Quant-it™ PicoGreen dsDNA kit, (Invitrogen, USA), in accordance with the manufacturer's instructions. Standard λ DNA (2 µg/ml) was diluted in TE buffer (10 mM Tris-HCL, 1 mM EDTA, pH 7.5) to a range of 200 ng/ml to 0 ng/ml. Samples were diluted 1:20 in TE buffer. The PicoGreen reagent was also diluted 200-fold in TE buffer. In black 96 well plate, triplicate wells with 100 µl of either standard λ DNA, or DNA templates, were placed. An equal volume of 100 µl from prepared PicoGreen was added to both the standard and DNA template wells to obtain a total volume of 200 µl in each well. Fluorescence was measured in a Synergy HT microplate reader (BioTek, Bedfordshire, UK) using excitation at 485 nm and emission at 528 nm. The resulting standard curve derived from the λ DNA was used to calculate the unknown concentration of the DNA template. Triplicate samples were used for each analysis and three independent experiments were performed.

### **2.2.8 Quantitative PCR**

For quantification of bacterial cells, a standard curve was produced from a dilution series of plasmid DNA. Each qPCR reaction contained 2.5 µl of primers and TaqMan probe (Table 2.2) in concentration of 1:40 from main stock, in mixture ratio of 2:1 (F and R 1 µl each, and

0.5 µl probe), 6.25 µl of MyTaq Enzyme (Bioline, UK), 2.75 µl of sterilised distilled water, and 1 µl of either DNA template or sterilised distilled water in a total volume of 12.5 µl. The qPCR reaction was run in a DNA Engine Opticon 2 (BioRad, USA). The plate setup and cycling conditions were set using Opticon Monitor software (Bio-Rad Laboratories Inc., UK). Triplicate samples were used for each analysis. The qPCR reactions for the quantification of the *S. gordonii*, *S. mutans*, and *V. parvula* were performed with a cycling programme of: 95°C for 10 min, 95°C for 15 s, 60°C for 1 min, Plate read, and then the cycle from step 2 for 39 cycles. This was followed by holding at 4°C. An additional step of 50°C for 30 s was added after the second step (95°C, 15 min) when the qPCR was run for the quantification of *A. oris*.

## **2.3 Biofilm Models**

### ***2.3.1 Static biofilm model***

Static monospecies biofilms were established from each of *A. oris* MG1, *S. gordonii* DL1, and *V. parvula* PK1910. Sterile glass coverslips were placed in 12 well plates, and 2 ml of appropriate medium with and without 0.1% sucrose were added. Inoculum of 10 µl for each species was taken from prepared stocks in the mid-logarithmic phase of growth (see Section 2.1.2), subcultured into the media, and incubated anaerobically for 24 h at 37°C. The developed biofilms were collected and prepared for SEM examination (see Section 2.6.1).

### ***2.3.2 Biofilm model using the Modified Robbins Device (MRD)***

The MRD (Tyler Research Co., Alberta, Canada) was used for single and mixed species biofilms with and without 0.1% sucrose. All experiments were run three times independently for each developed biofilm. The key steps in setting up the MRD were started with the collection of natural saliva and its preparation, in addition to the preparation of the studs with tooth section in readiness for further MRD running and biofilm modelling. These steps are described in the following subsections.

#### ***Natural saliva collection***

Natural saliva was collected in accordance with a standard method (ethical approval from the University Research Ethics Committee No. 1083). The saliva stocks were prepared using a previously reported protocol (Palmer *et al.*, 2001). Saliva was collected from healthy volunteers who had not taken antibiotics in the last three months or had food or drink in the two hours prior to donation. Each volunteer was given a piece of unflavoured chewing gum base, and asked to collect saliva in a Falcon tube. The collected saliva from at least five

volunteers was pooled, and placed on ice. One ml of 2.5 mM dithiothreitol (Sigma, UK) was added to each 100 ml of collected natural saliva. The mixture was kept on ice with continuous gentle mixing for 10 min. The saliva was centrifuged (J2-21, Beckman, USA) at 15,000 g for 30 min at 4°C. The supernatant was collected, sterilised by filtration through Stericup (SCGVU01RE), a vacuum-driven filtration system of 0.2 µm pore size filter (Fisher Scientific, Leics, UK). The filtered saliva was divided into 20 ml aliquots, and stored at -20°C until use.

### ***Artificial saliva preparation***

Artificial saliva was prepared following the protocol of Pratten *et al.* (1998). The formula contained 1 g/L Lab-Lemco (Oxoid, UK), 2 g/L yeast extract (Melford, UK), 5 g/L proteose peptone (Sigma, UK), 2.5 g/L hog gastric mucin (Sigma, UK), 0.35 g/L sodium chloride (Sigma, UK), 0.2 g/L calcium chloride (Sigma, UK), and 0.2 g/L potassium chloride (Melford, UK). Where required, 0.1% sucrose was included. Media were autoclaved at 121°C for 15 min, then 1.25 ml urea from a stock of 40% urea (Sigma, UK) was added to autoclaved saliva.

### ***MRD assembly and running***

The assembly of the MRD was performed in two stages. The first involved assembling two MRD prior to sterilisation. The assembled devices each had stainless steel biostuds in 12 plugs. The inlet and the outlet plastic tubes with their connectors were also attached to each MRD (Figure 2. 2a). Both MRD devices were wrapped entirely in tin foil, and autoclaved at 121°C for 15 min. The second stage of assembly was to prepare the MRD for running. The sterilised devices were connected to both natural saliva and artificial saliva with an inoculum of  $5 \times 10^7$  CFU/ml for each inoculated bacterial species, and artificial saliva bottles via their inlet tubes. These tubes were connected to a single tube passed through the pump (401U/DM3, Watson-Marlow, UK) that was adjusted to a flow rate of 20 ml/h. The outlet tubes were connected to the waste container. The complete assembly of apparatus was transferred into 37°C aerobic incubator (LTE Laboratory Thermal Equipment, UK) for running (Figure 2. 2b).

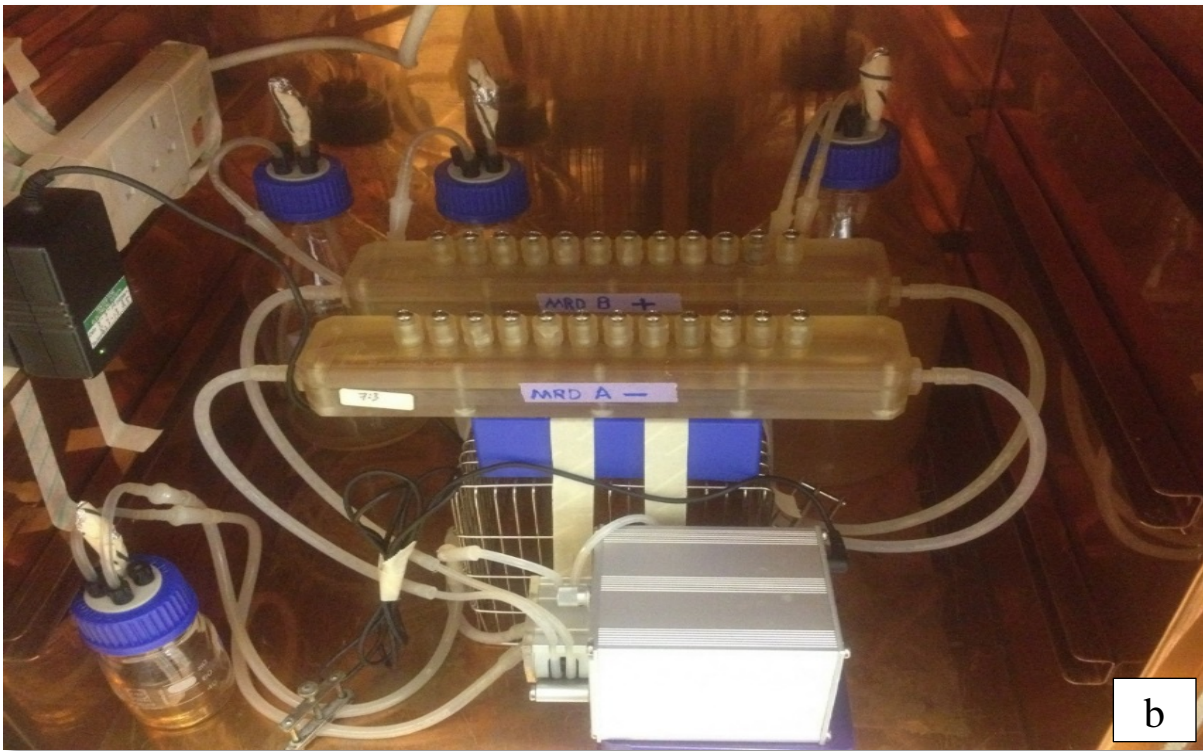
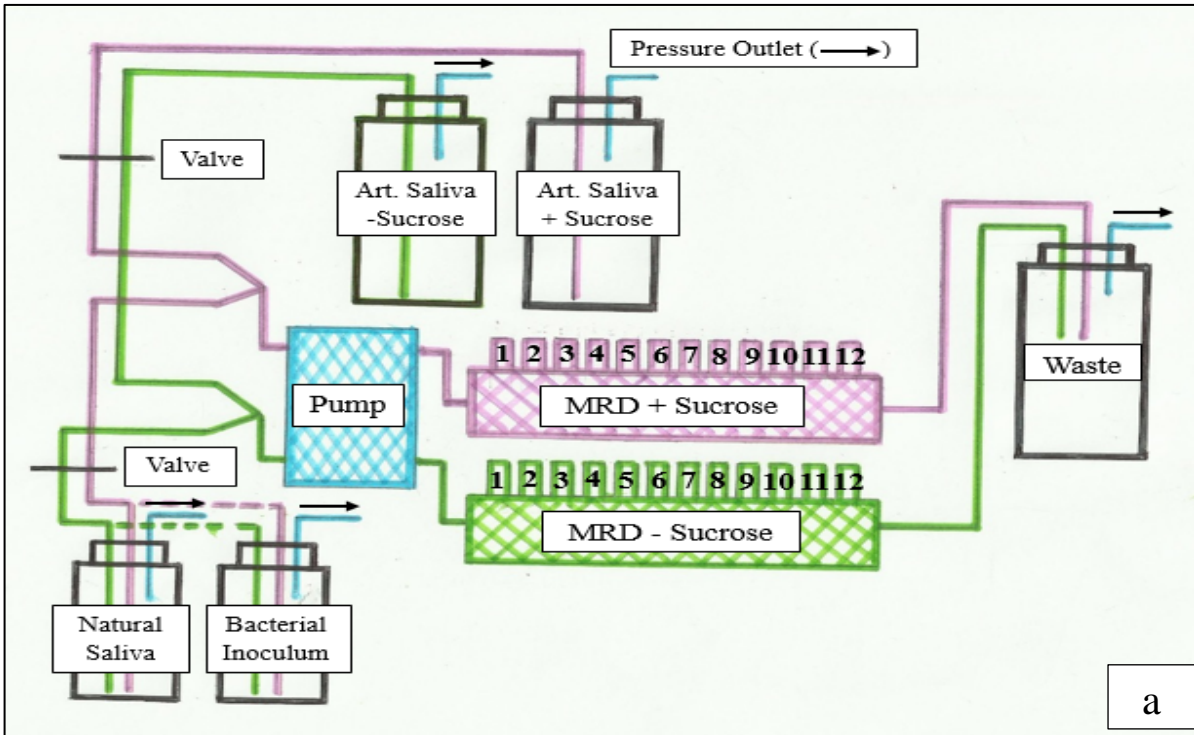

Figure 2. 2 Modified Robbins Devices (MRD). Assembly diagram (a), MRD in the 37°C incubator (b).

The running of two MRD positioned parallel to each other was commenced with the pumping of 40 ml of natural saliva. This allowed natural saliva to coat the surface of the stainless steel biostud. The formation of an acquired pellicle layer was then encouraged by stopping the MRD running for 1 h. The next re-running was performed in stages to pump 40 ml of artificial saliva inoculated with different volumes of bacterial inoculum. The inoculations

were taken from previously prepared bacterial stocks in the mid-logarithmic phase of growth. The different volumes of each species were derived according to CFU/ml of bacteria in these stocks, in order to obtain a final equal concentration of  $5 \times 10^7$  for each bacterial species. By the running of MRD over different stages, the biofilms were established:

### ***1- Stages of establishing early colonisers mixed species biofilms***

- Stage one, pumping of artificial saliva inoculated with 1,500  $\mu$ l of *A. oris* for 1 h, then MRD running stopped for at least 6 h, allowing the *A. oris* to colonise the biostuds surfaces.
- Stage two, 300  $\mu$ l of *V. parvula* and 6.6  $\mu$ l of *S. gordonii* DL1 inoculated together and pumped with artificial saliva for 1 h, and allowed to colonise by stopping MRD for at least 2 h.
- Stage three, by the end of the 2 h from stage two, the artificial saliva with or without 0.1% sucrose was pumped separately for 24 h in each MRD, to allow the development of independent biofilms groups either in the presence of sucrose or without sucrose. Then the MRD running was stopped for biofilm harvesting, and re-run for an additional 24 h, for a total run period of 48 h.

### ***2- Stages of establishing mixed species biofilms with S. mutans***

- Early colonisers mixed species biofilms were established for 24 h as mentioned in (1).
- For biofilms that included *S. mutans* (UA159-GS5): the 40 ml of inoculated artificial saliva with 50  $\mu$ l of *S. mutans* was pumped after the first 24 h of MRD running, for 1 h, and allowed to colonise for at least 2 h. The MRD was re-run with the pumping of uncultured artificial saliva for an additional 24 h, for a total running period of 48 h.

### ***3- Stages of establishing monospecies S. mutans UA159 biofilms***

- Stage one, pumping of artificial saliva inoculated with 50  $\mu$ l of *S. mutans* UA159, for 1 h, and allowed to colonise for at least 2 h.
- Stage two, MRD was re-run, pumped separately in MRD uncultured artificial saliva with or without 0.1% sucrose for 24 h.

### ***Biofilm sample collection***

Biofilms cultured with and without 0.1% sucrose were collected at different times after inoculation, and different investigations were undertaken on these biofilm samples. To quantify bacterial cells by qPCR, four biostuds were collected from each MRD. The biofilms were harvested from the biostuds' surfaces using mini disposable cell scrapers (Biotium, Hayward, CA), resuspended in PBS, and prepared for cDNA extraction (see Section 2.2.1). Biofilms were also collected for processing for SEM visualisation. Others were collected for

FISH labelling, and EPS and eDNA fluorescent detection, and imaged by a Confocal Laser Scanning Microscope (CLSM). The samples were retrieved when necessary without having to dismantle the system. Three independent runs of the MRD were performed for each different experimental condition.

## 2.4 Preparation of Tooth Section Studs

### 2.4.1 Preparation of silicone models

Silicone rubber base impression material (Imprint™ 4VPS Impression Material, 3M ESPE, UK) was used to make an impression of the stainless steel biostud. The impression material was placed in a plastic screw cup, and before setting the stainless steel biostud was pressed into the material to form an impression within the silicone base. When the silicone base was polymerised, the stainless steel biostud was removed and a negative copy of the stud was obtained (Figure 2. 3).

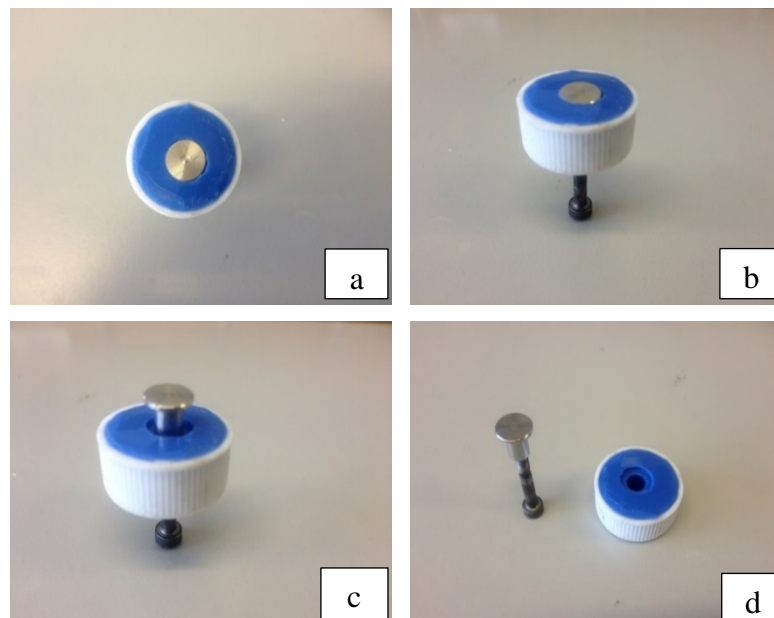

Figure 2. 3 Preparation of a negative copy of a stainless steel biostud, using silicon rubber base impression material. Pressing the biostud in the silicon impression base (a and b). Removal of the biostud after the setting of the material (c). Stainless steel biostud final negative copy (d).

### 2.4.2 Preparation of tooth section

Tooth samples were obtained from a tooth bank in the Dental Materials lab (Newcastle University). Ethical approval was not required for these anonymised stored samples at the time the study was conducted. Intact enamel surface was sectioned from extracted permanent molars. A circular shape section was cut from this surface using an Air Turbine Headpiece (Cutting Hand piece KAVO, Germany), and cutting disk bur (Skillbond Direct Ltd., UK). The dimensions of this circular shape were similar to that of the stainless steel biostud surface.

Tooth sections were stored in 1% Chloramine-T (Sigma, UK) at 4°C (Khvostenko *et al.*, 2015).

#### 2.4.3 Preparation of composite studs with tooth sections

Chemically cured composite material (Kent chemical cure composite base-950207, Kent Express Ltd., Gillingham, UK) was used to prepare studs resembling the stainless steel biostuds. A mixture of the composite material was made as a paste, and used to fill the negative silicone copy of the stainless steel biostud. Before the composite resin material was polymerised, the prepared tooth section was pressed gently into the material to give a flush surface. Once the composite had set, the stud was gently removed from the silicone model (Figure 2. 4a, b, and c). The final steps in the preparation of the tooth section stud were grinding and polishing. A grinder of 1200P (Metaserv Griander, Japan) was used to make the surface of the stud as flat as possible. Following this, polishing was performed with a polishing machine (Metaserv, Universal Polisher, Japan). The polishing materials (Buehler, USA) of three different polishing particle grades were used, graduating through particles of size 1.0 µm, 0.3 µm, and 0.05 µm. Polished tooth sections were sonicated three times using sonicate (Langford Electronic Ltd., UK) to remove any remnants of polishing materials. The finished tooth section composite studs (Figure 2. 4d, and e) were stored in 1% Chloramine-T at 4°C.

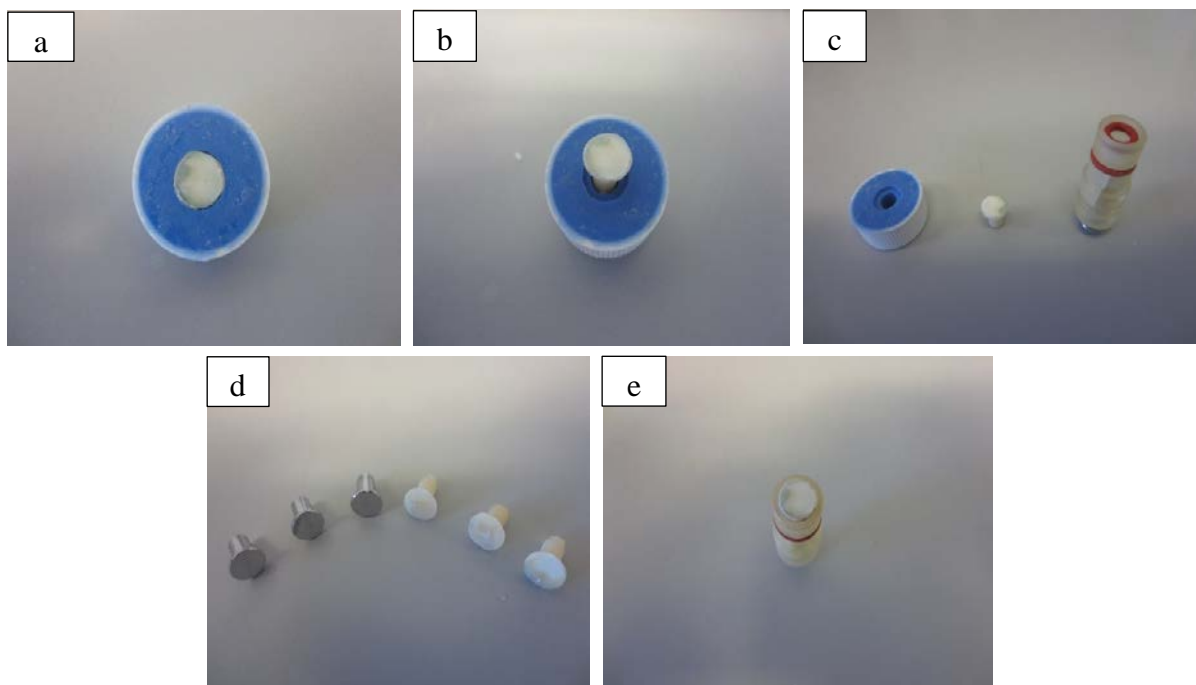

Figure 2. 4 Preparation of the composite stud with tooth section. Chemically polymerised composite within tooth section pressed into the negative copy of the stainless steel stud (a). Composite stud with tooth section ready for final finishing (b and c). A group of finished composite biostuds with tooth section in comparison with a group of stainless steel biostuds (d). Composite stud with tooth section placed into MRD plug (e).

## 2.5 Fluorescence Labelling

### 2.5.1 Labelling of bacterial cells by Fluorescence In Situ Hybridisation (FISH)

In order to check the specificity of the FISH PNA probe (Table 2. 3) in the detection of the bacterial cells in biofilm growth, the labelling was undertaken first on planktonic bacterial growth for *A. oris*, *S. gordonii*, *V. parvula*, and *S. mutans*, respectively. The bacterial cells were cultured for 24 h in appropriate growth media. Cultures were centrifuged at 3,800 g for 10 min at 4°C. Pellets were washed in 1 ml of PBS and centrifuged at 10,000 g for 5 min at 4°C. The PBS supernatant was removed and pellets were resuspended in 1 ml of fixation buffer [4% of Paraformaldehyde (Sigma, UK) in PBS]. Following fixation at 4°C for 1 h, cell suspensions were centrifuged at 10,000 g for 5 min at 4°C. The supernatant was removed, and pellets were washed in 1 ml of PBS. Cells were harvested at 10,000 g for 5 min at 4°C. The supernatant was removed and pellets were resuspended in 1 ml of dehydration buffer (50% ethanol in PBS). The dehydrated mixture was placed at -20°C for at least 30 min before processing.

A sample of 100 µl was taken from the dehydrated bacterial cell suspension, and centrifuged at 10,000 g for 5 min at 4 °C. The supernatant was removed and the pellets were resuspended in 1 ml of PBS. The mixture was centrifuged at 10,000 g for 5 min at 4°C. The supernatant was discarded and hybridisation buffer [0.9 M of NaCl, 20 mM of Tris-HCl pH 7.2, 0.01% of SDS, 25% Formamide (Sigma, UK)] containing 200 ng PNA molecular (Universal EUB338), and 250 ng (*S. mutans* MUT590), (Eurogentec, Belgium)/ 20 µl of buffer was added to the bacterial cells. This mixture was incubated at 46°C in a water bath for 2 h and protected from light by wrapping the Eppendorf tube with tin foil. The mixture was then centrifuged at 10,000 g for 5 min at 4°C, and the supernatant was discarded. Pellets were washed three times in 500 µl of washing buffer [10 mM of Tris pH 9.0, 1 mM of EDTA (Sigma, UK)]. The samples were incubated in a water bath at 55°C for 10 min between each washing step, and samples were centrifuged at 10,000 g for 5 min at 4°C each time to harvest cells. Following the third wash, the mixture was centrifuged at 10,000 g for 5 min at 4°C, and the supernatant was removed. Pellets were resuspended in 100 µl of washing buffer. This suspension was used to prepare samples for Epifluorescence microscope imaging, as described in Section 2.6.2.

Established biofilms from the MRD technique (see Section 2.3.2) were labelled by FISH to detect the *S. mutans* (UA159 or GS5) integration within preformed early coloniser mixed species biofilms. The biofilms were collected before and after *S. mutans* challenging and fixed with fixation buffer for 24 h. The fixed biofilms were processed by FISH labelling and steps of hybridisation, and washing was performed by the same method with the planktonic



bacterial growth. Following FISH labelling, the biofilms samples were prepared for CLSM imaging, as described in Section 2.6.3. At least two samples from independent MRD runs were analysed. In all cases, samples from the same condition appeared similar to one another. Representative images are shown in the results.

Table 2. 3 FISH PNA molecular probes used in this study.

PNA probes	Sequence	Reference
Universal EUB338	5'-Alexa488-GCTGCCTCCCGTAGGAGT-3'	(Amann <i>et al.</i> , 1990)
<i>S. mutans</i> MUT590	5'-Cy5-ACTCCAGACTTTTCCTGAC-3'	(Paster <i>et al.</i> , 1998)

### **2.5.2 Exopolysaccharide (EPS) labelling**

Exopolysaccharides in biofilms were detected using Fluorescent Brightener 28 (Sigma, UK), in combination with propidium iodide (PI) (Life Technology, USA) for labelling cells. Biofilms were treated first with 1 µl of PI/ ml of PBS for 15 min at room temperature. This was followed by the CFW of 0.001 g/ ml of distilled water for 15 min. Then the biofilms were prepared for CLSM examination and imaging, as described in Section 2.6.3. At least two samples from independent MRD runs were analysed. Samples from the same condition appeared similar to one another. Representative images are shown in the results.

### **2.5.3 Extracellular DNA (eDNA) labelling**

PicoGreen reagent (Quant-it™ PicoGreen dsDNA kit, Invitrogen, USA) was used to stain eDNA in biofilms. Cells were counterstained with Nile Red (Sigma, UK). From prepared Nile Red stock of 0.001 g/ml of DMSO (Sigma, UK), 10 µl were added to 990 µl of PBS, and the mixture used to treat the biofilms for 30 min at room temperature. Then, 1 µl PicoGreen reagent in 199 µl TE buffer was used to process the biofilms for 5 min. The volume of preparation was adjusted to fully immerse the biofilms. Following labelling, biofilms were imaged by CLSM. At least two samples from independent MRD runs were analysed, and in each case samples from the same condition appeared similar to one another. Therefore, representative images are shown in the results.

## **2.6 Microscopy**

### **2.6.1 Scanning electron microscopy (SEM)**

SEM was used for the examination of single or mixed species biofilms. Samples from static biofilms model (see Section 2.3.1), or from the MRD biofilms (see Section 2.3.2) were fixed

in 2% glutaraldehyde in Sorensens Phosphate Buffer for 24 h. Samples were rinsed twice for 15 min each with Sorensens Phosphate Buffer. Serial dehydration was performed by immersion in ethanol concentration of 25%, 50%, and 75%, respectively, for 30 min for each concentration. Additional dehydration was performed twice with 100% ethanol for 1 h each. Samples were dried at the critical point of carbon dioxide in a Baltec Critical Point Dryer CPD 030 (Leica Geosystems Ltd., Milton Keynes, UK). Dehydrated samples were mounted on aluminium stubs with Achesons Silver Dag (Agar Scientific, Essex, UK), and stored overnight to ensure dryness. Samples were coated with gold, standard 15 nm, using the Polaron E5000 SEM coating Unit (Quorum Technologies Ltd., East Sussex, UK), and examined using a TESCAN VEGA LMU (Tescan, Cambridge, UK). Digital images were obtained with TESCAN software (Vega3 control software, version 4.2.13.1). At least two samples from static monoculture biofilms of each pioneer coloniser, or from independent MRD runs, were analysed and representative images are shown in the results. In all cases, the independent samples from each strain or condition looked similar to one another.

### ***2.6.2 Epifluorescence microscope***

The Epifluorescence microscope (Zeiss Axio, Germany) was used to examine bacterial cells labelled with FISH probes (Section 2.5.1). Ten  $\mu$ l of labelled cells were spread on the surface of the slide. Samples were dried at room temperature, and fixed by quickly passing over the flame. A drop of hard setting Vectoshield mounting medium without DAPI (Vector Laboratories, CA) was applied, a cover slip was placed, and samples were allowed to set at room temperature and then stored at 4°C for at least 24 h prior to examination by the Epifluorescence microscope. Images were obtained using ZEN supplied software (ZEN2-blue edition). The samples were protected from light exposure throughout. At least two samples from each species were prepared and visualised under the epifluorescent microscope. In all cases, the replicate samples of the same species and FISH probe appeared similar to one another. Representative images are shown in the results.

### ***2.6.3 Confocal Laser scanning microscopy (CLSM)***

Biofilms were examined using the CLSM (Nikon A1, Japan). The preparation of biofilms for CLSM was the same, whatever the fluorescent labelling experiment. Biostuds with labelled biofilms were placed on the holder, and a drop of Vectosheild mounting medium without DAPI was added. A coverslip was placed over the mounting medium, and the samples were kept at room temperature to set. The biostuds were fixed on slides, and the whole samples

were stored at 4°C for at least 24 h before microscopic examination. Wavelengths of excitation/emission for different dyes are given in Table 2. 4. Microscopic images from the CLSM were obtained with NIS supplied software (NIS-Elements AR 4.40.00). At least two samples from independent MRD runs were analysed. In each case, samples from the same condition appeared similar to one another. Representative images are shown in the results.

Table 2. 4 Excitation/Emission of fluorescence dyes used in this study.

Fluorescence dyes	Excitation (nm)	Emission (nm)
AlexaFluor488	465-495	515-555
Cy5	510-560	590 (Long Pass) (LP)
Fluorescent Brightener 28	340-380	435-485
PI	510-560	590 (LP)
Nile Red	510-560	590 (LP)
PicoGreen	465-495	515-555

## 2.7 Statistical Analysis

All experiments were performed three times independently, and calculations were performed using Microsoft Excel (2013). The representation of the results in graphic form was achieved using SigmaPlot (Exact Graphs and Data Analysis 12.5). Statistical significance was estimated by unpaired T-test, and Bonferroni correction. Differences were considered significant when  $p. \leq 0.05$ .



## Chapter 3. Establishment of Early Coloniser Mixed Species

### Biofilms

#### 3.1 Outline and Aims

The initial development of biofilms on enamel surfaces involves the attachment of species that can adhere to the salivary pellicle and establish in early biofilms. The majority of these pioneer colonisers belong to a relatively small group of bacteria genera, including *Actinomyces*, *Streptococcus*, *Haemophilus*, *Capnocytophaga*, *Veillonella*, and *Neisseria* (Marsh, 2012; Welch *et al.*, 2016)

The pioneer colonisers pave the way for the integration of later colonisers into the biofilm, for example by providing attachment sites or local microenvironments that support a more diverse range of microorganisms. Later colonisers include potentially pathogenic species such as *S. mutans*. The presence of *S. mutans* or other highly acidogenic and aciduric species in dental plaque is undesirable since they can lead to dysbiosis of the microbial community and ultimately to the development of dental caries (Takahashi and Nyvad, 2011; Nyvad *et al.*, 2013).

Oral streptococci are commonly the most abundant bacteria in the early stages of dental plaque development (Zhou *et al.*, 2015). These bacteria produce a range of cell surface adhesins that mediate attachment to the acquired salivary pellicle. For example, Hsa and the Antigen I/II proteins SspA and SspB of *S. gordonii* have been shown to bind immobilised gp340, a key component of the salivary pellicle (Jakubovics *et al.*, 2009; Jakubovics and Kolenbrander, 2010). These adhesins also mediate interactions with other oral bacteria, known as coaggregation. Hsa has been shown to bind *Veillonella* spp. (Zhou *et al.*, 2015), whilst SspA and SspB are required for interactions with different *Actinomyces* spp. (Jakubovics *et al.*, 2005; Struzycka, 2014).

*S. gordonii*, *Actinomyces* spp. and *Veillonella* spp. are frequently identified together in early dental plaque communities. In general, although there are variations from one individual to another, and most studies have found that *Streptococcus* spp. dominate over the early stages of colonisation, within 4-8 h of cleaning teeth (Peters *et al.*, 2012). *Actinomyces* spp. and *Veillonella* spp. are also frequently observed at this point (Palmer *et al.*, 2006; Al-Ahmad *et al.*, 2009).

Most of the early colonising *Streptococcus* spp. and *Actinomyces* spp. produce moderate amounts of organic acids from dietary sugars and these species may start to acidify the biofilm (Takahashi and Nyvad, 2011). This produces conditions that will start to favour more strongly acidogenic and aciduric species such as *S. mutans*. At the same time, the presence of *Veillonella* spp. in the biofilm can help to remove acids produced by bacterial metabolism, since *Veillonella* spp. use lactic acid for growth. Many studies have shown that the presence of *Veillonella* spp. correlates with acidogenic bacteria in dental plaque, and even with dental caries (Egland *et al.*, 2004).

There is also evidence that early colonisers of dental plaque compete with later colonisers such as *S. mutans*. *S. gordonii* can inhibit *S. mutans* and *Actinomyces naeslundii* by producing H<sub>2</sub>O<sub>2</sub>, and this inhibition is stronger under aerobic growth conditions compared with a strictly anaerobic environment. However, the presence of glucose can reduce the inhibition effect of H<sub>2</sub>O<sub>2</sub> by decreasing its production (Jakubovics *et al.*, 2008; Zheng *et al.*, 2011; Zhu and Kreth, 2012).

Moreover, the order of colonisation may be important since early colonising streptococci such as *S. sanguinis* can outcompete *S. mutans* if inoculated first and allowed to establish, but are outcompeted by *S. mutans* if the *S. mutans* is given the opportunity to grow before the addition of *S. sanguinis* (Kreth *et al.*, 2005b). In natural dental plaque, early colonising streptococci such as *S. sanguinis* or *S. gordonii* almost always colonise before *S. mutans* and it is therefore not clear how *S. mutans* can integrate into the biofilm in the face of competition from other streptococci.

Clearly, there is strong evidence that interbacterial interactions play a major role in the development of cariogenic dental plaque communities. Many models of early colonisers' biofilms have included only a single species (Mishra *et al.*, 2010; Zheng *et al.*, 2012), although some have included two or more (Egland *et al.*, 2004; Hashino *et al.*, 2013). Recently, *in vitro* models have been described which include mixed-species communities containing early colonisers of dental plaque with *S. mutans* in order to account for some of these interactions. For example, a three-species system including *S. mutans*, *S. gordonii* and *A. oris* has been developed and used to show that L-arginine can favour the early colonisers at the expense of *S. mutans* (He *et al.*, 2016). However, to the best of my knowledge, no models have looked at *S. mutans* attachment to a preformed mixed-species early coloniser biofilm,

and therefore the mechanisms that enable the establishment of *S. mutans* in a pre-formed biofilm are currently not clear.

The aim of this chapter is to establish a stable model of early coloniser mixed species biofilms which can then be challenged with later colonisers such as *S. mutans*.

The objectives were to:

- 1- Assess the ability of the three pioneer species to develop monospecies biofilms and the impact of 0.1% sucrose on their development.
- 2- Develop qPCR based methods to quantify three early colonisers within mixed species biofilms.
- 3- Assess the structure of early coloniser biofilms.
- 4- Evaluate whether biostuds are suitable substrates for biofilm development in comparison to tooth sections.

### 3.2 Development of Monospecies Biofilms

Monospecies biofilms were developed from *A. oris* MG1, *S. gordonii* DL1, and *V. parvula* PK1910 to evaluate colonisation by individual species, and to characterise cell morphology in biofilms. In addition, the effects of sucrose on monospecies biofilms development were evaluated.

#### 3.2.1 SEM of monospecies biofilms

The three pioneer colonisers were initially cultured in monospecies with and without 0.1% sucrose, and were grown anaerobically on sterile glass coverslips in a simple static biofilm model, as described in Section 2.3.1. The developed biofilms were prepared for SEM imaging, as shown in Section 2.6.1. The SEM images for each bacterial monospecies biofilm (Figure 3. 1) illustrate all species formed biofilms with and without 0.1% sucrose. The presence of sucrose appeared to affect *A. oris* MG1 and *S. gordonii* DL1 biofilms growth; there was slightly stronger growth in some areas of *A.oris* MG1, and *S. gordonii* DL1 biofilms in the presence of sucrose (Figure 3. 1b, and d) rather than the absence (Figure 3. 1a, and c). Such an effect was not shown with *V. parvula* PK1910 biofilms (Figure 3. 1e and f), and although this was seen across the samples, it was not quantified. Different biofilm matrix structures were observed including threads and granules, particularly in *A. oris* MG1 (Figure 3. 1a and b), and *V. parvula* PK1910 (Figure 3. 1e and f) biofilms. However, the appearance of *A. oris* MG1 biofilms matrix structures was slightly more with 0.1% sucrose (Figure 3. 1b), in comparison to without (Figure 3. 1a). Such observations were not seen either with *S. gordonii* DL1 (Figure 3. 1c and d), or with *V. parvula* PK1910 (Figure 3. 1e and f) biofilms.



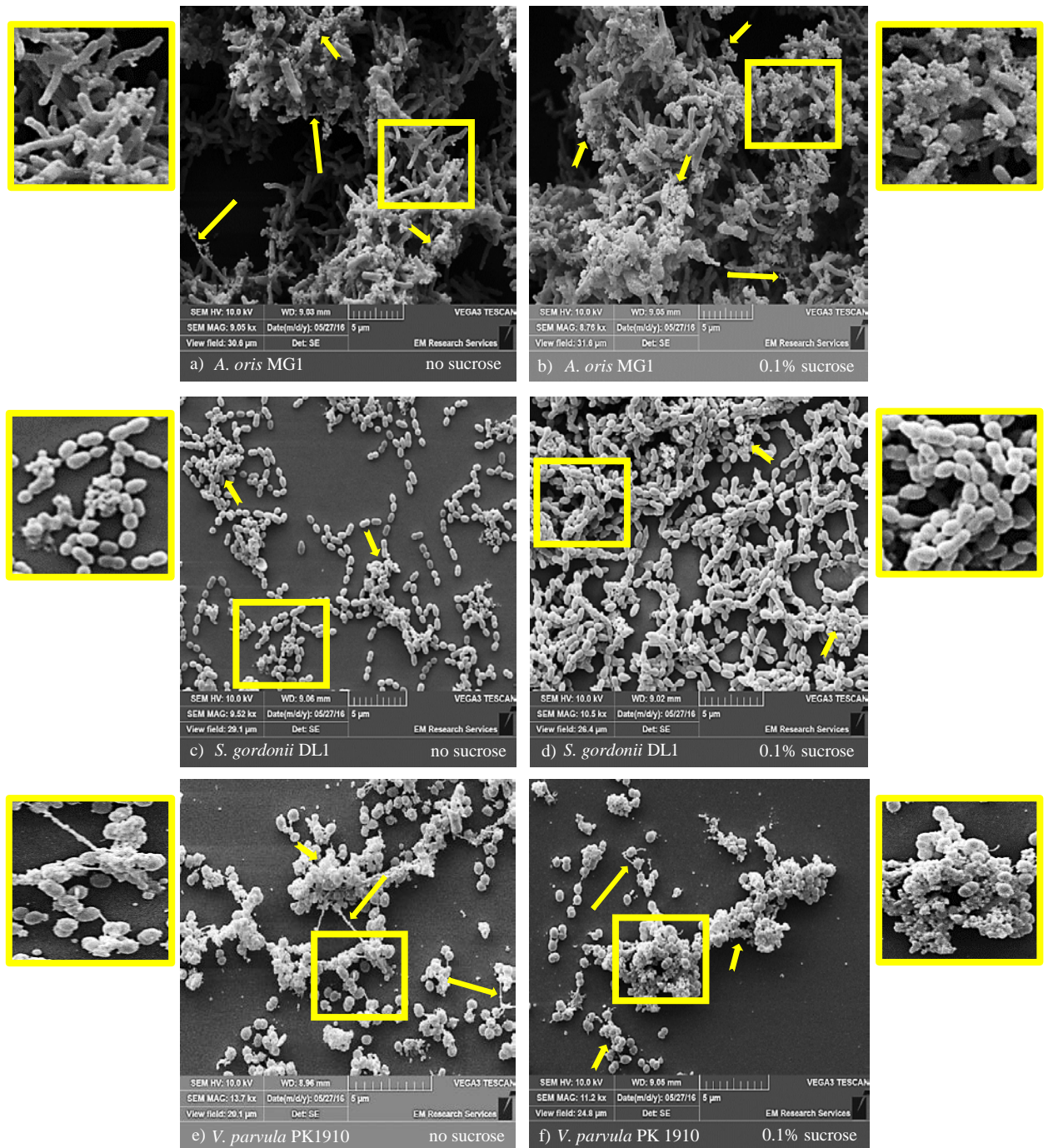

Figure 3. 1 SEM images of monospecies biofilms cultured without sucrose (left panels), and with 0.1% sucrose (right panels). *A. oris* MG1 (a, b), *S. gordonii* DL1 (c, d), and *V. parvula* PK1910 (e, f). Biofilm matrix substances distributed between the bacterial cells appear as long threads (long arrows), or as granules on the surfaces of the bacterial cells (short notched arrows). The enlargement views (Yellow squares) showed closer visualisation of the matrix substances as well as the bacterial cells, and the matrix structures appearance was slightly more in *A. oris* with sucrose presence (b) than that in sucrose absence (a).

### 3.3 Development of Early Coloniser Mixed Species Biofilms

Early coloniser mixed species biofilms were developed with and without 0.1% sucrose to establish reproducible models of biofilms to investigate the later integration of *S. mutans* within mixed species biofilms. The biofilms were developed using the MRD that was assembled and run as described in Section 2.3.2.

#### 3.3.1 Development of qPCR assays to enumerate different species

The amplified PCR fragments of extracted DNA from *A. oris* MG1, and *S. gordonii* DL1 had already been cloned and transformed in previous studies. The cloning and transforming of an amplified PCR fragment from *V. parvula* PK1910 DNA extraction will first be described in the following subsections, followed by a description of the standardised qPCR assays for the quantification of the bacterial cells in different established biofilms.

#### TOPO cloning of a PCR fragment

Cloning was performed to obtain highly purified plasmid DNA of known molecular weight, to be used as a standard for qPCR. From the extracted *V. parvula* PK1910 DNA, the 16S rRNA gene was amplified by PCR using 0063F and 1387R primers. The PCR fragment was run on a 1% agarose gel (Figure 3. 2).

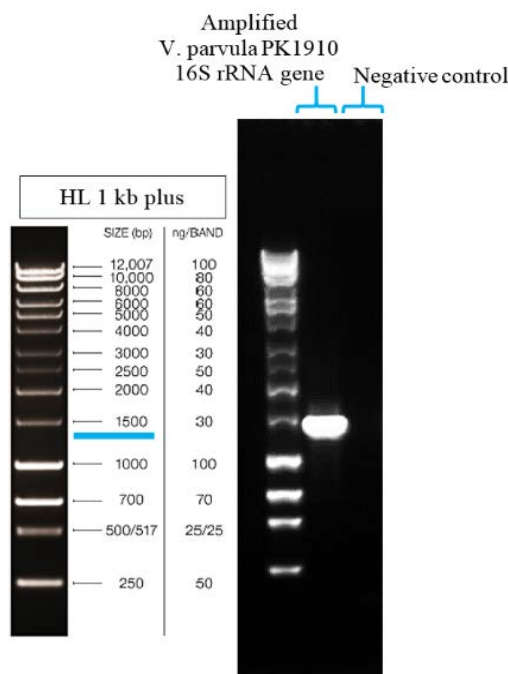

Figure 3. 2 Agarose gel electrophoresis of an amplified *V. parvula* PK1910 PCR fragment, and a negative control. The Hyper-Ladder 1 kb plus was used as reference. The size of the amplified 16S rRNA was 1,300 bp, as expected (blue line). Nothing was shown within the negative control.

The PCR product was cloned in PCR2.1-TOPO to generate PCR-Vp, and used to transform *E. coli* as described in Section 2.2.5, and illustrated in Figure 3. 3.

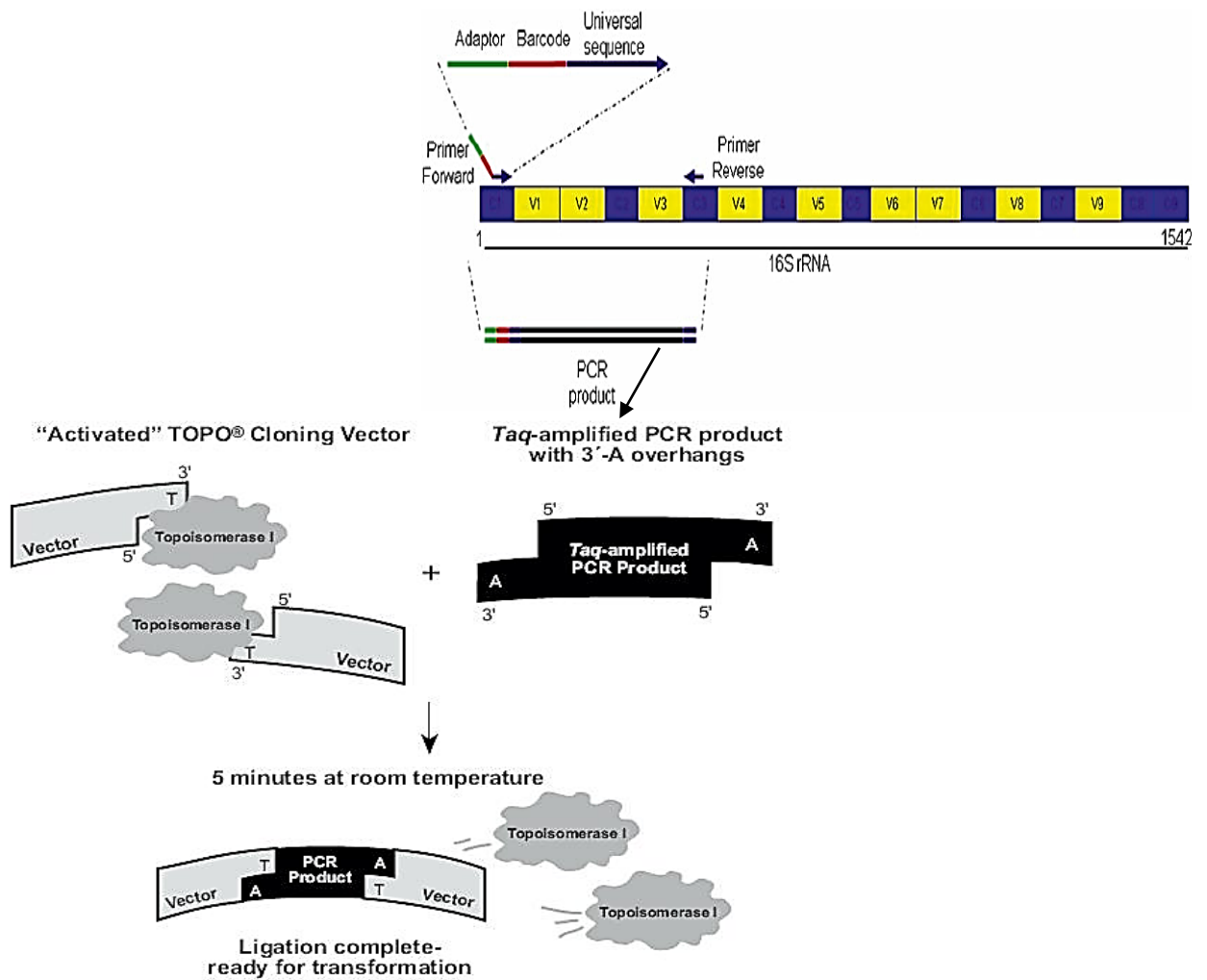

Figure 3. 3 Diagram demonstrating the TOPO cloning of the PCR amplified *V. parvula* PK1910 16S rRNA gene. Adopted from Del Chierico *et al.* (2015).

### ***Plasmid extraction and sequencing***

An inoculum of transformed cells was grown as described in Section 2.2.5. The plasmid was extracted as shown in Section 2.2.6, and visualised by 0.8% agarose gel electrophoresis (Figure 3. 4). A sample was sent for sequencing to ensure that the PCR fragment was inserted correctly within the TOPO PCR 2.1 vector plasmid sequence, and that the PCR amplification had not introduced errors.

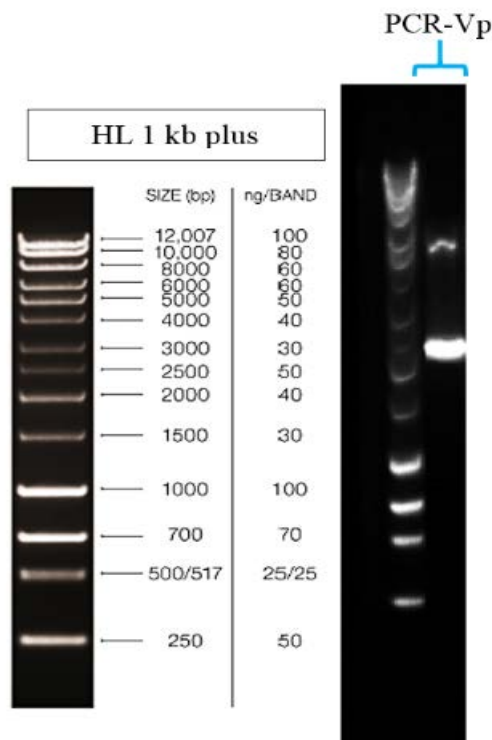

Figure 3. 4 Gel electrophoresis of PCR-Vp. The reference to check the product size was Hyper-Ladder 1 kb plus. There were multiple bands, as expected for an undigested plasmid.

***PicoGreen assay to measure standard DNA concentration***

Plasmids of TOPO-Ao, TOPO-Sg, and TOPO-Vp were extracted from *E. coli*. The concentration of each bacterial DNA standard template was calculated using the PicoGreen kit (Life Technology) following the manufacturer’s instructions, as described in Section 2.2.7. A PicoGreen standard curve was generated (Figure 3. 5) to calculate the Molar concentration of plasmid DNA. The plasmids stocks concentrations were: 317 ng/μl for PCR-Ao, 348 ng/μl for PCR-Sg, and 145 ng/μl for PCR-Vp.

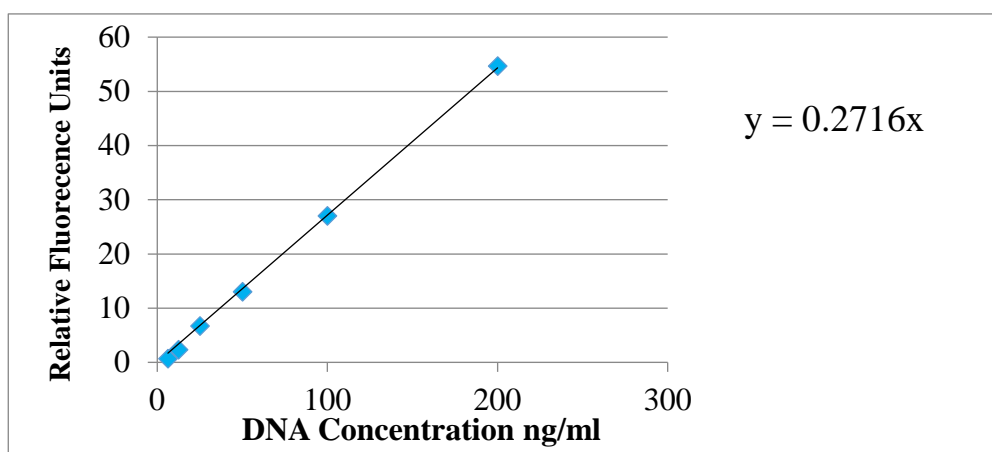

Figure 3. 5 PicoGreen standard curve to measure the concentration of template DNA. The equation of the curve is shown.

### qPCR optimisation

Standard curves were run for each primer/probe set using ten-fold serial dilutions of plasmid DNA. An example of the qPCR standard curve *V. parvula* PK1910 is shown in Figure 3. 6.

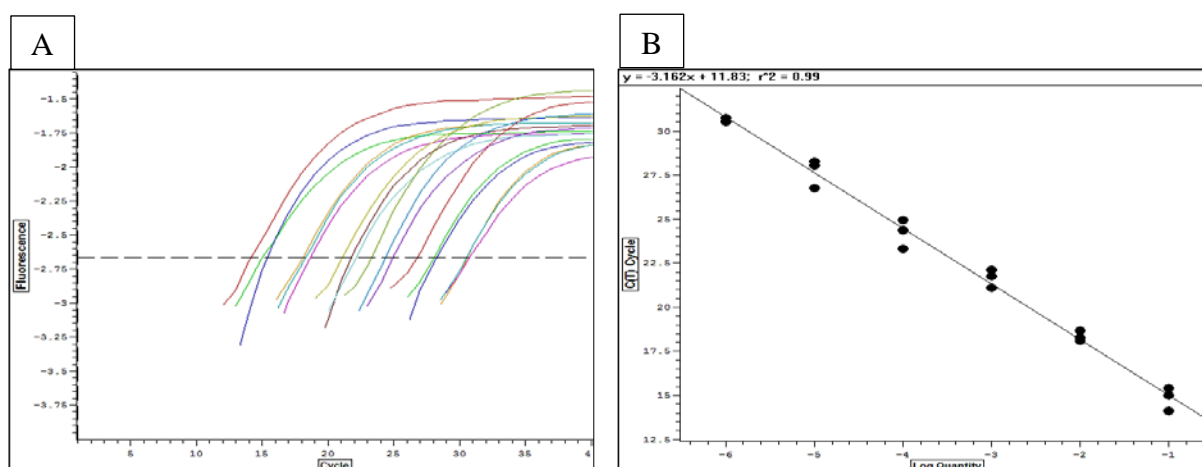

Figure 3. 6 (A) qPCR standard curve example of ten-fold serial dilutions of *V. parvula* PK1910 standard plasmid, (B) individual amplification. The standard plasmid dilutions were plotted against the cycle threshold.

To ensure that primer/probe sets amplified target DNA efficiently, the reaction efficiencies were calculated for each set (Table 3. 1). In all cases, reaction efficiencies were between 95% and 105%, indicating that qPCR reaction was working well.

Table 3. 1 Efficiency of qPCR standard curve for each standard plasmid ten-fold dilution of species used in this study. Efficiencies calculated from the gradient of the curve (see Figure 3. 6B).

Species targets	Cloned PCR target size	Reaction efficiency
<i>A. oris</i> MG1	110bp	103.5% ( $\pm$ 8.9)
<i>S. gordonii</i> DL1	96 bp	97.3% ( $\pm$ 12.0)
<i>V. parvula</i> PK1910	84 bp	104.8% ( $\pm$ 10.5)

The amplified pTOPO-*Ao* with primers hktE F/R and hktE P, pTOPO-*Sg* with primers hsdR F/R and hsdR P, and pTOPO-*Vp* with primers 16S rRNA F/R and 16S rRNA P were run on 3% agarose to estimate the size of each amplicon. In each case, the amplified fragments were of the expected size: 110bp for the *A. oris* target, 96bp for *S. gordonii*, and 84bp for *V. parvula* (Figure 3. 7).

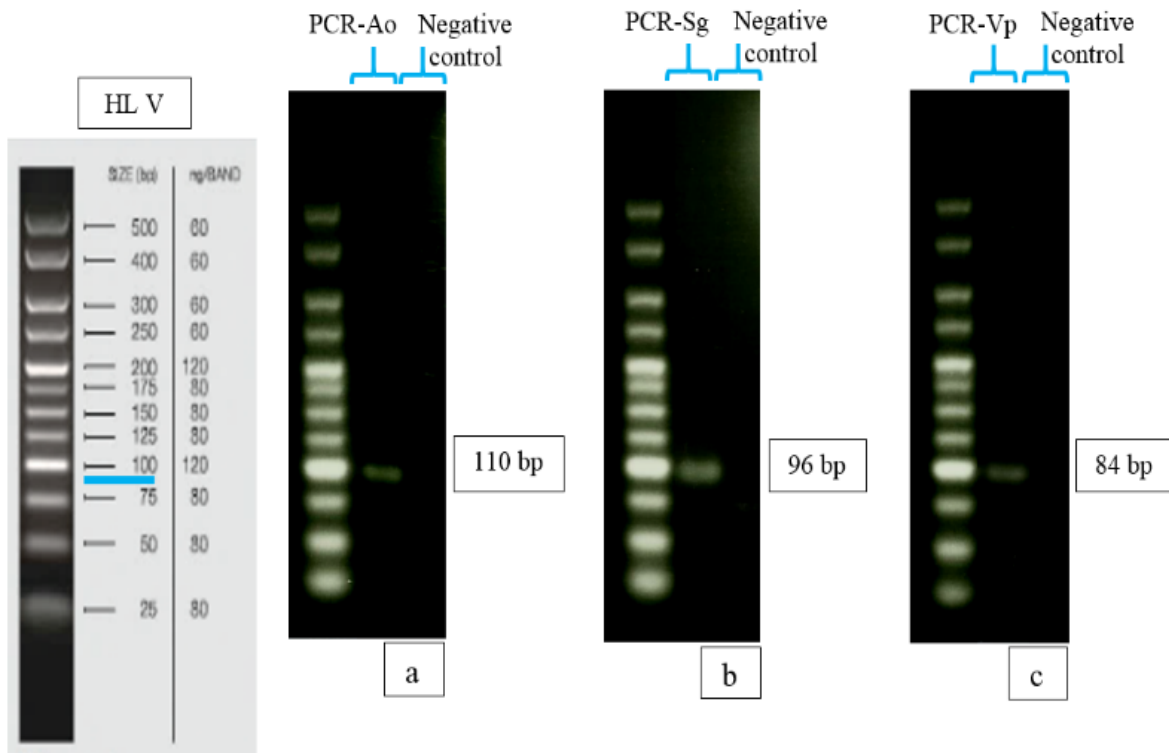

Figure 3. 7 Gel electrophoresis of the three pioneer bacterial species plasmids. The size of qPCR amplified targets were as expected. pTOPO-*Ao* 110 bp (a), pTOPO-*Sg* 96 bp (b), and pTOPO-*Vp* 84 bp (c). No amplification was shown with the negative controls. The Hyper-Ladder V was used as reference.

### 3.3.2 Enumeration of bacterial cells in early coloniser mixed species biofilms

Having developed qPCR methods for the quantification of three different species, MRDs were set up, inoculated with the three species, and run for 48 h with and without 0.1% sucrose. Samples of biofilms established in the MRD were collected after 24 h and 48 h. The DNA was extracted from biofilms, as described in Section 2.2.1, and each species was quantified by qPCR (Figure 3. 8). The results showed that the biofilms were reproducible and there were no significant differences ( $p > 0.05$ ) between any of the individual species with and without 0.1% sucrose (Figure 3. 8a). In addition, the total numbers of bacteria present were not significantly different in the presence or absence of sucrose (Figure 3. 8b).

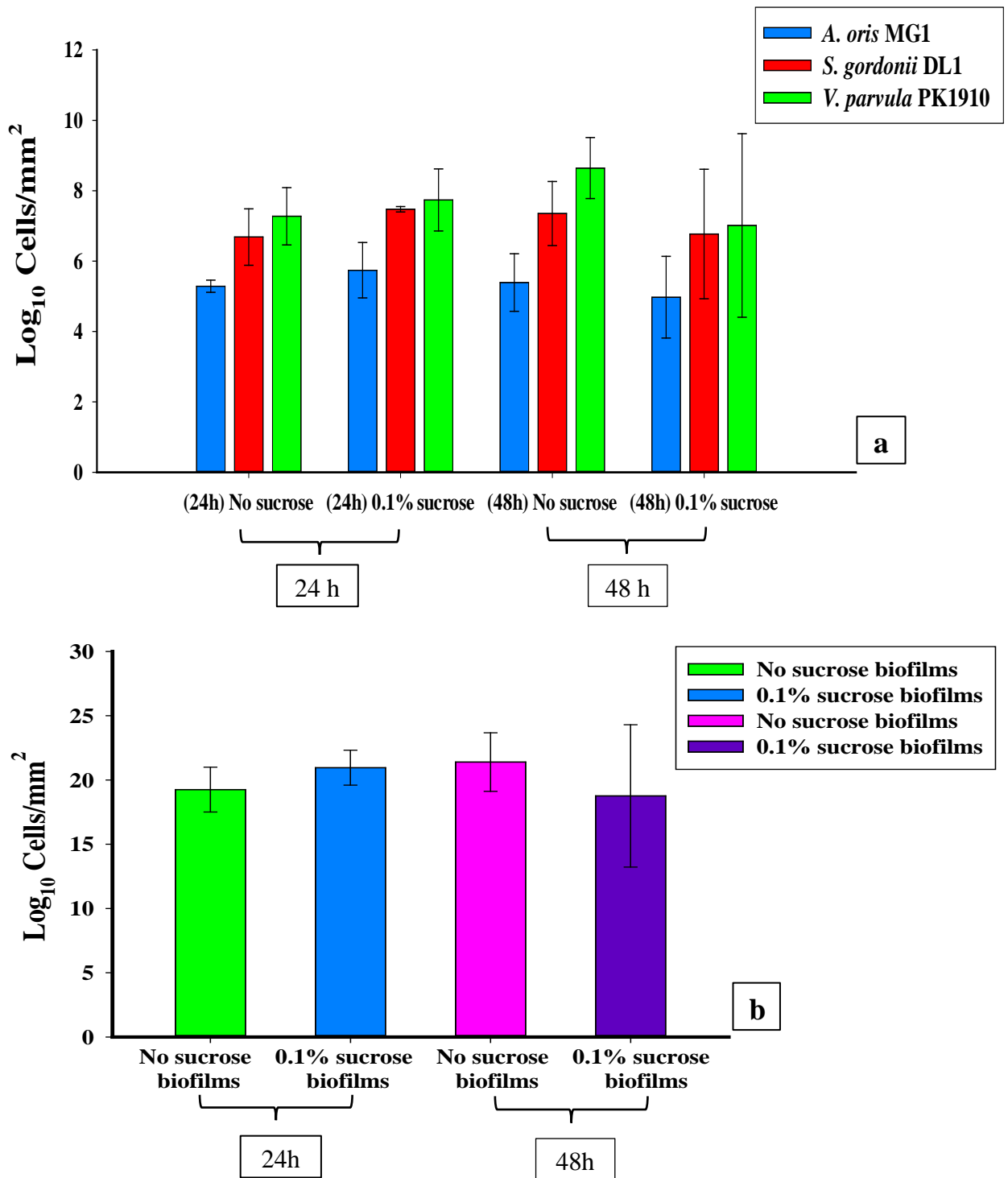

Figure 3. 8 Quantification of bacterial cells in early coloniser mixed species biofilms. Bacterial cells/mm<sup>2</sup> of stainless steel biostuds were quantified by qPCR after 24h and 48h in the MRD without and with 0.1% sucrose. Mean  $\pm$  SD of three independent experiments is shown. There were no significance differences ( $p > 0.05$ ) between any species in the presence vs absence of sucrose (a). The same record was noted in the total number of bacterial cells within the biofilms community (b).

### 3.3.3 SEM of early coloniser mixed species biofilms

The early coloniser mixed species biofilms were visualised by SEM (Figure 3. 9). In biofilms with sucrose (Figure 3. 9b), chains of cocci appeared more predominant when compared with biofilms grown in the absence of sucrose (Figure 3. 9a). In addition, matrix substances were apparent as thread like forms or granules in biofilms with and without 0.1% sucrose. *A. oris* cells were clearly apparent as the only rod-shaped species. However, in contrast to monocultures (Figure 3. 1), all *A. oris* cells appeared to be straight rods in the mixed-species biofilms.

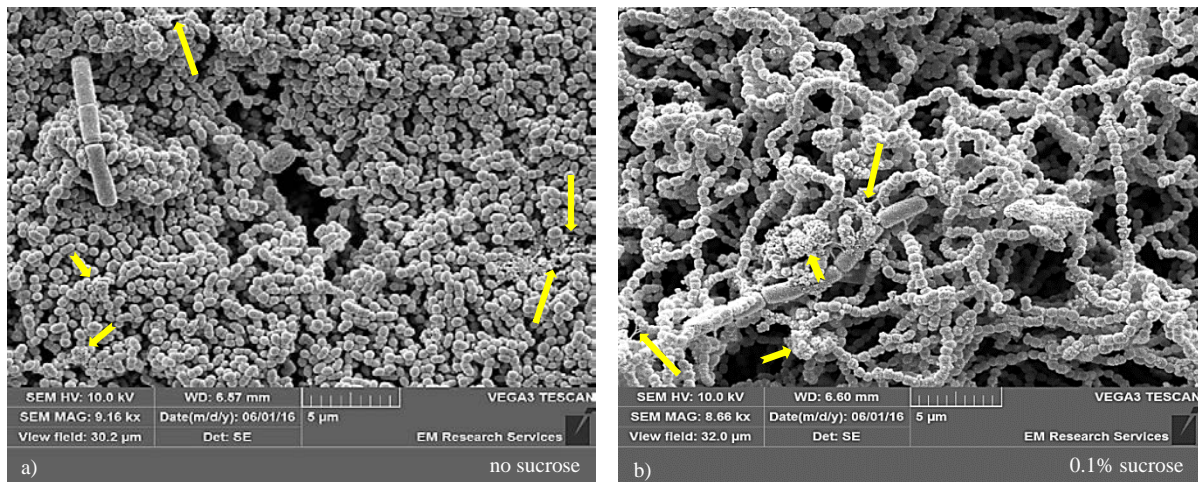

Figure 3. 9 SEM images of early coloniser mixed species biofilms, without sucrose (a), and with 0.1% sucrose (b). Chains of cocci tended to be more predominant in biofilm samples with 0.1% sucrose (b). Biofilm matrix substances were distributed between the bacterial cells either as threads (long arrows), or as granules on the surfaces of the cells (short notched arrows).

### 3.3.4 Comparison of tooth surfaces versus biostuds as biofilm substrate by SEM

To assess if the stainless steel biostud was a suitable substrate for the MRD model, composite studs containing intact enamel sections of permanent molars were prepared as described in Section 2.4.3. These studs were used in parallel with stainless steel biostuds as substrates for biofilm development. From SEM, there was no qualitative difference in the appearance of biofilms on tooth sections from those developed on biostuds (Figure 3. 10). On both substrates, biofilms cultured in 0.1% sucrose showed granular structures on the surfaces of the bacterial cells (Figure 3. 10c, and d). Chains of cocci were clearly apparent in biofilms cultured with 0.1% sucrose on tooth sections or on biostuds (Figure 3. 10c, and d), and were less obvious in biofilms cultured without sucrose (Figure 3. 10a, and b). The SEM images also showed differences in surface texture between the two biofilm substrates. Enamel pores were clearly apparent within the tooth section, while the metal biostud surface was obviously non-porous (Figure 3. 10e, and f).



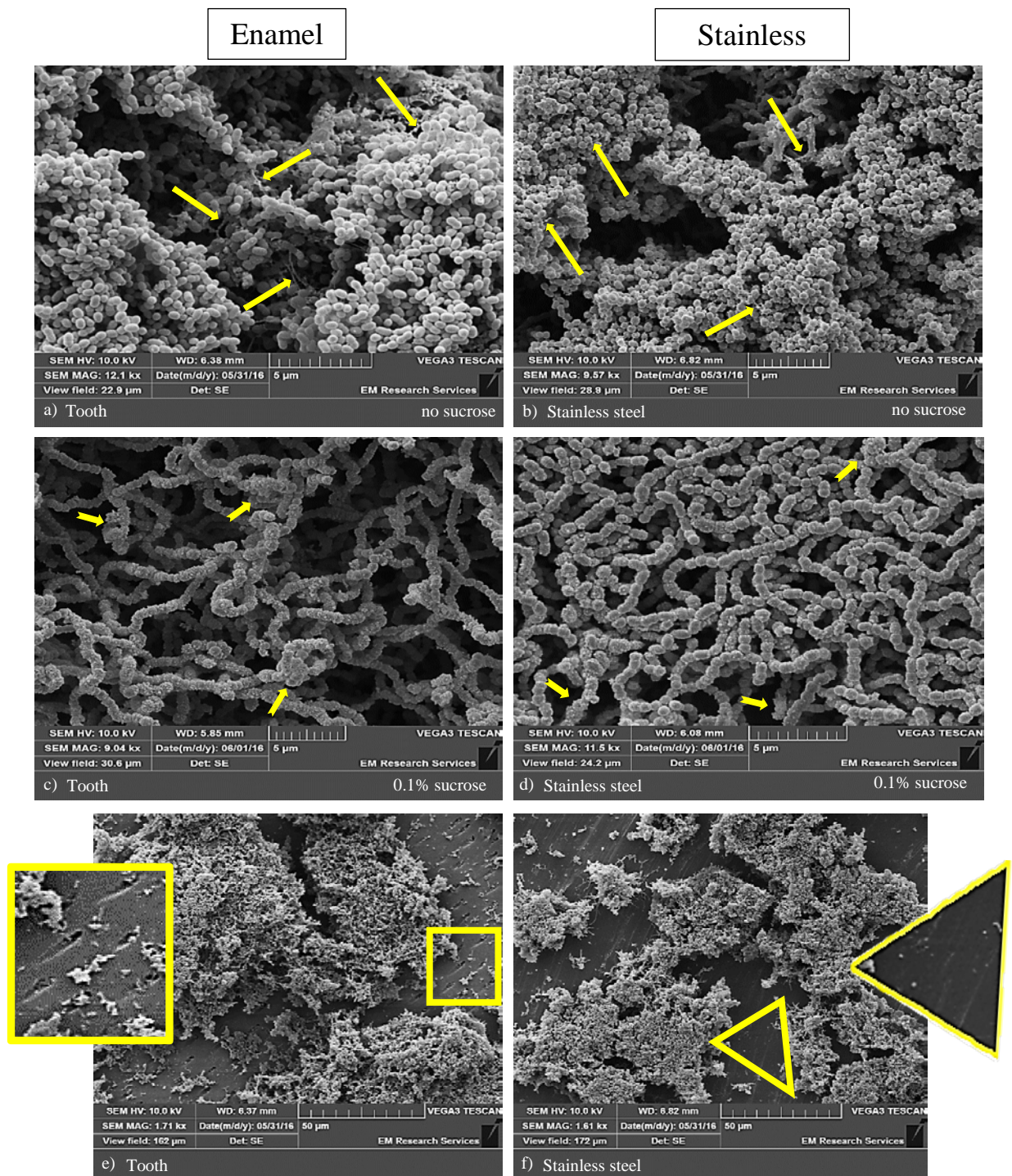

Figure 3. 10 SEM images of early coloniser mixed species biofilms developed on tooth sections in the MRD without and with 0.1% sucrose (a, c), in comparison to stainless steel biostuds (b, d). The images showed different bacterial phenotypes. Chains of cocci tended to be more predominant in biofilm samples with 0.1% sucrose (c, d). Biofilm matrix substances were distributed between the bacterial cells either as threads (long arrows), or as granules on the surfaces of the cells (short notched arrows). Enlargement views (e, f) showed differences between the textures of the two surfaces. Enamel pores (yellow square in e), and stainless steel surface (yellow triangle in f). Qualitatively, there were no major differences between biofilms developed on tooth sections, and those on stainless steel.

### 3.4 Discussion

Monoculture of *S. gordonii* DL1, *A. oris* MG1, and *V. parvula* PK1910 showed that each bacterial species had its own morphological appearance. *A. oris* MG1 appeared as clumps of pleomorphic rods. *S. gordonii* grew as chains of slightly elongated coccoid cells. *V. parvula* cells were smaller than *S. gordonii* and appeared to be spherical. The growth of these pioneer species in mixed culture biofilms had an unexpected effect on *A. oris* MG1, which appeared only as straight rods. This was consistent with SEM images of *A. oris* in mixed species biofilms throughout the project. However, changes of this nature have not previously been reported in *A. oris*. Therefore, the culturing of *A. oris* in mixed species biofilms needs further investigation to understand the cause of such morphological changes. However, other bacterial species have shown morphological changes when grown in mixed species biofilms versus their single species biofilms. An isolate TM7 demonstrated morphological changes, when cultured with different oral bacterial species, that differ in appearance from their very long filaments in their monospecies biofilms (Soro *et al.*, 2014). These changes vary from long filaments in biofilms with *Actinomyces oris* or *Fusobacterium nucleatum* to small rods or cocci with *Parvimonas micra*, or *Streptococcus gordonii* biofilms. Such alterations were correlated with the metabolic conditions of the mixed cultures biofilms, as well as to signalling from the other biofilms bacterial partners.

Matrix structures were observed in each monospecies biofilm as well as in the early coloniser mixed species biofilms, and appeared as threads or granules scattered between the microbial cells in the biofilms. In general, biofilm matrices are composed of a variety of macromolecules and exopolysaccharides (EPS), proteins, lipids, nucleic acids, and even lipopolysaccharides have been identified (McSwain *et al.*, 2005; Jain *et al.*, 2013).

*Actinomyces* has been shown to produce exopolysaccharides such as soluble fructans, from the action of fructosyltransferase Ftf exoenzyme (Bergeron and Burne, 2001; Yamane *et al.*, 2013). As a sucrose metabolism end-product, fructans may serve as an additional carbohydrate source and may aid bacterial aggregation in the oral cavity (Yeung, 1999; Rozen *et al.*, 2001; Zijngel *et al.*, 2011). *S. gordonii* also has a single glucosyltransferase Gtf exoenzyme, known as GtfG, which can catabolise sucrose and synthesise soluble and insoluble glucans in the biofilm matrix (Huang *et al.*, 2014; Ricker *et al.*, 2014).

The addition of 0.1% sucrose during biofilms growth of *A. oris* monocultures or mixed-species cultures resulted in a slight increase in EPS compared with no sucrose, while such observation was not demonstrated within *S. gordonii* and *V. parvula* monospecies biofilms

matrix structures. Previous studies have also demonstrated slight increases in EPS levels with 0.1% sucrose. For example, the effect of different sucrose concentrations on EPS formation were assessed in mixed species biofilm established from *A. oris*, *S. oralis*, and *S. mutans* (Xiao *et al.*, 2012). At 1% sucrose, there was more EPS accumulation compared with 0.1% sucrose. However, even 0.1% sucrose resulted in some EPS, and biofilms were clearly distinct from those grown in 1% glucose, where there was only a thin layer of bacterial cells, and no detectable EPS. In the current work, the use of 1% sucrose was avoided since such high concentrations have previously been found in our research group to result in occlusions of the tubing (Yassin *et al.*, 2016).

Since the biofilm matrix in *S. gordonii* and *V. parvula* biofilms was not affected by sucrose, it is likely that these matrices were primarily composed of macromolecules that are not dependent on sucrose. Another constituent in biofilm matrix is the extracellular DNA (eDNA), and there is evidence that extracellular DNA (eDNA) is an important component of the dental plaque biofilm matrix (Rostami *et al.*, 2017). *S. gordonii* produces eDNA in a lysis-independent process that is linked to H<sub>2</sub>O<sub>2</sub> production (Zheng *et al.*, 2011; Zhu and Kreth, 2012). The processing of the developed mixed species biofilms is investigated in the next chapters of this study, to detect the presence of some of these extracellular polymers. As the bacterial community in mixed species biofilms is variable, the composition and structure of the biofilm matrix is also variable, and both are changeable with time and influenced by the condition of the local environment (Hojo *et al.*, 2009; Yang *et al.*, 2011). *Veillonella*, another pioneer species in early colonisers mixed species biofilms, and another Gram negative bacterial species, produces membrane vesicles in culture filtrates (Bladen and Mergenhagen, 1964; Zhou *et al.*, 1998). The vesicles may make an important contribution to the biofilm matrix (Schooling and Beveridge, 2006).

The bacterial cells of early colonisers' biomass in mixed species biofilms were quantified by qPCR. Plasmid DNA was used as standard template for quantification, and the suitability of plasmids as qPCR standard templates has previously been assessed (Hou *et al.*, 2010). A serial dilution of different DNA standards was amplified and used to create an absolute qPCR standard curve, such as a PCR amplicon, a manufactured oligonucleotide, a chromosomal DNA, and a plasmid DNA. A significant impact on the accuracy of absolute quantification by qPCR has been demonstrated when using plasmid DNA containing the target sequence as a quantification standard. Plasmids are widely used as standards for qPCR and have generally been considered suitable templates due to their high stability and little degradation during

storage, ease in preparation, and reproducibility (Hou *et al.*, 2010; Lin *et al.*, 2011). However, there are some concerns that they can overestimate, leading to the consideration of linear plasmids for future work. Nevertheless, the efficiency differences between the used circular plasmid and the suggested linear plasmid were not significant (Hou *et al.*, 2010; Oldham and Duncan, 2012).

The concentration of each plasmid template was measured using PicoGreen assay, and the bacterial cells were counted based on the number of plasmid molecules calculated from the measured concentration. UV absorbance and the fluorescent dye-binding method are two molecular biology assays used to quantify DNA (Lin *et al.*, 2011). A PicoGreen double-strained DNA (dsDNA) reagent assay has recently become a more popular means of quantifying DNA based on the binding of a fluorescent dye, since it is a relatively sensitive and specific fluorescent dye-binding method of low cost.

One important limitation of qPCR is that it does not distinguish between dead bacterial cells and live ones. There are a number of alternative methods that can be used to quantify viable cells. Measuring colony forming units (CFU) is standard practice for planktonic cells. However, it is less appropriate for biofilms, since it is difficult to fully disperse cells from the surface and to break up cell aggregates (Ammann *et al.*, 2013). Although there is often a good correlation between CFU and cell counts determined by qPCR, CFU counts tend to be lower (Klein *et al.*, 2012; Ammann *et al.*, 2013). Therefore, it has been suggested that it is not appropriate to combine the use of CFU counting and qPCR for analysis (Ammann *et al.*, 2013). Live:dead stain can be used to quantify the proportion of live cells in a biofilm (Blanc *et al.*, 2014). However, this does not distinguish between different species. In addition, the research laboratory at Newcastle is in a separate location from the CSLM. The logistics of taking samples to the CSLM mean that there is always a delay between collecting biofilms and visualising them, and it is possible that some cells may die during transit. A variant of qPCR has been introduced using ethidium monoazide (EMA) or propidium monoazide (PMA) to photo crosslink DNA in dead cells or in the biofilm matrix and prevent PCR amplification (Sherry *et al.*, 2016). In theory, PCR amplification then just comes from live cells. However, it is important to conduct extensive optimisation for this method to ensure that the signal genuinely distinguishes live from dead cells (Cangelosi and Meschke, 2014; Elizaquível *et al.*, 2014). It is not easy to identify conditions that will be appropriate for multiple species, including gram-negative and gram-positive bacteria, in a single sample. Therefore, there is no easy method for quantifying live cells in biofilms.

Since the main aim of the model was to investigate the accumulation of microbial cells within the biofilm over a relatively short time frame, it was felt that qPCR was the most appropriate method as it is highly sensitive, it is species-specific and the extraction of DNA template is relatively straightforward. It was reasoned that qPCR would detect the growth of cells as an increase in biomass on the substratum, and indeed relatively high concentrations of cells were observed at the surface after incubation for 24 h, in some cases reaching  $>10^8$  cells/mm<sup>2</sup>. There was no significant change in the quantity of any species between 24 h – 48 h. It is possible that there may have been some cell death over this time, which would not necessarily have been detected by qPCR. However, in other models it has been shown that cell viability remains relatively stable over this period. For example, in a 96-well microplate model containing the early colonisers *Streptococcus oralis* ATCC1 9811™, *Actinomyces naeslundii* DSM 43013, and *Veillonella dispar* DSM 20735, in addition to the periodontal pathobiont *Porphyromonas gingivalis* DSM 20709, live:dead staining with SYTO9 and propidium iodide demonstrated cell viability of 97.9% ( $\pm 0.1$ ) and 95.2% ( $\pm 0.5$ ) after 24 h and 48 h, respectively (Kommerein *et al.*, 2017). Further, there was no significant decrease in viable cells between 24 h and 48 h using ‘vitality qPCR’, in which extracellular DNA or DNA within dead cells was cross-linked with propidium monoazide to prevent PCR amplification. Similarly, in a five-species model containing *Actinomyces naeslundii*, *Veillonella dispar*, *Fusobacterium nucleatum*, *Streptococcus sobrinus* and *Streptococcus oralis* viable cell numbers, measured by dispersing the biofilm and counting CFU, rapidly increased between 0.5 h and 16.5 h, then slowed between 16.5 h and 40.5 h, and remained stable from 40.5 h to 64.5 h (Guggenheim *et al.*, 2001). Even after 64.5 h, total CFU were at 85% of the maximum level. Even though it is likely that most cells remained viable after 48 h, it was considered prudent to use 24 h biofilms as the basis for examining the integration of *S. mutans* in the next sections of work. By 24 h the biofilms had reached maturity and there was no benefit to extending the incubation.

Using qPCR, it was shown that *S. gordonii* and *V. parvula* accumulated to relatively high numbers on surfaces within 24 h, and there was no significant difference between the levels of these species. *V. parvula* was able to grow in an aerobic condition although it is a strict anaerobe. In contrast, the *A. oris* counts were consistently 10-100X lower than *S. gordonii* or *V. parvula*. The different relationship between these pioneer bacteria in mixed species biofilms may play a role in driving the relative levels of each species. The three pioneer species biofilms with *A. oris*, *S. gordonii*, and *V. parvula* were stable and reproducible. Quantitatively, it appeared that *S. gordonii* and *V. parvula* grew mutualistically, whereas *A.*

*oris* maintained lower numbers. In dual-species or three-species biofilms containing early, middle, and late colonisers of oral biofilms, a number of synergistic and antagonistic interactions have been documented (Periasamy *et al.*, 2009; Periasamy and Kolenbrander, 2009b; Periasamy and Kolenbrander, 2009a; Periasamy and Kolenbrander, 2010). In general, it is difficult to predict which species will grow synergistically. However, *Veillonella* has been shown to be compatible with many other species and can grow mutualistically in biofilm models with *F. nucleatum* and *A. actinomycetemcomitans* (Periasamy and Kolenbrander, 2009a). *A. oris* is often present at relatively low numbers in biofilm models when co-cultured with Streptococci and other species. For example, *A. oris* was lower than the other species in a 3-species model containing *Veillonella* sp. and *P. gingivalis* (Periasamy and Kolenbrander, 2010).

In dual species biofilms of *S. gordonii* and *A. oris*, the cell numbers of *A. oris* were lower than their growth in monocultures after 24 h, likely due to antagonism from the production of H<sub>2</sub>O<sub>2</sub> by *S. gordonii* (Jakubovics *et al.*, 2008). In contrast, the coaggregation between these two species can protect *S. gordonii* against the oxidative damage of self-produced H<sub>2</sub>O<sub>2</sub>. On the other hand, intergeneric coaggregation between *S. gordonii* and *V. parvula* is an important factor in cooperative communications between these species in mixed biofilm, and can be related to the survival of anaerobic bacteria such as *V. parvula* in aerobic conditions (Bradshaw *et al.*, 1998). In addition, the existence of *V. parvula* with *S. gordonii* encouraged the expression of amylase in *S. gordonii*, and this enables them to ferment the carbohydrate and produce lactic acid as an end product (Egland *et al.*, 2004; Johnson *et al.*, 2009; Washio *et al.*, 2014). The production of lactic acid establishes a food chain for *V. parvula* that can metabolise it and use as a source of energy.

The addition of 0.1% sucrose did not have a statistically significant effect on the numbers of early colonisers in mixed species biofilms. The numbers of each pioneer species were unaffected, and the community composition also appeared to be stable, regardless of the presence/absence of 0.1% sucrose. Bacterial diversity with 0.1% and 0.5% sucrose was assessed *in vitro* mixed species biofilms established from growing saliva inoculum, and compared with control biofilms established without sucrose (Edlund *et al.*, 2013). The diversity of the biofilm cultured in a Schenk and Hildebrandt (SHI) medium supplemented by higher sucrose concentration of 0.5% provided a bacterial community profile more akin to the diversity in the natural saliva inoculum. The biofilm cultured in 0.1% sucrose was similar to that grown in 0.5% sucrose, with the main exception that there were increased levels of

subgingival bacterial members, such as *Porphyromonas* in the biofilm community profile. In contrast to both biofilms established with sucrose, the no sucrose control had less diversity and a community dominated by unidentified *Streptococcus* species and *S. mitis*. Therefore, relatively low levels of sucrose (0.1%) appear to be a relatively weak selective agent for oral biofilms and particularly for biofilms formed from early colonisers. Thus, it should be possible to assess the effects of 0.1% sucrose on *S. mutans* colonisation without dramatically affecting the underlying early coloniser biofilm.

Hydroxyapatite has previously been used as a substrate for biofilms in the MRD (Blanc *et al.*, 2014). We were unable to find hydroxyapatite discs of the appropriate dimensions from a commercial source, and so we chose to use an inert surface such as stainless steel. Using MRD stainless steel biostuds as a substrate on which to establish biofilms in comparison with human enamel showed that, qualitatively, biofilms on stainless steel were similar to those on a natural substrate. Therefore, the MRD stainless steel biostuds were selected as the biofilm substrate throughout this project.

In summary, a model has been developed for establishing reproducible early coloniser mixed species biofilms from three pioneer colonisers of dental plaque. These biofilms can then be challenged with later colonisers such as *S. mutans* strains. The addition of 0.1% sucrose had no observable effect on bacterial cell numbers within biofilms, or on the biofilms community, but slight differences were shown in the presence of sucrose in the extracellular matrix of *A. oris* monoculture, and in the early colonisers mixed species growth. Biofilms developed on the stainless steel biostuds were not qualitatively different from those developed on tooth sections, indicating that stainless steel is a suitable substrate for biofilm development in the MRD.





## Chapter 4. Incorporation of *S. mutans* UA159 into Preformed Biofilms

### 4.1 Outline and Aims

In Chapter Three, stable models of early coloniser mixed species biofilms with and without 0.1% sucrose were developed using the MRD. This chapter focuses on how the preformed early colonisers mixed species biofilms were challenged with *S. mutans* UA159, to assess the ability of *S. mutans* to colonise a pre-existing biofilm. Early colonisers such as *S. gordonii*, *V. parvula* and *A. oris* provide binding sites and environmental conditions that facilitate the establishment of many other species. Further colonisation and development of early coloniser biofilms leads to the establishment of highly organised and well differentiated multispecies biofilm communities, with the attachment of the secondary colonisers. The strength of biofilms is supported by the presence of extracellular polymeric substances within the biofilm matrix, including EPS, for example (Xiao *et al.*, 2012).

*S. mutans* can attach to substrates by sucrose-independent and sucrose-dependent mechanisms (Banas, 2004). Several sucrose-independent adhesions are expressed by *S. mutans* cells and may promote binding to the salivary acquired pellicle (Wan *et al.*, 2003; Lévesque *et al.*, 2005). These sucrose-independent adhesions include P1 that are also known as antigen I/II, SpaP, and Pac (Sullan *et al.*, 2015), fructanase (FruA), wall-associated protein A (WapA), which is also identified as collagen-binding adhesion (Han *et al.*, 2006), wall-associated protein E (WapE), and dextranase (DexA) (Lévesque *et al.*, 2005; Oli *et al.*, 2012). Sucrose-dependent adhesion involves the production of extracellular glucans by glucosyltransferases (GTFs) exoenzymes of *S. mutans* or other species, which are then substrates for binding by glucan binding proteins Gbps (GbpA, GbpB and GbpC) (Lynch *et al.*, 2007; Lynch *et al.*, 2013).

Following the adhesion of *S. mutans*, more EPS accumulates, leading to the development of mature biofilms. *S. mutans* is particularly adept at producing EPS, since it has three different GTFs exoenzymes (GtfB, GtfC, and GtfD) that can synthesise glucans from sucrose (Bowen and Koo, 2011). In addition, *S. mutans* produces a fructosyltransferase (Ftf) exoenzyme that creates fructans from sucrose. In addition to providing binding sites for *S. mutans*, the extracellular glucans and fructans increase the bulkiness and structural consistency of the biofilm extracellular matrix (Klein *et al.*, 2009; Habimana *et al.*, 2014).

Environmental factors such as nutrients and pH levels have important effects on *S. mutans* biofilms maturation (Shumi *et al.*, 2010). Local colonisation and accumulation of bacteria on the teeth can be promoted by the EPS formed on surfaces, causing the assembly of an intricate polymeric matrix, and accumulation of microcolonies. The resident microorganisms in this matrix are protected from antimicrobials such as chlorhexidine (CHX) and are difficult to remove (Matsui and Cvitkovitch, 2010; Shumi *et al.*, 2010; Senadheera *et al.*, 2012).

*S. mutans* is an adaptable species when competing against close families of the same nutrient sources or niche. *S. mutans* produces several bacteriocins that can kill a range of oral bacteria and release their DNA, which in turn is an important factor in stabilising the architecture of biofilms (Li *et al.*, 2001; Kreth *et al.*, 2005a; Kolenbrander *et al.*, 2010). Bacteriocin production is co-ordinated by peptide signalling molecules such as competence stimulating peptide (CSP) (Dufour *et al.*, 2011; Lemme *et al.*, 2011) and sigma X-inducing peptide (XIP) (Mashburn-Warren *et al.*, 2010). *S. mutans* may also change the biofilm environment by reducing the pH, since *S. mutans* can ferment a variety of dietary carbohydrates to organic acids. The acidification of dental plaque inhibits many competing species and ultimately may lead to dental caries (Matsui and Cvitkovitch, 2010; Xu *et al.*, 2011). To survive in such an acidic environment, *S. mutans* can employ different mechanisms such as up-regulating the membrane-bound F<sub>0</sub>F<sub>1</sub>-ATPase system to pump protons out of the cell. This assists in maintaining its internal pH value (Kuhnert *et al.*, 2004) by shifting the fatty acid composition of the cell membrane from saturated fatty acids to unsaturated. In turn, this changes the transmembrane proteins activity by affecting the permeability of the cell membrane to protons important for maintaining pH (Baker *et al.*, 2016), and there is also an increase in lactic acid excretion (Fozo and Quivey, 2004; Cross *et al.*, 2016). These mechanisms are part of the acid tolerance response (ATR), which can explain the ability of *S. mutans* to succeed in an environment that many competing oral bacteria find harmful (Matsui and Cvitkovitch, 2010; Senadheera *et al.*, 2012).

To quantify *S. mutans* in mixed-species biofilms, it is important to use a method selected for *S. mutans*. Quantitative PCR using TaqMan probes is a highly sensitive and specific method of detecting and quantifying the numbers of *S. mutans* when grown in monoculture biofilms, or when inoculated to challenge preformed early colonisers mixed species biofilms (Yoshida *et al.*, 2003; Childers *et al.*, 2011). Fluorescent In Situ Hybridisation (FISH) was also used in this study to visualise *S. mutans* integration within the preformed early coloniser mixed species biofilms. Labelling the bacterial cells within the mixed species biofilm improves

understanding of the spatial relationships of different bacterial species with each other. This method has previously been applied in combination with CLSM to visualise the three-dimensional arrangement of the biofilms and detect *S. mutans* (Al-Ahmad *et al.*, 2010; Meagher *et al.*, 2010).

The aim of this chapter is to establish a model for studying the incorporation of *S. mutans* into preformed biofilms.

The objectives were:

- 1- To establish monoculture biofilms of *S. mutans* UA159, and evaluate the effects of sucrose on bacterial cell numbers, biofilm structure, and EPS in the biofilm matrix.
- 2- To assess the integration of *S. mutans* UA159 into pre-established early coloniser mixed species biofilms, and specifically the effects on *S. mutans* numbers, biofilm structure, and visualise *S. mutans* position within the biofilm.
- 3- To assess the effects of *S. mutans* challenge on the early colonisers.

## 4.2 Development of *S. mutans* UA159 Monospecies Biofilms

Initially, monospecies biofilms of *S. mutans* UA159 were established with and without 0.1% sucrose in the MRD. This was undertaken to see how *S. mutans* appeared in monoculture biofilm, to assess their growth ability without sucrose, and to determine if the addition of 0.1% sucrose would have an effect on *S. mutans* numbers in monospecies growth. Prior to establishing the biofilm, a qPCR method was developed for the specific enumeration of *S. mutans*.

### 4.2.1 Development of qPCR assay to enumerate *S. mutans* in biofilms

The *S. mutans* UA159 amplified PCR fragment was cloned in plasmid pTOPO-*Sm* in a previous study (Yassin, 2015). Plasmid pTOPO-*Sm* was extracted from *E. coli* and quantified using the PicoGreen assay. The quantified DNA concentration was 103 ng/ $\mu$ l. Then, the plasmid target was amplified with primers gtfB F/R and probe gtfB P by qPCR with a reaction efficiency of 103.7% ( $\pm$  6.1). The amplified product size was checked on a 3% agarose gel and was shown to be 112 bp as expected (Figure 4. 1).

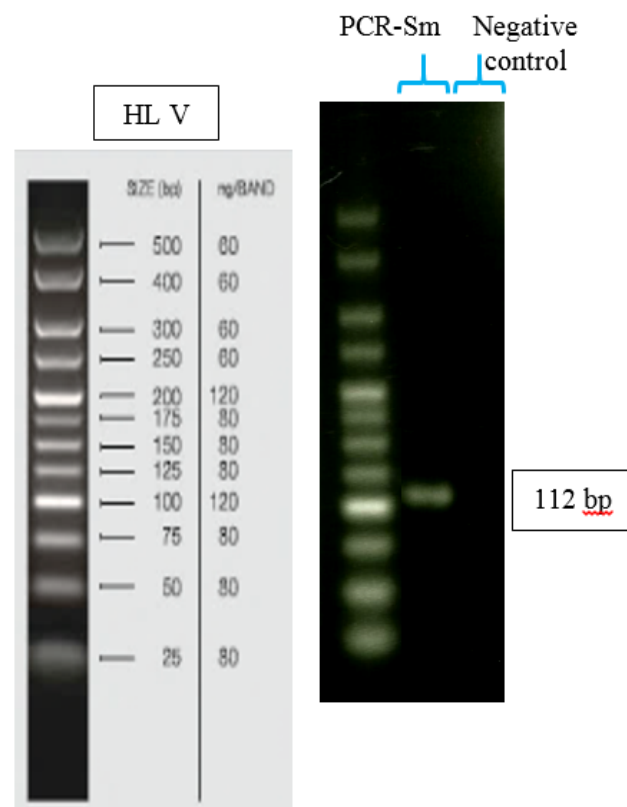

Figure 4. 1 Gel electrophoresis of PCR fragment amplified from pTOPO-*Sm* with primers gtfB F/R and probe gtfB P. The size of the qPCR amplified target was 112 bp, as expected. There was no amplification with the negative control. Hyper-Ladder V was used as reference.

#### 4.2.2 Quantification of *S. mutans* UA159 in the monospecies biofilm by qPCR

Monoculture biofilms of *S. mutans* were established in the presence or absence of 0.1% (w/v) sucrose using the same approach as previously described in Section 2.3.2. The biofilms were harvested after 24h. The biofilms DNA were extracted as described in Section 2.2.1, and quantified by qPCR. The number of *S. mutans* in monoculture biofilms showed a small but non-significant difference in the cell density with versus without 0.1% sucrose (Figure 4. 2). In total,  $2 \times 10^9$  CFU of *S. mutans* were inoculated into the system. Based on sampling of individual steel biostud, the total load on the 12 discs at the end of the experiment was estimated to be  $7.29 \times 10^7$  cells in the absence of sucrose or  $3.10 \times 10^8$  cells in the presence of sucrose. Therefore, in each case, it was not clear whether *S. mutans* had grown in the system.

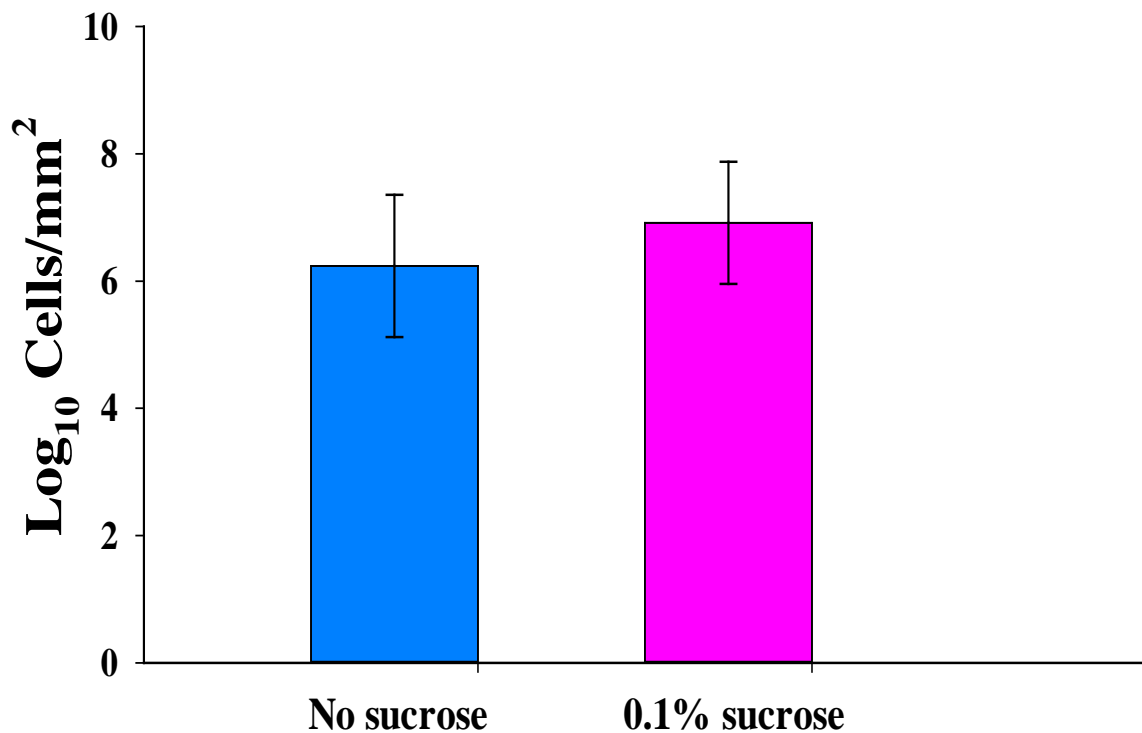

Figure 4. 2 Quantitative PCR determination of *S. mutans* UA159 in monospecies biofilms developed in the MRD without and with 0.1% sucrose for 24 h. Bars represent the mean of three independent MRD runs and SDs are shown. The density of *S. mutans* UA159 was increased with 0.1% sucrose, but not significantly ( $p > 0.05$ ).

#### 4.2.3 SEM of *S. mutans* UA159 monospecies biofilms

*S. mutans* UA159 monospecies biofilms were visualised by SEM. Chains of *S. mutans* UA159 cocci were clearly visible in biofilms cultured with and without 0.1% sucrose (Figure 4. 3). Biofilm matrix substances appeared more clearly in *S. mutans* UA159 monospecies biofilms with 0.1% sucrose (Figure 4. 3b) in comparison to without sucrose (Figure 4. 3a).

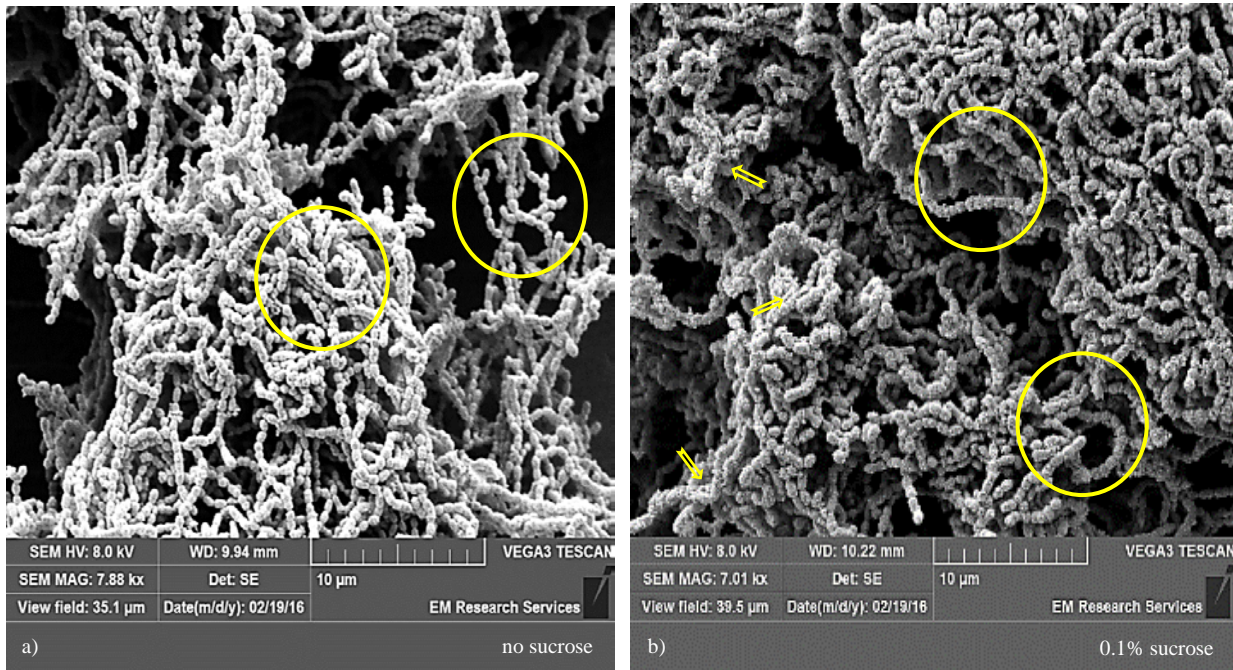

Figure 4. 3 SEM images of *S. mutans* UA159 in monospecies biofilms without sucrose (a), and with 0.1% sucrose (b). Chains of cocci (yellow circles) in biofilms with 0.1% sucrose (b), and without sucrose (a). In the presence of 0.1% sucrose, cells appeared to be covered in a granular material (short notched arrows), which is likely to be exopolysaccharide that has been dehydrated during SEM preparation.

#### 4.2.4 Visualisation of EPS in *S. mutans* UA159 monospecies biofilms using fluorescent dye and CLSM

The EPS of *S. mutans* UA159 monospecies biofilm was visualised in biofilms using CalcoFluor White to evaluate more clearly the effect of sucrose on the EPS in the biofilm matrix. The CLSM images clearly showed enhanced EPS in biofilms cultured with sucrose than without (Figure 4. 4c, and d). Labelling of bacterial cells with PI indicated that there were more cells in 24 h biofilms with 0.1% sucrose when compared with these without sucrose (Figure 4. 4a, and b).

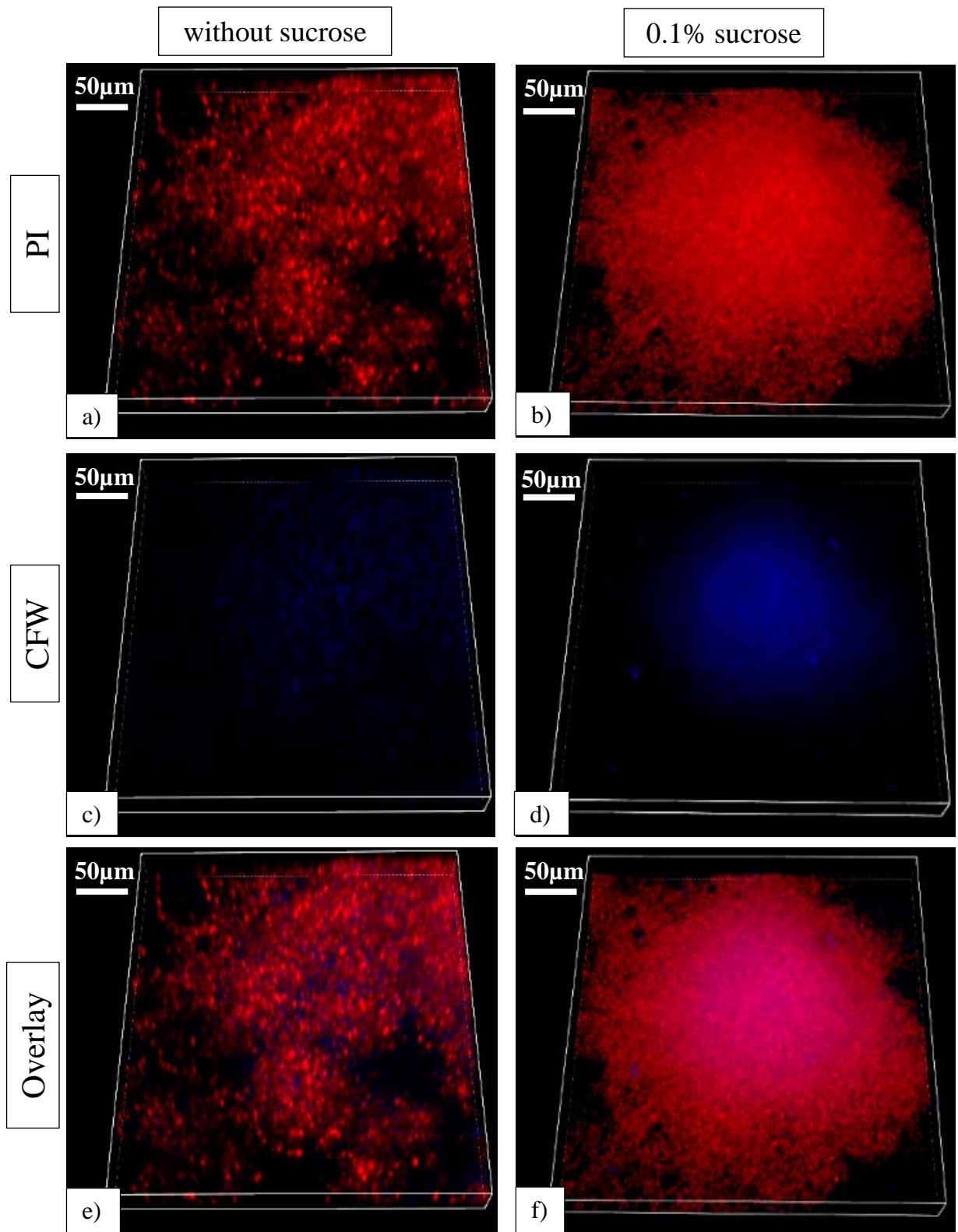

Figure 4. 4 CLSM images of monospecies *S. mutans* UA159 to show the exopolysaccharide (EPS) substance in biofilm matrix. The left panels represent the biofilm sample without sucrose, while the right panels represent the sample with 0.1% sucrose. Images (a) and (b) show bacterial cells stained with PI (Red); (c), and (d) show exopolysaccharide stained with CalcoFluor White (CFW) (Blue), and (e, f) are overlays. The scale bar is 50µm.

### 4.3 Incorporation the *S. mutans* UA159 within the Preformed Early

#### Coloniser Mixed Species Biofilm

*S. mutans* UA159 was inoculated into preformed early coloniser mixed species biofilms to assess its ability to integrate into the biofilm. The MRD were run firstly for 24 h allowing the development of early coloniser mixed biofilms, as described in Section 3.3. The preformed biofilms were then challenged with *S. mutans* UA159, and the MRD were run for an additional 24 h to permit the establishment of mixed species biofilms.

#### 4.3.1 Quantification of different species in biofilms following challenge with *S. mutans* UA159

After *S. mutans* had been allowed to grow for 24 h, biofilms were harvested and each species was quantified by qPCR using specific primers (see Table 2. 2). The addition of 0.1% sucrose did not affect growth of any species, including *S. mutans* UA159, within the mixed species biofilms (Figure 4. 5). The total CFU of *S. mutans* inoculated into the system was  $2 \times 10^9$ . By sampling individual steel biostud, the estimated total load on the 12 discs at the end of the experiment was  $1.04 \times 10^7$  cells in the absence of sucrose or  $6.71 \times 10^6$  cells in the presence of sucrose.

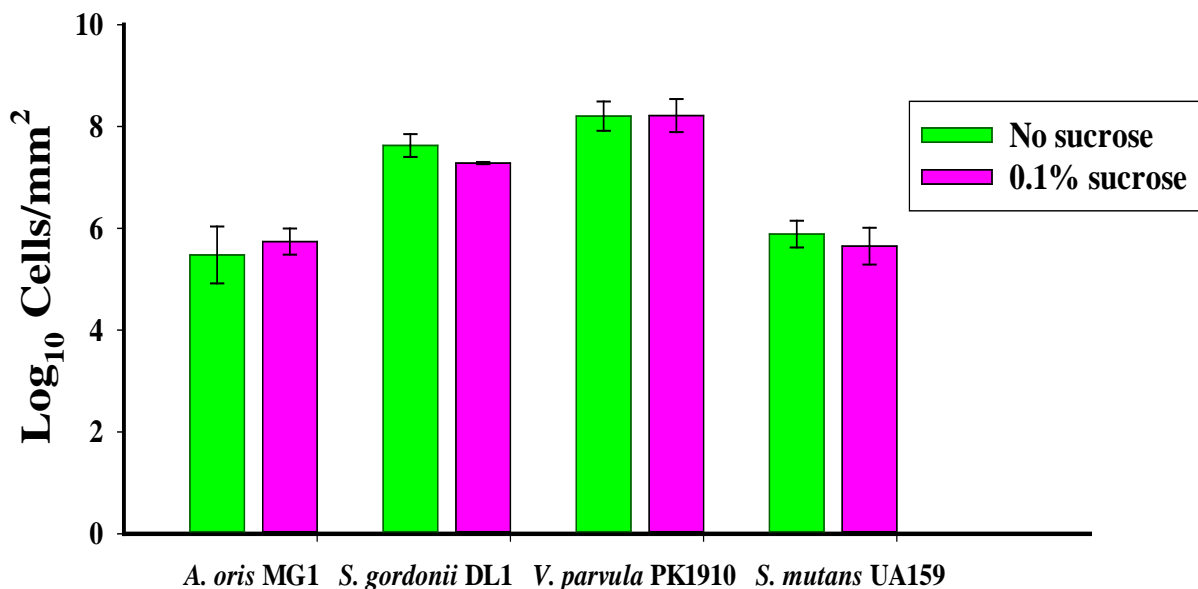

Figure 4. 5 Quantification of *S. mutans* UA159 cells with other three pioneer species in mixed species biofilms by qPCR. Mean  $\pm$  SD of three independent experiments are shown. There was no significant difference between counts of any species in biofilms without or with 0.1 sucrose ( $p > 0.05$ ).



The presence of *S. mutans* UA159 did not affect the primary colonisers. This was demonstrated by comparing the qPCR of the early coloniser mixed species biofilms described in Section 3.3.2, with the qPCR of mixed species biofilm inoculated with *S. mutans* UA159 (Figure 4. 6).

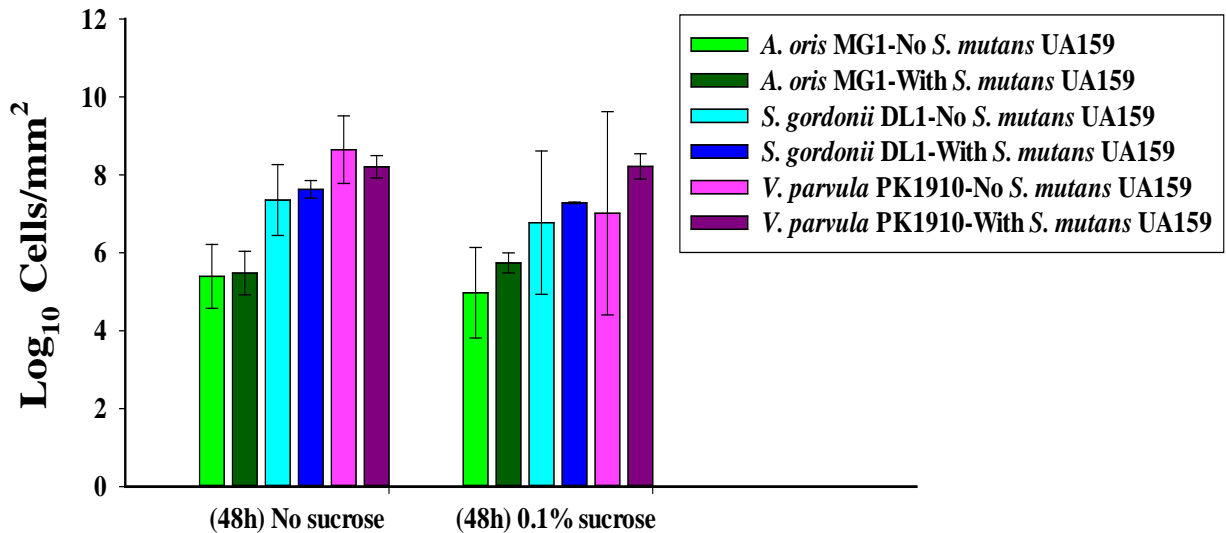

Figure 4. 6 Comparison of levels of early colonisers in biofilms without or with *S. mutans* UA159 present, with and without sucrose. Numbers of each species were determined by qPCR. Bars represent the mean  $\pm$  SD of three independent MRD runs. The *S. mutans* UA159 did not significantly impact levels of any other species within the biofilms ( $p > 0.05$ ).

#### 4.3.2 Comparison between the levels of *S. mutans* UA159 in monospecies and mixed species biofilms

The numbers of *S. mutans* UA159 cells in monospecies, and in mixed species biofilm with and without 0.1% sucrose, were compared to assess differences in the growth of *S. mutans* UA159 (Figure 4. 7). Although levels of *S. mutans* appeared higher in monospecies than in mixed species biofilms in the presence of sucrose, the difference was not significant ( $p > 0.05$ ).

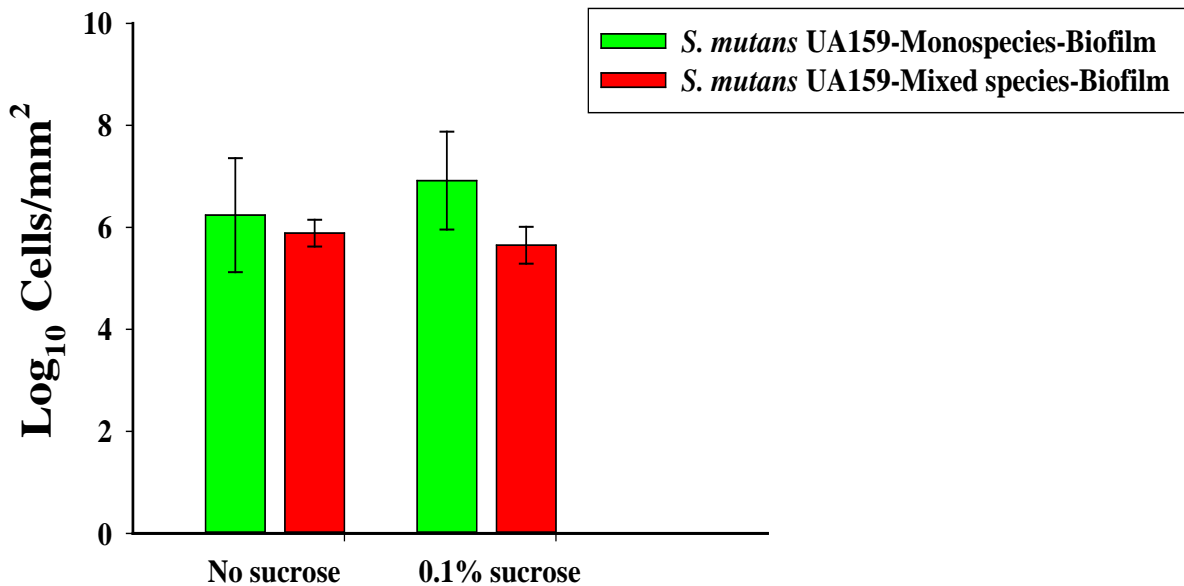

Figure 4. 7 Comparison of *S.mutans* UA159 cells within mixed species and monospecies biofilms without and with 0.1% sucrose. Mean  $\pm$  SD from three independent experiments is shown. There was no significant difference between *S.mutans* UA159 counts in mixed species versus monospecies biofilms in the presence or absence of sucrose ( $p>0.05$ ).

#### 4.3.3 FISH labelling of *S. mutans* UA159

To label *S. mutans* UA159 specifically in mixed species biofilms, a FISH assay was developed. The specificity of the FISH probe for *S. mutans* was assessed via planktonically grown cells of *A. oris* MG1, *S. gordonii* DL1, *V. parvula* PK1910, and *S. mutans* UA159, which were processed with Universal and *S. mutans* FISH-PNA probes as described in Section 2.5.1. The labelled samples were prepared for epifluorescent microscope examination and imaging (as in Section 2.6.2). The epifluorescent microscope images results (Figure 4. 8) showed that the *S. mutans* probe (Figure 4. 8 right panels) specifically labelled the *S. mutans* UA159 as intended (Figure 4. 8h). In contrast, the universal probe (Figure 4. 8 left panels) fluorescent labelling showed all four species (Figure 4. 8a, c, e, and g respectively).

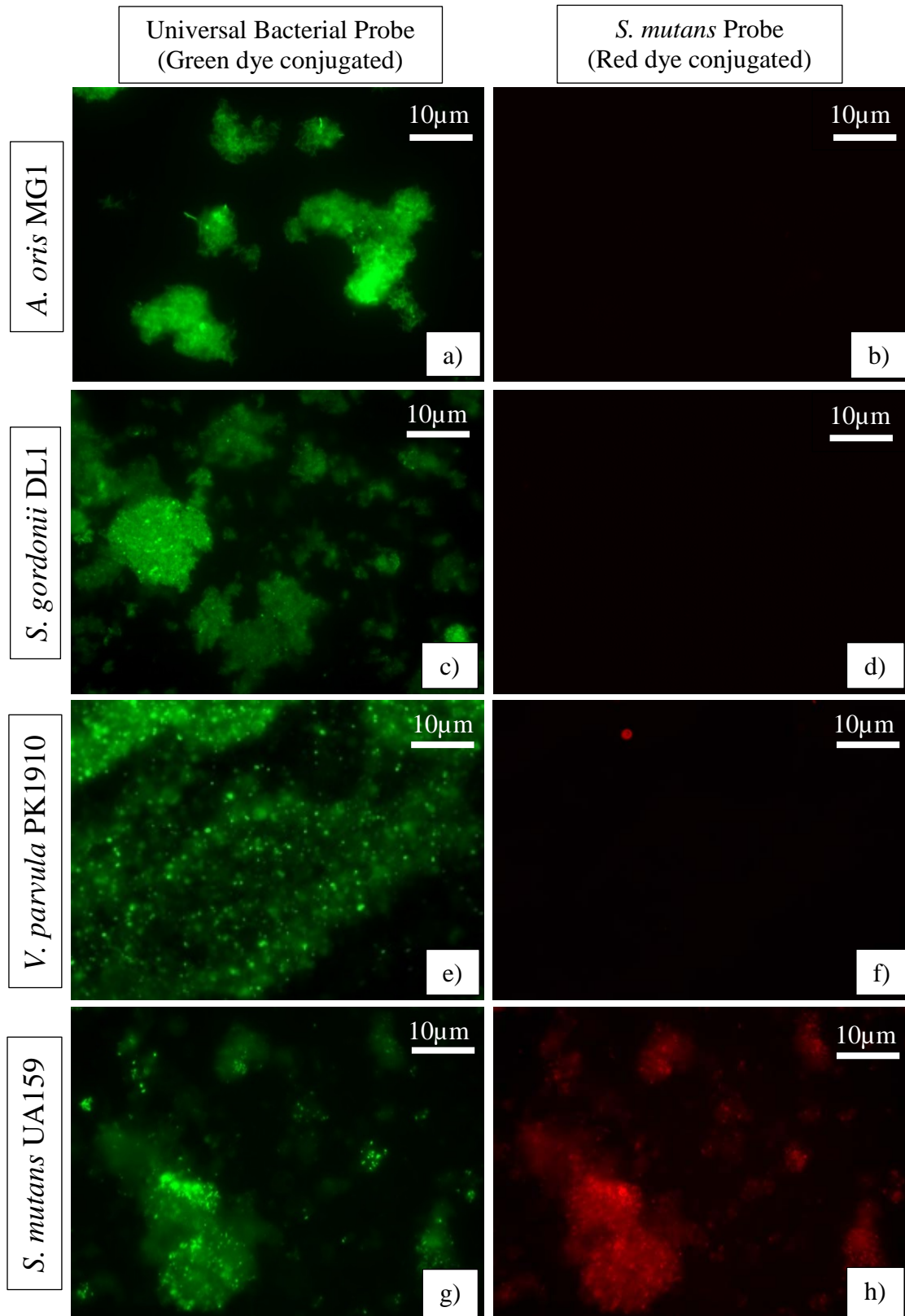

Figure 4. 8 Epifluorescence Microscope images of the bacterial cells labelled by FISH. PNA probes (Universal probe-left panels), and (*S. mutans* probe-right panels) were used to label the monocultures of each species. *A. oris* MG1 (a, b), *S. gordonii* DL1 (c, d), *V. parvula* PK1910 (e, f), and *S. mutans* UA159 (g, h). The images show that the Universal bacterial probe labelled the four species, while the *S. mutans* probe labelled only *S. mutans* UA159. The scale bar is 10µm.

### ***Detection of S. mutans UA159 within mixed species biofilms by FISH***

Mixed species biofilms challenged with *S. mutans* UA159 were processed with FISH labelling to detect *S. mutans* within the biofilms. The biofilms were collected before and after inoculation, and treated by Universal and *S. mutans* FISH PNA probes as described in Section 2.5.1. The treated biofilm was prepared for CLSM examination and imaging as described in Section 2.6.3. The CLSM image results (Figure 4. 9) demonstrated the biofilm samples before (Figure 4. 9 left panels), and after (Figure 4. 9 right panels) inoculation of *S. mutans* UA159. Fluorescent detection of FISH probes confirmed that the *S. mutans* UA159 was present in the biofilms (Figure 4. 9d, and g).

The images of biofilm sections (Figure 4. 10) show the biofilms before *S. mutans* inoculation. Labelling with both FISH probes showed only the Universal probe detection (Figure 4. 10a), in comparison to the absence of any detection with *S. mutans* probe (Figure 4. 10b). In contrast, images of biofilm sections (Figure 4. 11) illustrate the biofilms after *S. mutans* UA159 challenging. The processing of biofilms using both FISH probes showed clear incorporation of the *S. mutans* UA159 across the biofilm, and fluorescent labelling was detected from *S. mutans* probe (Figure 4. 11b).

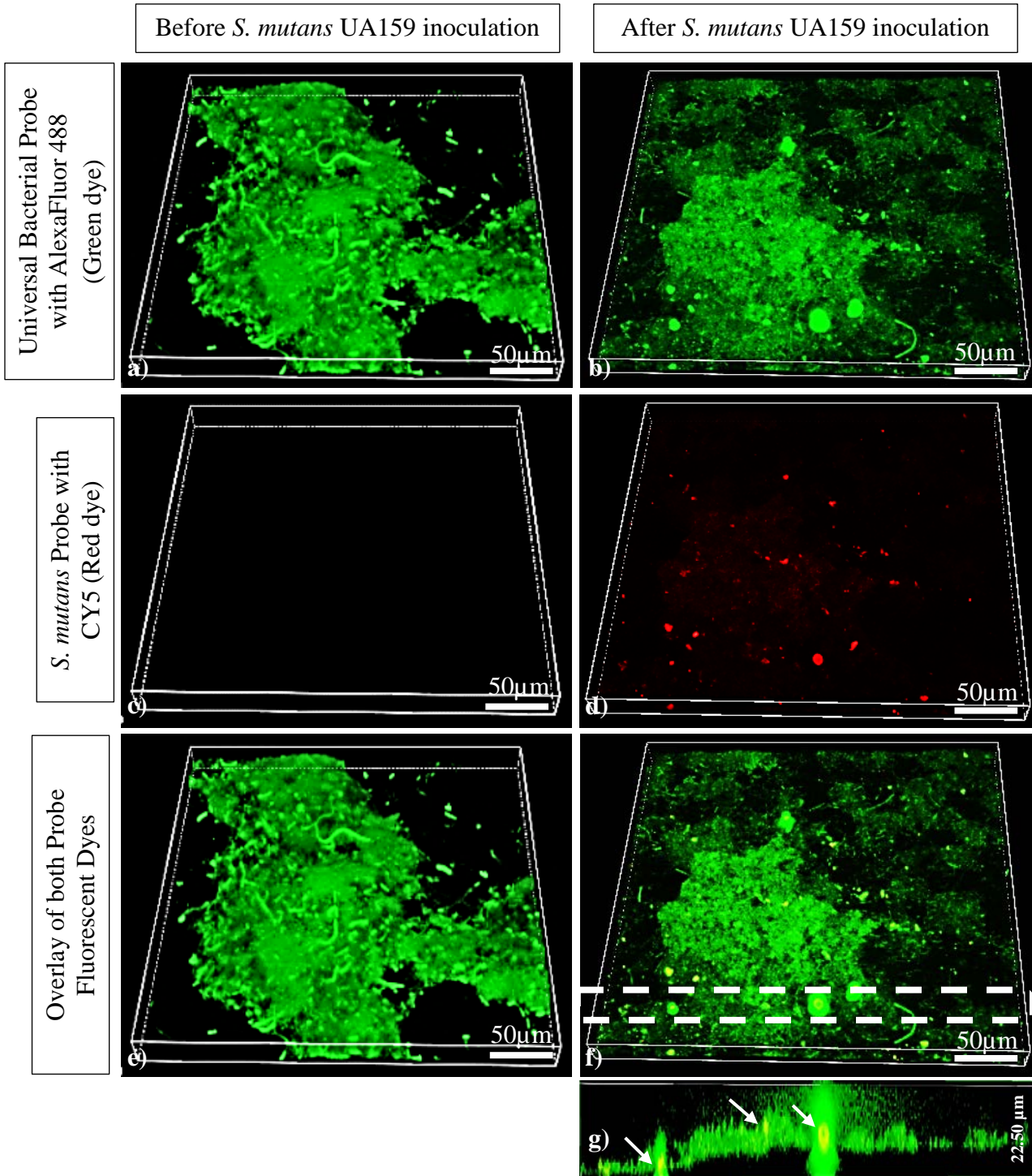

Figure 4. 9 CLSM images of mixed species biofilms before (left panels), and after (right panels) inoculation of *S. mutans* UA159. A PNA probe was used to detect the *S. mutans* UA159 within the mixed species biofilms by FISH. The universal bacterial probe (AlexaFluor 488 – in green) detected many bacterial cells within mixed species biofilms (a, b). The *S. mutans* probe (CY5 – in red) detected the *S. mutans* UA159 cells only in biofilms after inoculation (d). The images (e, f) show the overlay of both fluorescent dyes. A single vertical slice through the biofilm, the dashed rectangle in panel (f), containing *S. mutans* (white arrows) is shown in panel (g). The scale bar is 50µm.

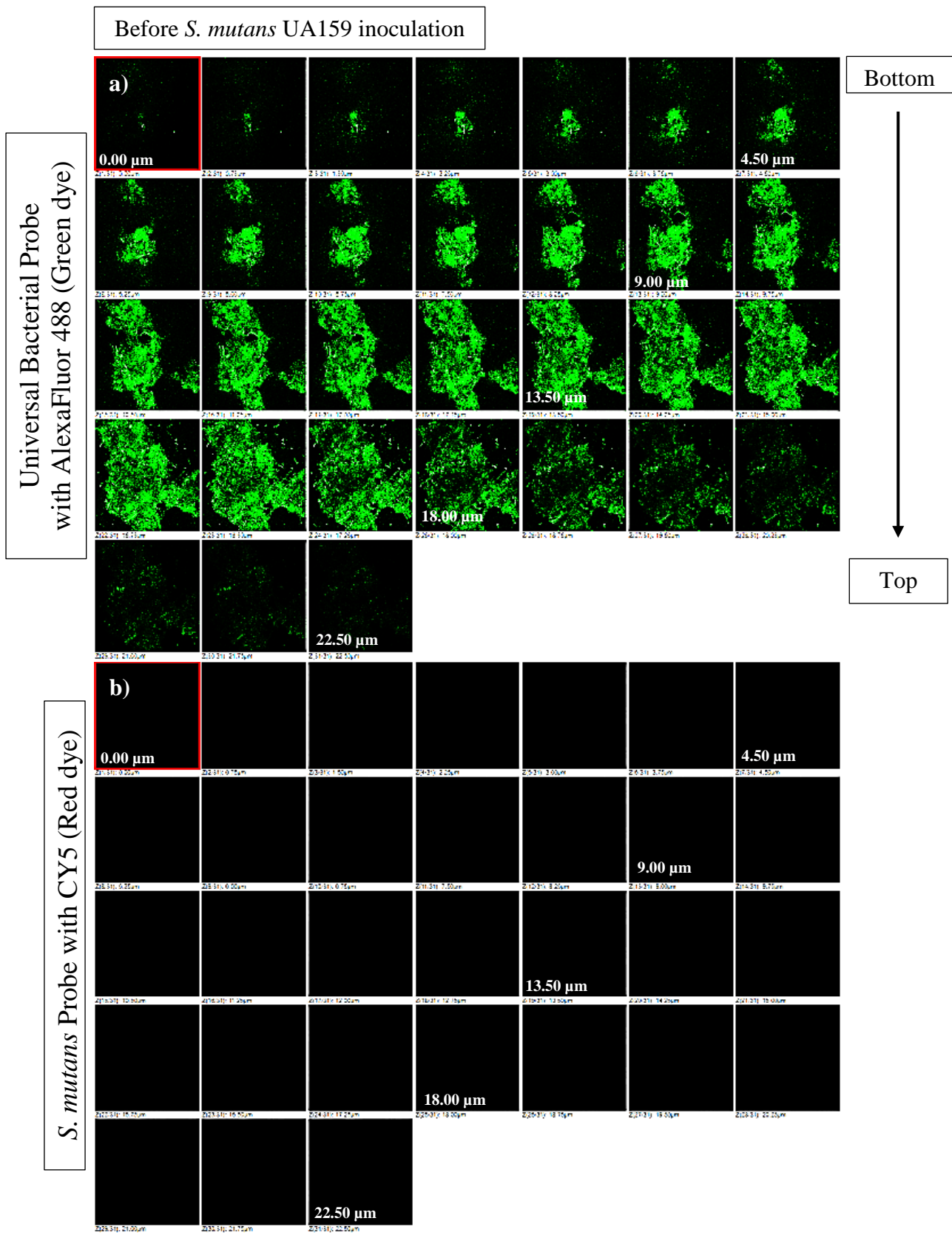

Figure 4. 10 Sectioning CLSM imaging of FISH-labelled biofilms before being challenged with *S. mutans* UA159. Only the green dye conjugated with Universal probe detected bacteria. There was no signal from the *S. mutans* probe conjugated with red dye, indicating an absence of *S. mutans*.

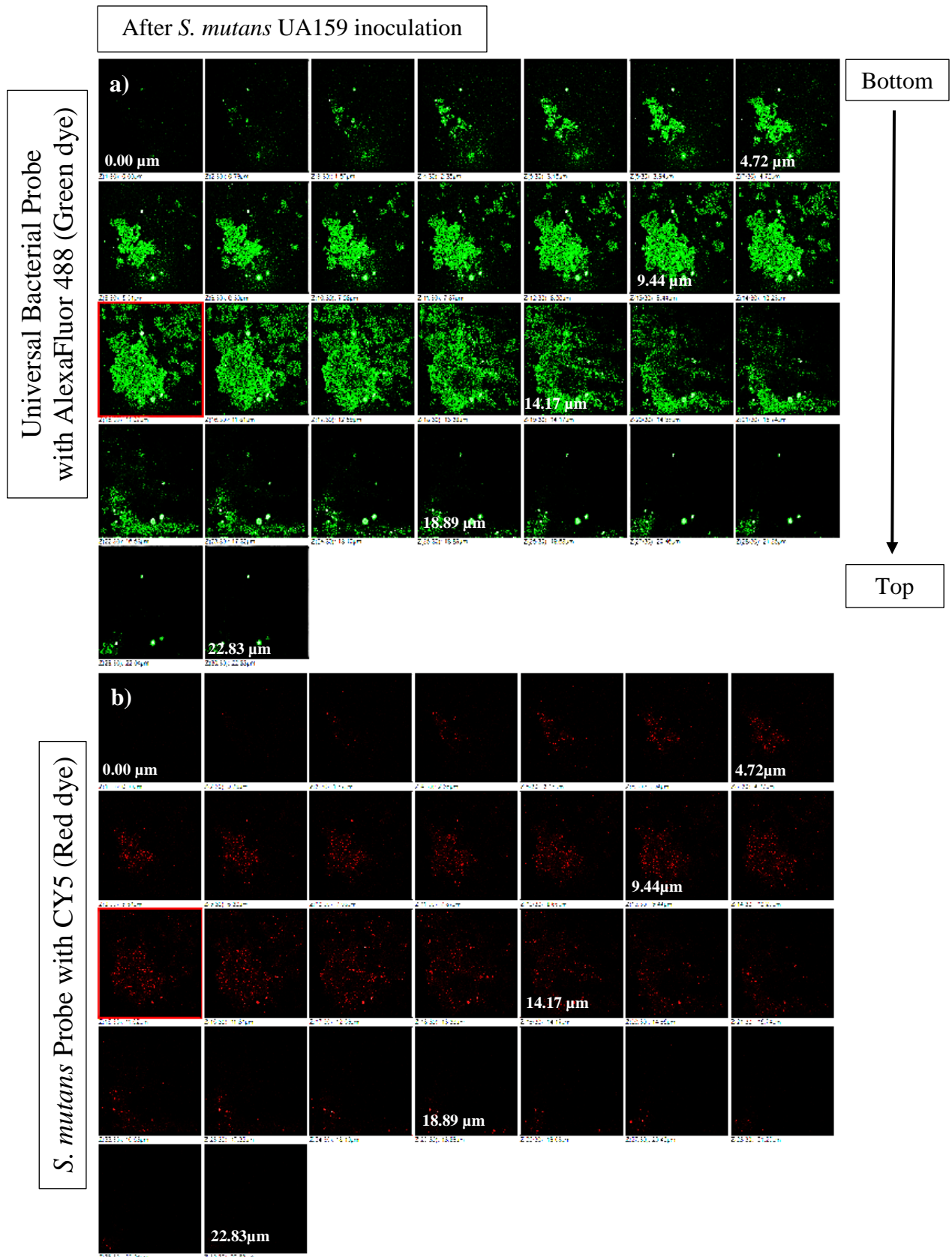

Figure 4. 11 Sectioning CLSM imaging of FISH labelled biofilms after *S. mutans* UA159 challenging. *S. mutans* UA159 was visualised throughout the biofilm sections, as shown by the red dye (d).

#### **4.3.4 SEM of mixed species biofilms**

Scanning Electron Microscope examination was undertaken for mixed species biofilms before and after inoculation of *S. mutans* UA159 to visualise the structure of the biofilm and assess if the structure was affected by *S. mutans* UA159 with and without the presence of 0.1% sucrose. The SEM images (Figure 4. 12) show the appearance of chains of cocci in both of 0.1% sucrose samples before and after *S. mutans* UA159 inoculation (Figure 4. 12b, and d). The biofilm matrix is represented by the presence of threads and granules. More matrix substances were apparent after *S. mutans* inoculation in both biofilms with and without sucrose (Figure 4. 12c, and d), compared with biofilms before *S. mutans* inoculation (Figure 4. 12a, and b). There was variation in the appearance of biofilms matrix substances with and without sucrose in biofilms challenged with *S. mutans*. Granular structures predominated in the biofilm matrix substance in the biofilm with sucrose (Figure 4. 12d), while in that without sucrose the predominant appearance of biofilm matrix substances was thread-like structures (Figure 4. 12c).



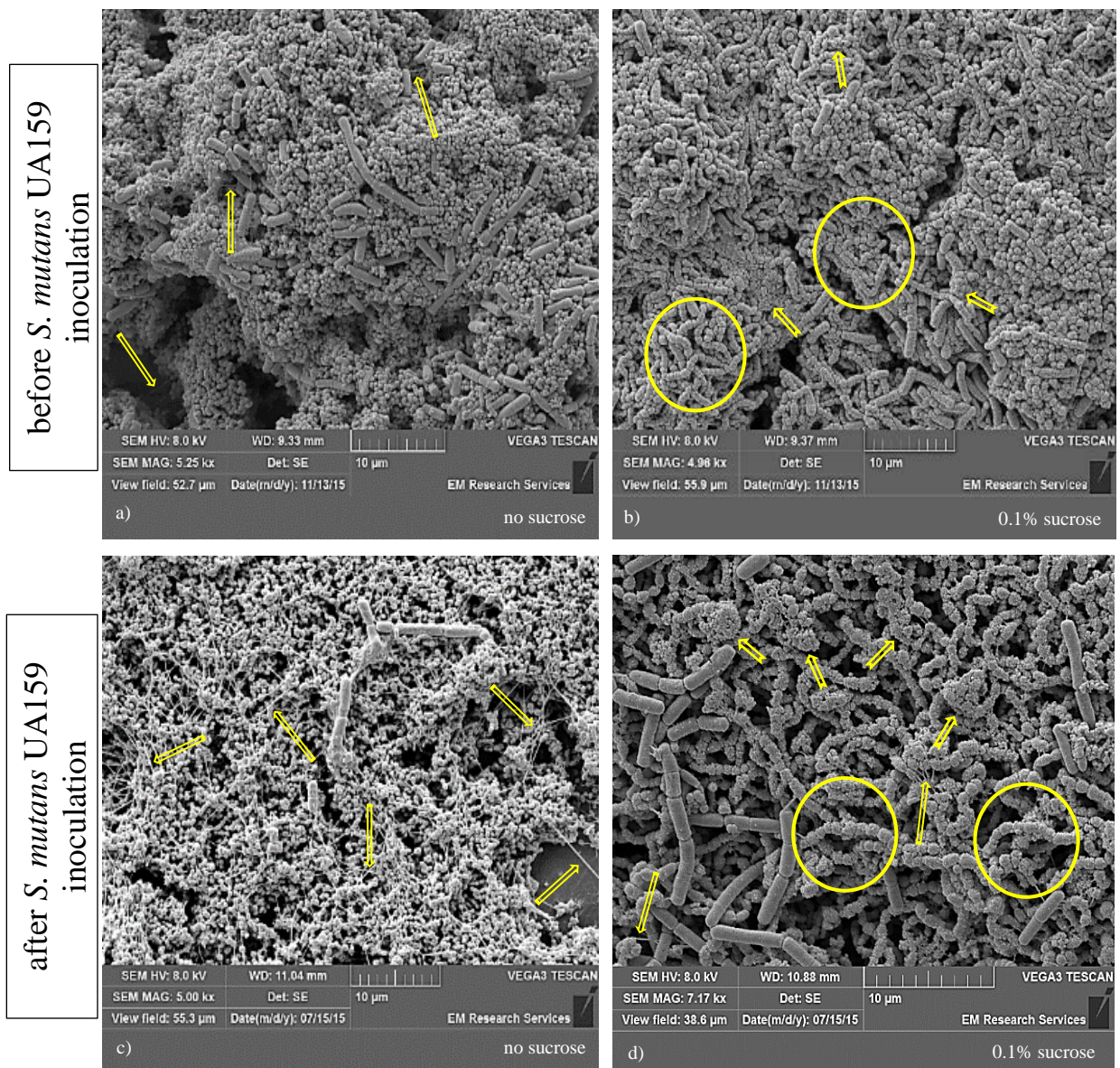

Figure 4. 12 SEM images of mixed species biofilms before (a, b), and after (c, d) inoculation of *S. mutans* UA159. The left panels represent mixed species biofilms without sucrose, while the right panels represent biofilms with 0.1% sucrose. Chains of cocci (yellow circles) tended to be more predominant in the presence of sucrose. Biofilm matrix substances were distributed between the bacterial cells either as thread shapes (long striped arrows), or as granules (short notched arrows). Changes appeared in the matrix substances after the inoculation of *S. mutans* UA159. In particular, with sucrose there was more granular material observed (compare b with d). Without sucrose, an increase in thread-like structures was seen (comparing a with c).

#### 4.4 Discussion

*S. mutans* was able to grow and establish monoculture biofilms after 24 h in both the absence and presence of 0.1% sucrose. Although the qPCR method used did not assess viability of cells, in monoculture *S. mutans* tends to remain viable in biofilms over 24 h periods (Decker *et al.*, 2014). Earlier studies have shown that *S. mutans* adherence and colonisation on tooth surfaces is sucrose-independent (Houte *et al.*, 1976; Guggenheim *et al.*, 2001). *S. mutans* can use cell surface proteins such as Ag I/II to adhere to glycoprotein receptors in the acquired salivary pellicle on tooth surface for sucrose-independent adhesion (Sullan *et al.*, 2015). However, the presence of sucrose has been shown to be involved in bacterial attachment too, thus affecting the subsequent development of biofilms. For example, under static growth conditions *S. mutans* was only able to establish a biofilm in the presence of sucrose, whilst no biofilm was observed without sucrose (Shumi *et al.*, 2010). A similar observation was shown when growing *S. mutans* using a flow system and glass beads as the biofilm substrate. The sucrose was also required to aid bacterial cells attachment and establish a biofilm (Shumi *et al.*, 2010). In this study, a flow system was also used to establish biofilms. A relatively low concentration of sucrose (0.1%) was employed here and it is possible that increased biofilm formation would have been observed with higher concentrations. In addition, the stainless steel surface used as substrate for biofilm establishment was different from previous studies, and this may also have affected biofilm growth.

When *S. mutans* was inoculated into preformed early colonisers mixed species biofilms, it was able to colonise and grow. Although the numbers of *S. mutans* cells were approximately ten-fold lower in mixed-species biofilms than in monoculture biofilms in the presence of 0.1% sucrose, differences were not statistically significant. There was also approximately a two-fold reduction in *S. mutans* in mixed species compared with monospecies biofilms when sucrose absence, but these differences were also not statistically significant. Therefore, overall it appears that *S. mutans* UA159 was able to colonise pre-formed biofilms well and integrate with the existing species. A variety of synergistic and antagonistic relationships have been described between the early colonisers used here and *S. mutans*. For example, *S. gordonii* has the ability to inhibit the growth of *S. mutans* by producing hydrogen peroxide (H<sub>2</sub>O<sub>2</sub>) (Zheng *et al.*, 2011; Zeng *et al.*, 2012). To overcome such interspecies competition, *S. mutans* can excrete bacteriocins in protection (Kreth *et al.*, 2005b; Kreth *et al.*, 2008). *S. gordonii* can also release DNA, which in turn may activate *S. mutans* competence system, and increase bacteriocin production. Furthermore, the presence of *V. parvula* in mixed species with *S.*

*mutans* and *S. gordonii* had a great effect on the competitive relationship between these two antagonist species. *S. mutans* showed better growth in mixed species biofilm with *S. gordonii* and when *V. parvula* was present, unlike its growth in dual species with *S. gordonii*, which was less (Liu *et al.*, 2011). *Veillonella* spp. are often found in association with *S. mutans* and benefit *S. mutans* by utilising the lactic acid produced during *S. mutans* metabolism (Kara *et al.*, 2007; Aas *et al.*, 2008). Overall, in the biofilm model here, the antagonistic and synergistic interactions appeared to balance out since *S. mutans* was able to colonise a pre-existing biofilm just as well as a saliva-coated surface.

Challenging the preformed mixed species biofilms with *S. mutans* UA159 did not appear to significantly affect levels of the pioneer species, with the possible exception that a slight (but not significant) increase was observed in *V. parvula* numbers following *S. mutans* challenge in the presence of 0.1% sucrose. It should be noted that the model was not specifically set up to investigate competition. In particular, the use of qPCR to enumerate biomass would not necessarily have detected cell death unless the DNA template was degraded. Nevertheless, observations that *Veillonella* numbers were slightly (though not statistically significantly) increased following inoculation with *S. mutans* are consistent with previously published work. For example, epidemiological studies to identify different bacterial species by sampling human carious lesions has shown that a high number of *Veillonella* is associated with high a number of *S. mutans* (Aas *et al.*, 2008). In addition, higher acid production was identified in plaque samples containing both species rather than just one (Noorda *et al.*, 1988). The metabolic relationship between *S. mutans* and *V. parvula* will potentially allow mutual growth in biofilm development (Kara *et al.*, 2007). The observation that growth of *Veillonella* was only slightly, if at all, stimulated by *S. mutans* may either be due to a low concentration of added sucrose, where the lactate produced was insufficient to support more *Veillonella* growth, or because *Veillonella* was able to obtain enough lactate from other pioneer species in the preformed biofilms used in our system.

In *S. mutans* monoculture, there was evidence that the matrix was affected by the addition of sucrose. Specifically, there was clear increased matrix production and the appearance of granular materials with 0.1% sucrose than without, possibly because *S. mutans* produces glucans and fructans from sucrose. *S. mutans* can metabolise the sucrose via their exoenzymes Gtfs into the monosaccharides fructose and glucose, and at the same time the glucose can be polymerised by these enzymes to form glucans (Banas and Vickerman, 2003). Both of these polysaccharides are very important for the involvement of *S. mutans* in developing a biofilm

community (Biswas and Biswas, 2005; Takahashi and Nyvad, 2008). When *S. mutans* was grown in a flow system using different sucrose concentrations from zero to 1 mM, no EPS was detected with sucrose absent, and the attached cells were able to produce detectable EPS starting from 0.01 mM sucrose, and the amount increased when the sucrose concentration increased (Shumi *et al.*, 2010). In addition, the presence of sucrose greatly enhanced the ability of *S. mutans* bacterial cells to form biofilm, as it is important for their attachment and production of different polysaccharide polymers. In our study, the added sucrose was 0.1%, which is approximately 2.9 mM; thus, the produced EPS in biofilm with sucrose addition was clearly detectable in comparison to biofilm with no sucrose, as the concentration of added sucrose here was higher to that previously mentioned. The presence of exopolysaccharide was confirmed using CalcoFluor White, which specifically stains polysaccharides (Maeda and Ishida, 1967). This dye has also been used to stain *S. sobrinus*  $\alpha$ -(1,3) linked mutan, and *S. oralis* and *S. sobrinus*  $\alpha$ - (1,6) linked dextran in their biofilm matrix (Thurnheer *et al.*, 2004).

In mixed species biofilms, the recognised effect of *S. mutans* when challenging preformed biofilms was also shown to be in the appearance of biofilm matrix structures. Accumulated granular structures on cell surfaces were demonstrated in the biofilm with sucrose addition after *S. mutans* inoculation, which appeared to be EPS. The synthesis of EPS, as one important biofilm matrix structure, can be greatly influenced when *S. mutans* are involved in a dental biofilm community, and especially when sucrose is also present (Koo *et al.*, 2010b). *S. mutans* is particularly adept at producing glucans and fructans from sucrose since it has four different enzymes that can form more EPS in biofilm matrix (Loesche, 1986; Leme *et al.*, 2006), as previously mentioned.

In addition, thread-like matrix structures were also shown to be scattered among bacterial cells in the biofilms without sucrose addition after the *S. mutans* challenge. These structures may be non-sucrose dependent matrix substances, since they appeared to increase in biofilms cultured without sucrose. Extracellular DNA (eDNA) is non-sucrose dependent and another major component of biofilm matrix structure that has been shown to be produced by *S. mutans*, in addition to EPS (Whitchurch *et al.*, 2002). *S. mutans* competence-stimulating/ inducing peptides CSP/XIP signalling can induce cell death, resulting in eDNA synthesis and significantly influencing biofilm establishment (Petersen *et al.*, 2005; Perry *et al.*, 2009; Wenderska *et al.*, 2012). In addition to cell lysis, *S. mutans* can produce eDNA by another pathway such as membrane vesicles, and protein secretion and membrane insertion pathway (Liao *et al.*, 2014). The eDNA is considered a useful constituent of *S. mutans* biofilm, and has

an important role in biofilm formation, maturation, and stability, both with and without sucrose (Petersen *et al.*, 2005; Klein *et al.*, 2010). However, further studies will be required to characterise the nature of the polymer in more detail.

Using two different FISH probes, *S. mutans* was directly observed within the mixed-species biofilm community. When reviewing the biofilm sections, the integrated *S. mutans* appeared as several clumps of microcolonies, which were scattered separately within the biofilms mass. In the serial xy sections, and a representative xz slice of the biofilm, *S. mutans* appeared to be most abundant within the middle third of biofilm, viewed from top to bottom. It seems that following inoculation of *S. mutans*, the bacteria began to incorporate within the biofilm, moving from the top of the preformed biofilm where it was inoculated toward the bottom. These detectable *S. mutans* cells were likely to be metabolically active because of the FISH probe targeting bacterial rRNA, which rapidly degrades following cell death (Al-Ahmad *et al.*, 2009; Meagher *et al.*, 2010). In natural subgingival biofilms, it has been shown that cells at the base of biofilms were difficult to visualise by FISH, possibly because they were not metabolically active. There was gradual increase from the tooth site toward the epithelium in the fluorescent intensity of bacterial cells labelled by the same probe. Such gradual fluorescent intensity can reveal differences in the physiological activity of the bacterial cells within the biofilm (Zijngel *et al.*, 2010). In future work, the possibility of allowing a longer time for *S. mutans* growth may show more observation of the fluorescent labelling and further *S. mutans* incorporation into the base of the biofilm; it may also provide information on metabolic activity gradients throughout the biofilm.

In summary, *S. mutans* was able to establish in mixed-species biofilms just as effectively as in monospecies, and was detected by both qPCR and FISH. In both monospecies and mixed biofilms, 0.1% (w/v) sucrose led to an increase in biofilm matrix material but not in the number of *S. mutans* cells. In addition, *S. mutans* did not affect the number of cells of *S. gordonii*, *A. oris* or *V. parvula*, as determined by qPCR. It was possible that the early colonisers may have affected the viability of *S. mutans* or that *S. mutans* may have affected the early colonisers, and that the qPCR method did not detect a loss of viability. The main goal of the current project was to assess the adhesion of *S. mutans* to the biofilm. However, in future it will be interesting to quantify viable cells using an appropriate approach such as vitality qPCR. This will enable the monitoring of competition between early colonisers and *S. mutans* over longer time periods. Overall, the mixed-species MRD system appears to be a

suitable model for studying the factors that influence *S. mutans* colonisation and growth within a relevant mixed-species oral biofilm model.

## Chapter 5. Integration of *S. mutans* GS5 into Early Colonisers

### Mixed Biofilms with *S. gordonii* (Wild-Mutant)

#### 5.1 Outline and Aims

In Chapter Four, challenging preformed early colonisers mixed species biofilms with *S. mutans* UA159 showed its ability to incorporate within biofilms with and without the addition of 0.1% sucrose. In this chapter, in the first part another *S. mutans* strain (GS5) was used to challenge the same preformed biofilm and its incorporation was assessed and compared with *S. mutans* UA159 to distinguish the ability of different strains of *S. mutans* to incorporate within preformed mixed biofilms. In the second part, a mutant of *S. gordonii* (lacking the *ssnA* gene and encoding an extracellular DNase) was employed to assess the potential role of extracellular DNA in *S. mutans* colonisation.

There are many different species of *Streptococcus* found inside the oral cavity, and *S. mutans* is considered to be most strongly associated with the development of dental caries (Biswas and Biswas, 2012). *S. mutans* GS5 was originally isolated from a carious lesion of a human oral cavity, and early studies following isolation of *S. mutans* GS5 demonstrated the powerful cariogenic characteristic of this strain (Sharawy and Socransky, 1967). Their colonisation within dental biofilm was linked to the development of dental caries associated with smooth surfaces (Kuramitsu, 1973). Soon after being isolated, GS5 became much less cariogenic (Sato *et al.*, 2002). Two key genetic mutations are shown to present in GS5, and have likely been fixed since the original isolation, which may affect *S. mutans* GS5's ability to colonise, and may link to their low cariogenicity. These are *pac*, which encodes a key cell surface adhesion PAc (cell surface adhesion Antigen I/II) that mediates attachment to salivary pellicle (Murakami *et al.*, 1997), and *gbpC*, encoding glucan binding protein C, a glucan receptor that is responsible for adhesion to glucans, which can be observed in the laboratory as dextran dependent aggregation (Sato *et al.*, 2002). The *S. mutans* GS5 stock in our lab culture collection has previously been sequenced for the *pac* and *gbpC* genes and shown that both genes carry mutations and are likely to be non-functional (Shields, 2014).

*S. mutans* GS5 is of serotype *c*, the same as strain UA159, and this serotype is the most predominant of oral isolated *S. mutans* among the four serotypes (*c*, *e*, *f*, and *k*) (Nakano *et al.*, 2007). Genome sequences of different *S. mutans* strains such as GS5, UA159, NN2025, and LJ23 were shown to have a large diversity and genome rearrangement within the species (Biswas and Biswas, 2012). There is no genome inversion around the replication axis,

between UA159 and GS5, unlike GS5 and NN2025, and UA159 and NN2025 (Maruyama *et al.*, 2009; Biswas and Biswas, 2012). The core genome of *S. mutans* has been estimated to contain approximately 1,370 genes (Song *et al.*, 2013). The more variable component of the genome includes genes involved in processes such as competence regulation, bacteriocin (mutacin) production, antibiotic resistance, central carbon metabolism, and energy production.

Extracellular DNA has been shown to be important in the initial adhesion of bacterial cells such as *S. mutans*, and *Streptococcus epidermidis* 1457 to surfaces (Das *et al.*, 2010). The adhesion and bacterial aggregation can be enhanced as a result of acid-based interactions that occur when eDNA is present in the matrix of the biofilm (Das *et al.*, 2010). Extracellular DNA is abundant in many monospecies biofilms (Okshevsky and Meyer, 2015), and has also been detected in mixed species biofilms such as dental plaque (Rostami *et al.*, 2017). Extracellular DNA has been shown to interact with carbohydrates and proteins and these interactions appear to strengthen biofilm development, and stabilise the biofilm (Jennings *et al.*, 2015; Rocco *et al.*, 2017). The biochemical analysis of *Myxococcus xanthus* and *Pseudomonas aeruginosa* monospecies biofilms extracellular matrix, which are located over the cell surface and connect adjacent cells, showed that there were cross-links between exopolysaccharide and eDNA in each of these matrices due to ionic interaction. (Hu *et al.*, 2012; Jennings *et al.*, 2015).

The eDNA has been shown to be a useful constituent of the *S. mutans* biofilm, and has an important effective role in biofilm formation, maturation, and stability, in both the absence and presence of sucrose (Petersen *et al.*, 2005; Klein *et al.*, 2010). The released eDNA during the development of the biofilm can be degraded by bacterial extracellular deoxyribonuclease (DNase) enzymes (Palmer *et al.*, 2012). Certain oral bacterial species have been shown to produce extracellular DNases that are regulated by culture conditions, for example differences in oxygen tension or whether cells are cultured on solidified or in broth media. From a total of 34 screened different periodontal bacterial species strains, 27 bacterial strains were able to produce extracellular DNase (Palmer *et al.*, 2012).

As part of this study, *S. gordonii* as a key oral early coloniser was shown to have the ability to produce extracellular DNase (Palmer *et al.*, 2012). This enzyme could potentially affect other species in the biofilm and could decrease colonisation of species that require eDNA for adhesion. In another study, the DNase of *S. gordonii* was identified as the product of a gene that has been termed *ssnA*, and caused a reduction in biofilm matrix eDNA, which in turn reduced the biofilm



stability of some monospecies biofilms (Shields, 2014). The total production of eDNA and the sensitivity of biofilms to DNase differs between oral bacterial species such as *S. mutans* GS5, *A. oris* MG1, and *F. nucleatum* 25586 (Shields, 2014). *S. mutans* GS5 biofilms were particularly sensitive to the DNase. Therefore, it is hypothesised that disruption of the *ssnA* gene in *S. gordonii* will lead to a change in the ability of *S. mutans* to colonise biofilms.

On this basis, the aims of this chapter are to:

- 1- Compare the integration of *S. mutans* GS5 versus *S. mutans* UA159 within preformed early coloniser mixed species biofilms.
- 2- Investigate the influence of *S. gordonii ssnA* on the colonisation ability of *S. mutans* GS5.

The objectives are to:

- 1- Challenge preformed early colonisers mixed species biofilms with another *S. mutans* strain (GS5), and investigate the effects on bacterial cell numbers, incorporation of *S. mutans* within the biofilms, biofilm structure, and EPS in biofilm matrix.
- 2- Establish early colonisers mixed species biofilms with *S. gordonii ssnA*, in addition to other pioneer species *A. oris* MG1 and *V. parvula* PK1910, and challenge them with *S. mutans* GS5, and evaluate the effect on bacterial cell numbers, biofilm structures, and EPS in the biofilm matrix.
- 3- Assess whether the incorporation of *S. mutans* GS5 into biofilms containing *S. gordonii ssnA* is different from incorporation into biofilms containing *S. gordonii* wild-type
- 4- Visualise eDNA in the matrix of biofilm with *S. gordonii ssnA*.

## 5.2 Inoculation of *S. mutans* GS5 into Preformed Mixed Biofilms with Wild-Type

### *S. gordonii* DL1

Early coloniser mixed species biofilms containing *S. gordonii*, *A. oris* and *V. parvula* (see Chapter 3 and Chapter 4) were challenged with another *S. mutans* strain (GS5) to see how this strain incorporated within mixed biofilm in comparison to *S. mutans* UA159. The integration of *S. mutans* GS5 within the preformed biofilms was evaluated. Biofilms were established as described in Section 3.3, and the *S. mutans* GS5 was inoculated within the biofilms as described in Section 4.3.

### 5.2.1 Quantification of *S. mutans* GS5 in mixed species biofilm by qPCR

Numbers of *S. mutans* GS5 in mixed species biofilms were quantified by qPCR. The presence of 0.1% sucrose did not cause any significant difference in *S. mutans* GS5 numbers compared to the absence of sucrose (Figure 5. 1). In addition, at zero time of *S. mutans* GS5 inoculation within the biofilm with and without sucrose, the number of *S. mutans* GS5 bacterial cells was  $2 \times 10^9$ . After 24 h of inoculation within the biofilm, the number of *S. mutans* GS5 was  $1.66 \times 10^5$  in sucrose absent biofilm, and  $2.50 \times 10^5$  in biofilm with 0.1% sucrose. Considering the pioneer bacterial species of the preformed mixed biofilms, there appeared to be a slight increase in the levels of each pioneer coloniser of mixed species biofilms with sucrose. However, these differences were not statistically significant ( $p > 0.05$ ).

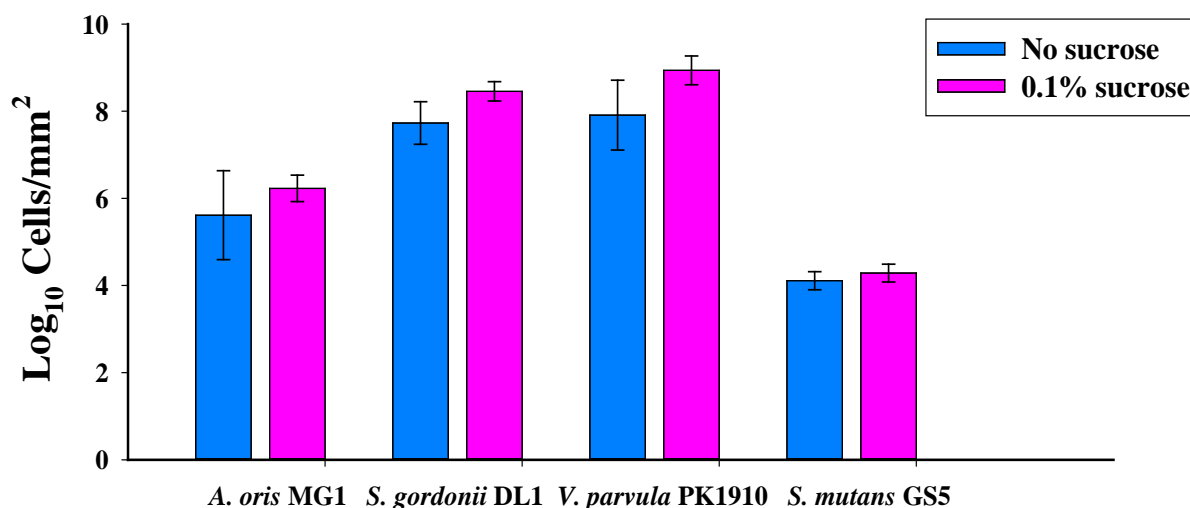

Figure 5. 1 Quantification of *S. mutans* GS5 cells and other pioneer species within mixed biofilms. Mean  $\pm$  SD from three independent experiments is shown. The number of cells showed no statistically significant differences with and without 0.1% sucrose. Quantification of other biofilms species increased minimally in 0.1% sucrose compared with no sucrose ( $p > 0.05$  in all cases).

### 5.2.2 Comparison of the quantification of *S. mutans* GS5 and UA159 in mixed species biofilm

*S. mutans* GS5 counts and previously quantified *S. mutans* UA159 counts (Section 4.3.1) were compared to evaluate how different strains of the same species integrated within preformed early coloniser mixed species biofilms. The numbers of *S. mutans* UA159 in mixed species biofilms was significantly higher ( $p < 0.05$ ) by nearly two orders of magnitude in comparison to *S. mutans* GS5 in the absence or presence of sucrose (Figure 5. 2).

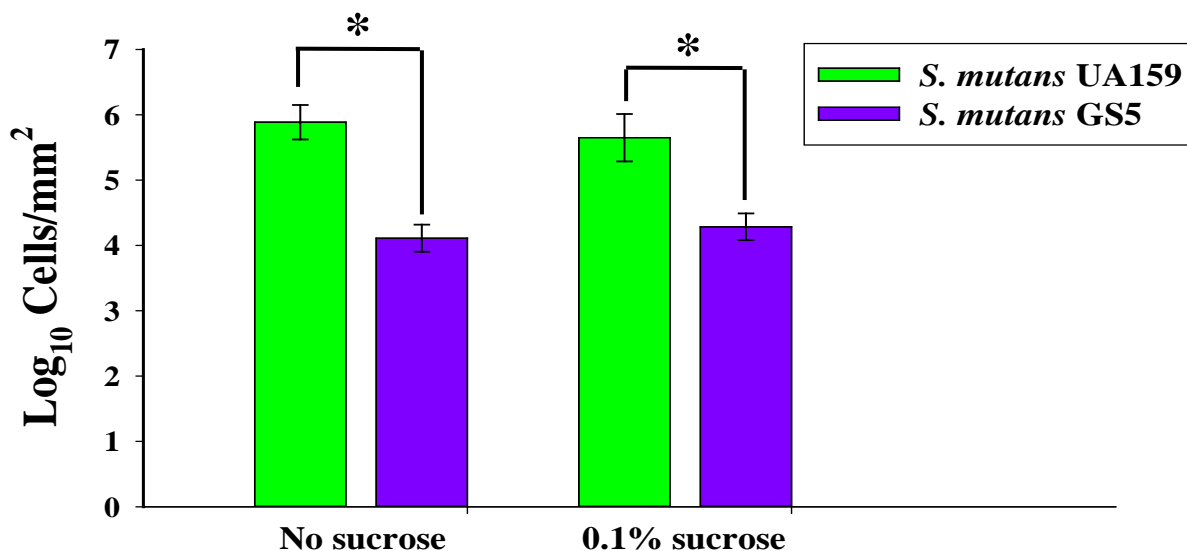

Figure 5. 2 Comparison of the quantification of *S. mutans* UA159, and *S. mutans* GS5 cells within mixed species biofilms without and with 0.1% sucrose. Bars represent mean of three independent experiments with  $\pm$  SDs. Numbers of *S. mutans* UA159 cells were higher than *S. mutans* GS5 in both biofilms. The difference was statistically significant ( $p < 0.05$ ).\*

### 5.2.3 Detection of *S. mutans* GS5 integration in mixed species biofilm by FISH

Integration of *S. mutans* GS5 within mixed species biofilms was detected by FISH labelling. Samples were gathered before and after inoculation with *S. mutans* GS5. Samples were processed with FISH PNA probes, and set for CLSM investigation, as described in Sections 2.5.1 and 2.6.3, respectively. Images (Figure 5. 3d, and g) showed the integration of *S. mutans* into the biofilms.

CLSM images of biofilm sections (Figure 5. 4) demonstrated FISH detection before inoculation of *S. mutans* GS5. Only the universal probe gave a fluorescent signal (Figure 5. 4a), while with the *S. mutans* probe there was no background red fluorescence anywhere in the biofilm (Figure 5. 4b), which confirmed the absence of *S. mutans* cells. In sectional images of biofilms after culturing *S. mutans* GS5 within the biofilms (Figure 5. 5), the *S. mutans* probe detected the integration of *S. mutans* GS5 scattered throughout the depth of the biofilm (Figure 5. 5b).

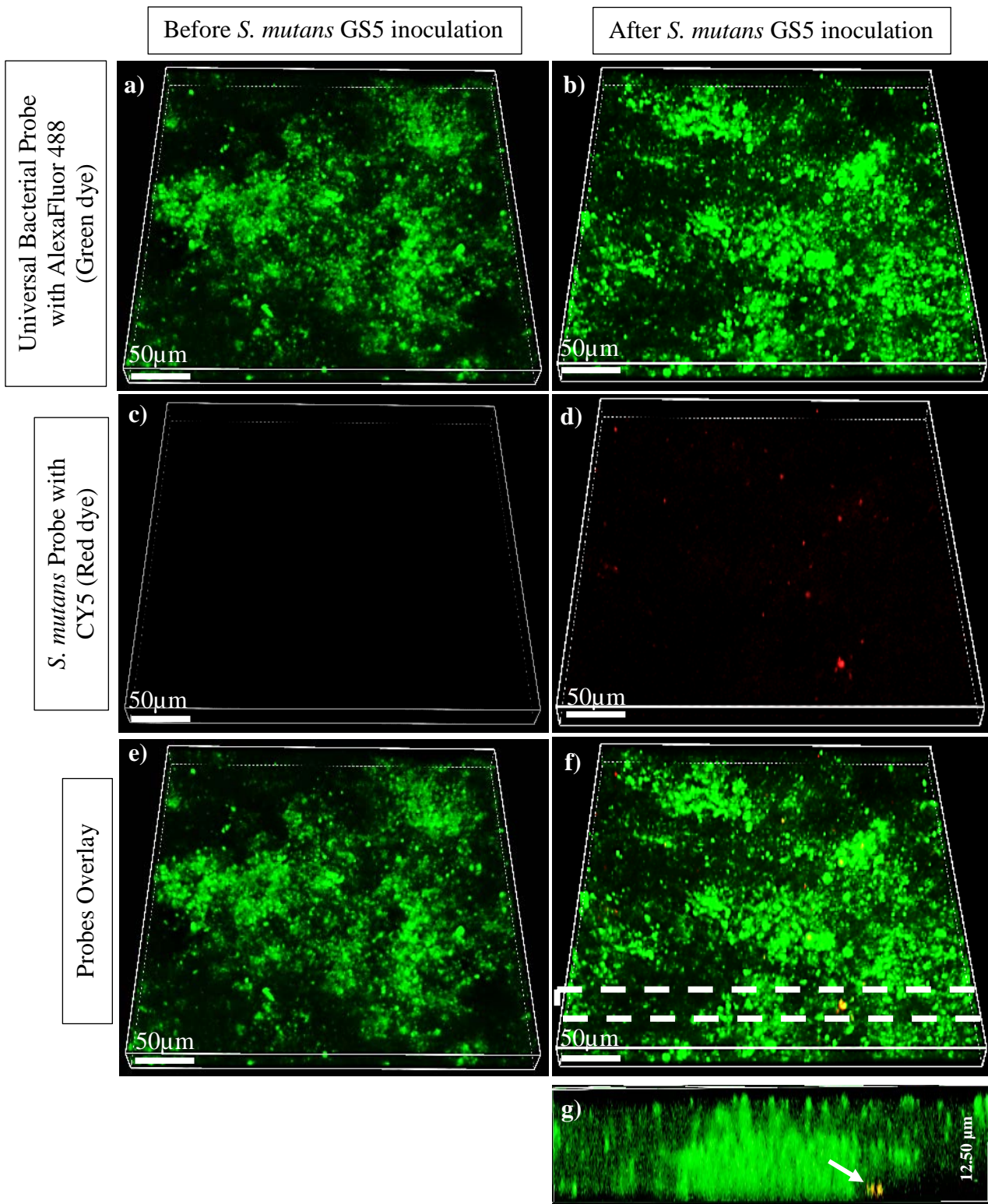

Figure 5. 3 CLSM images of mixed species biofilms before (left panels), and after (right panels) challenge with *S. mutans* GS5. All bacteria within mixed biofilms were detected by the universal bacterial probe. The *S. mutans* probe detected only the *S. mutans* GS5 cells after their inoculation within the mixed species biofilms (d). Images (e, f) show the overlay of both FISH probes. A vertical slice at the position indicated by the dashed rectangle in panel (f) is shown in (g), and *S. mutans* is indicated by the white arrow. The scale bar is 50µm.

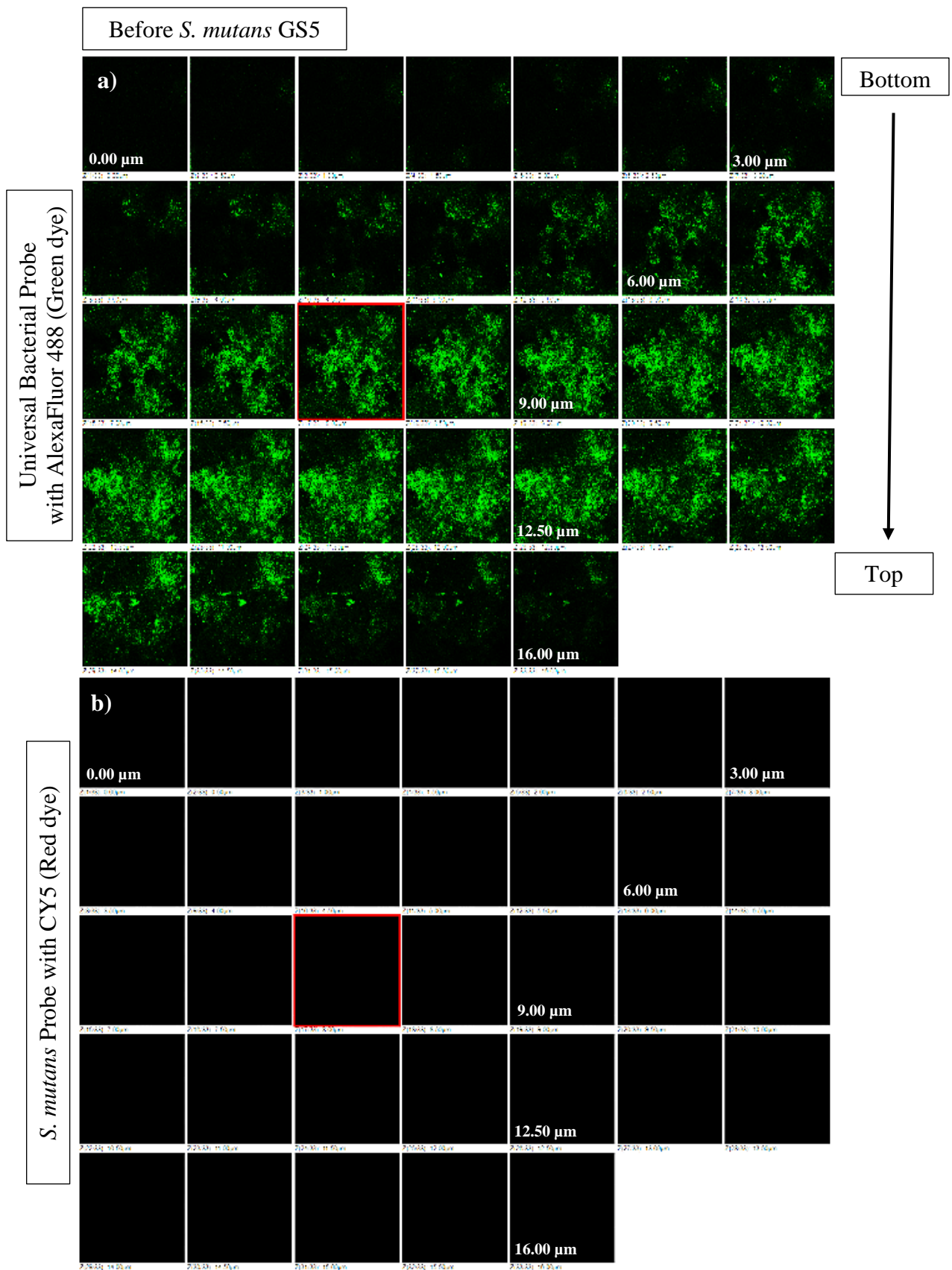

Figure 5. 4 Sectioned CLSM imaging of FISH detection biofilms before *S. mutans* GS5 inoculation. Only the universal probe showed green fluorescent signalling, while no red signalling was detected from the *S. mutans* probe (d).

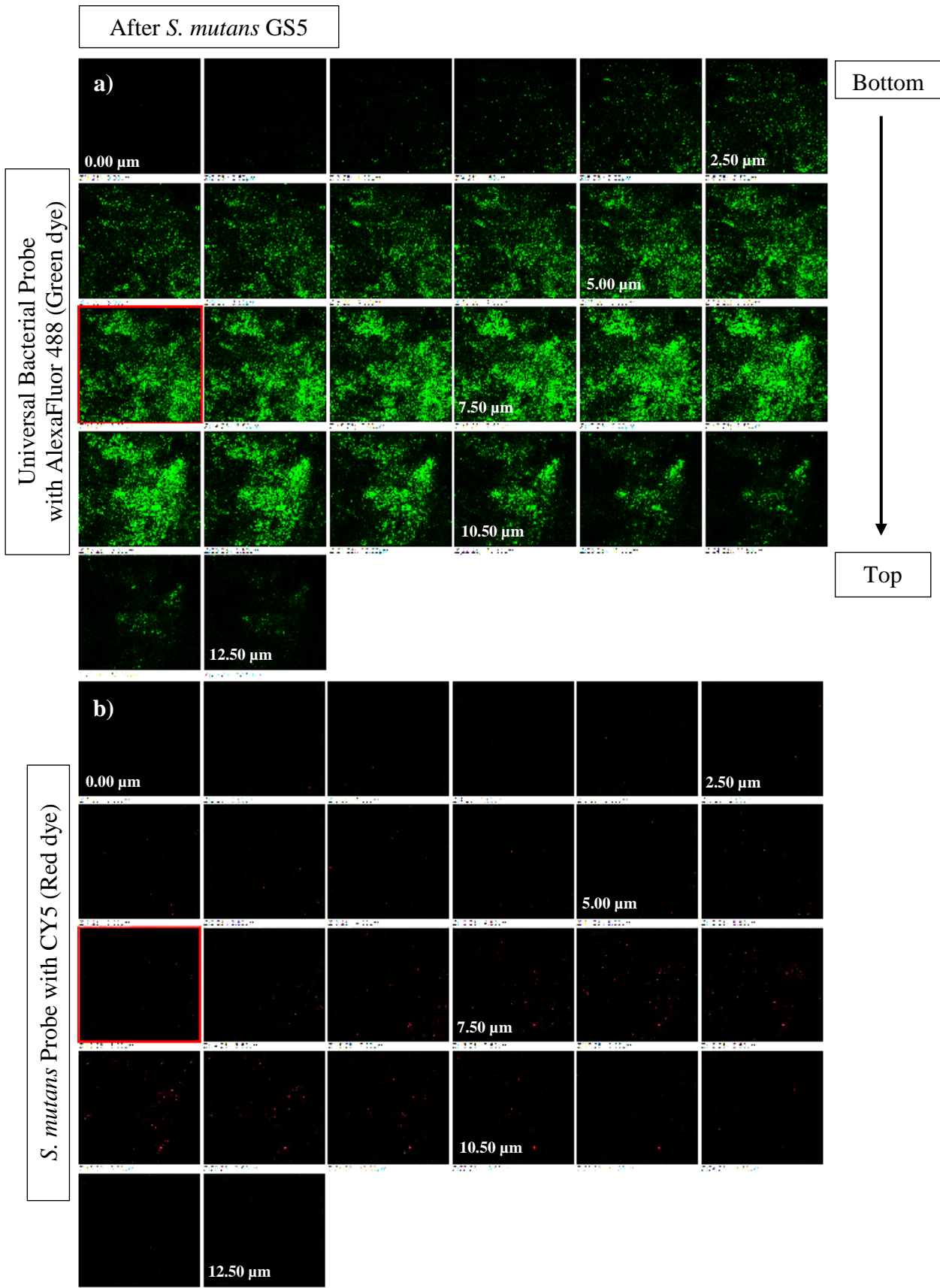

Figure 5. 5 Sectioned CLSM imaging of FISH detection biofilms after *S. mutans* GS5 inoculation. Incorporation of *S. mutans* GS5 among biofilm sections was recognised by red fluorescent detection from the specific *S. mutans* FISH probe (d).

#### **5.2.4 SEM of mixed species biofilm**

Mixed species biofilms before and after *S. mutans* GS5 inoculation were imaged by SEM to assess the biofilm structure at high resolution and to evaluate if the presence of sucrose affected the matrix structure of biofilms. SEM images (Figure 5. 6) demonstrated chains of cocci in biofilms cultured in 0.1% sucrose before and after *S. mutans* GS5 addition (Figure 5. 6b, and d). Matrix substance appeared as a thread like shapes, and granules were also observed. These matrix substances were better recognised within biofilms after inoculation of *S. mutans* GS5 (Figure 5. 6c, and d), when compared with biofilms before inoculation (Figure 5. 6a, and b).

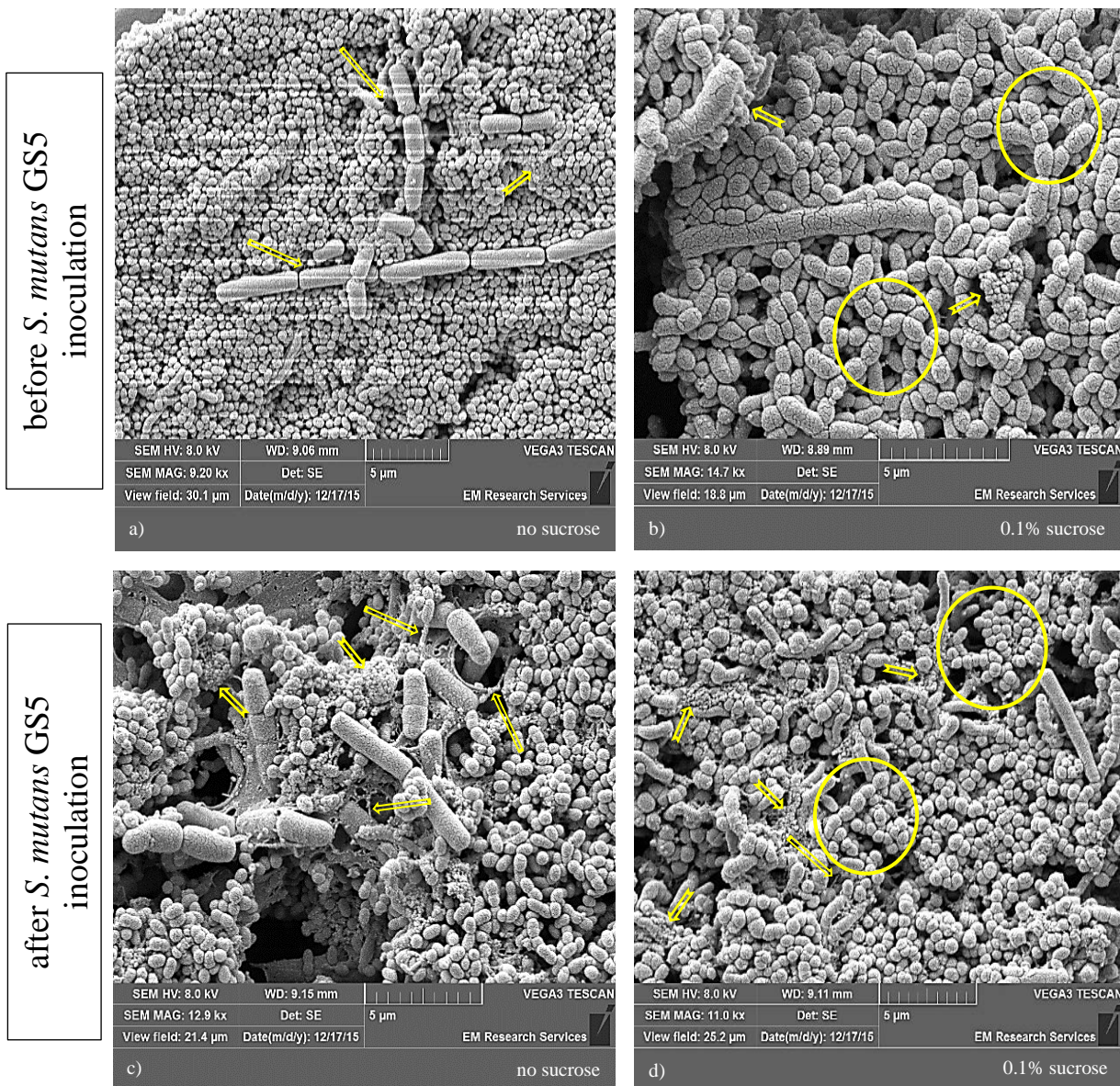

Figure 5. 6 SEM images of mixed species biofilms before (a, b), and after (c, d) challenging with *S. mutans* GS5. Chains of cocci (yellow circles) tended to be more predominant in mixed species biofilms in the presence of sucrose (right panels) in comparison with sucrose absence (left panels). Biofilm matrix substances were distributed between the bacterial cells either as threads (long striped arrows), or as granules (short notched arrows). The matrix substances of biofilms were somewhat clearer after *S. mutans* GS5 inoculation (c, d) in comparison with biofilms before inoculation (a, b).



### **5.2.5 Visualisation of EPS in mixed species biofilms with *S. mutans* GS5 by CLSM**

The matrix EPS of mixed species biofilms inoculated with *S. mutans* GS5 was visualised using CFW dye to assess the effect of sucrose on challenged biofilms (see Section 2.5.2). Images (Figure 5. 7) showed the EPS in mixed species biofilms cultured without (left panels), and with 0.1% sucrose (right panels). The red fluorescent detection of the biofilms' bacterial cells with PI dye did not show large differences in biofilm mass in either the absence or presence of sucrose (Figure 5. 7a, and b). In contrast, EPS detected with CFW dye (blue fluorescence) was clearly more abundant in biofilms cultured in the presence of sucrose (Figure 5. 7c, and d).

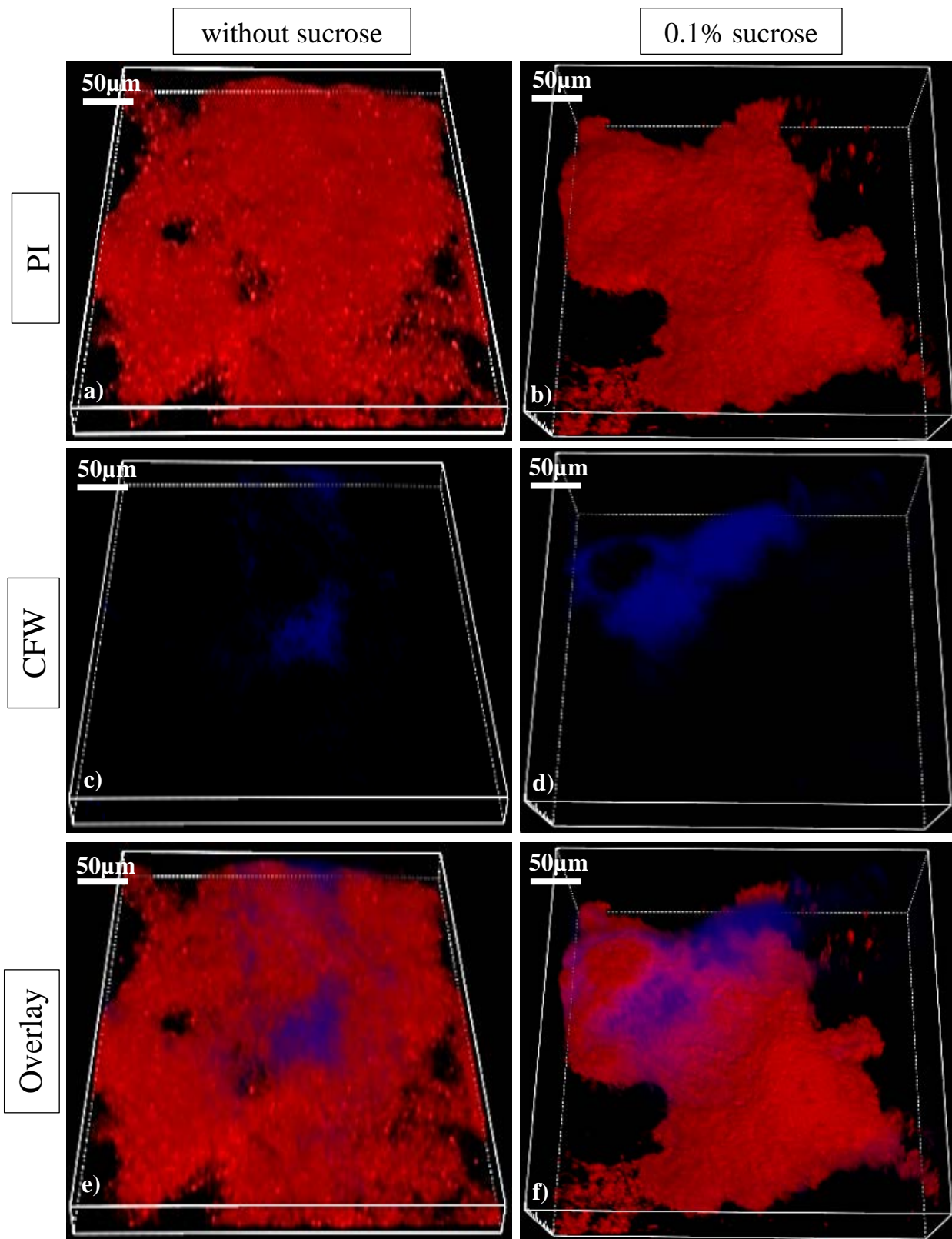

Figure 5. 7 CLSM images of mixed species biofilms with *S.mutans* GS5 to show the exopolysaccharide (EPS) substance in the biofilms matrix. The left panels represent biofilms without sucrose, while the right panels have 0.1% sucrose. Images (a) and (b) show bacterial cells stained with PI (Red); images (c) and (d) show exopoly-saccharide stained with CalcoFluor White (CFW) (Blue), and (e, f) are overlays of both dyes. The scale bar is 50µm.

### 5.3 Development of Early Coloniser Mixed Species Biofilms with *S. gordonii ssnA* (DNase) Mutant

Initially, mixed species biofilms were developed with *S. gordonii ssnA* in place of *S. gordonii* DL1. The impact of the *S. gordonii ssnA* disruption on biofilms was assessed using a variety of techniques. The biofilms were established with and without 0.1% sucrose via the MRD. The assembling and running of the MRD was performed as described previously in Section 2.3.2.

#### 5.3.1 Comparison of bacterial cell numbers in early coloniser mixed species biofilm with *S. gordonii* DL1 Vs *S. gordonii ssnA* (DNase) mutant

Levels of *V. parvula*, *A. oris*, and *S. gordonii* in mixed species biofilms containing either *S. gordonii* DL1 or *S. gordonii ssnA* were quantified by qPCR. There appeared to be small (approximately two-fold) increases in *A. oris* and *V. parvula* in biofilms containing *S. gordonii ssnA*, compared with *S. gordonii* DL1 in the absence or presence of sucrose (Figure 5. 8). However, none of the differences were statistically significant ( $p > 0.05$ ).

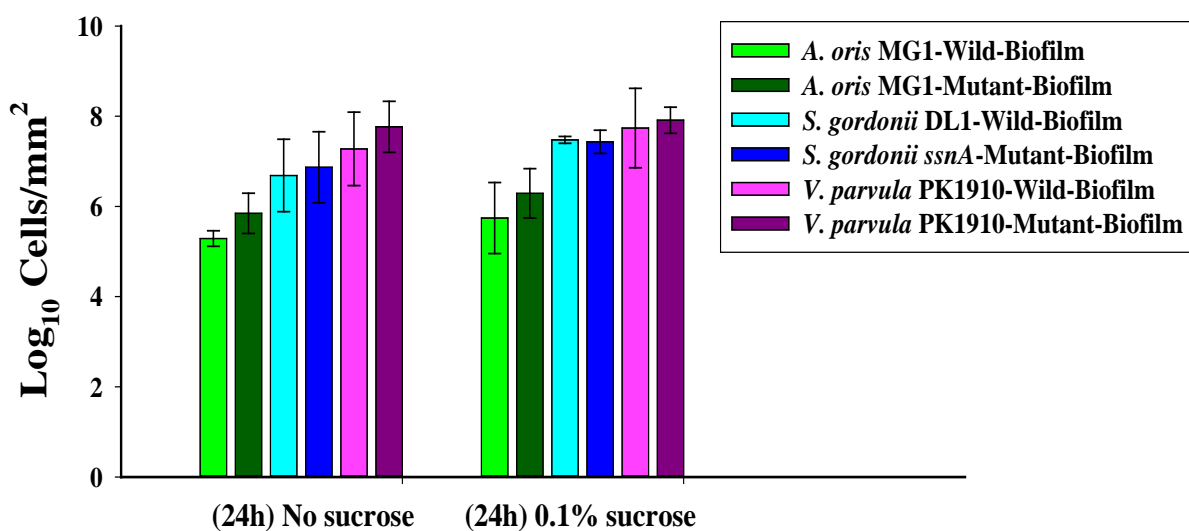

Figure 5. 8 Comparison between the quantification of bacterial cells in early coloniser mixed species biofilms with *S. gordonii* DL1 Vs *S. gordonii ssnA*. Bacterial cells were quantified by qPCR after 24 h in biofilms cultured without or with 0.1% sucrose. Mean  $\pm$  SD of three independent runs of the MRD are shown. Slight (two-fold) increases in *A. oris* and *V. parvula* counts were observed in biofilms containing *S. gordonii ssnA* but these were not statistically significant ( $p > 0.05$ ).

## 5.4 Inoculation of *S. mutans* GS5 within Preformed Mixed Species Biofilms with Mutant *S. gordonii ssnA*

Early coloniser mixed species biofilms with *S. gordonii ssnA* were inoculated with *S. mutans* GS5. The impact of the *ssnA* gene knockout on *S. mutans* colonisation and on the extracellular matrix was investigated.

### 5.4.1 Quantification of *S. mutans* GS5 in mixed species biofilms with *S. gordonii ssnA* by qPCR

Initially, cell numbers in biofilms containing *S. mutans* GS5 in combination with *A. oris* MG1, *V. parvula* PK1910, and *S. gordonii ssnA* were assessed by qPCR. There appeared to be a slight increase in *S. mutans* GS5 counts in the presence of sucrose (Figure 5. 9).

Furthermore, the number of *S. mutans* GS5 at zero time of inoculation within the biofilm, with and without sucrose, was  $2 \times 10^9$ . Following 24 h of inoculation within the biofilm, the numbers of *S. mutans* GS5 were  $3.45 \times 10^5$  and  $1.11 \times 10^6$  in biofilms with and without sucrose, respectively. The numbers of *A. oris* MG1, and *V. parvula* PK1910 were slightly increased in biofilm with sucrose, but none of these differences were statistically significant ( $p > 0.05$ ). By contrast, there was an approximate seven-fold increase in *S. gordonii ssnA* cell numbers in the presence of sucrose, and this difference was statistically significant ( $p < 0.05$ ).

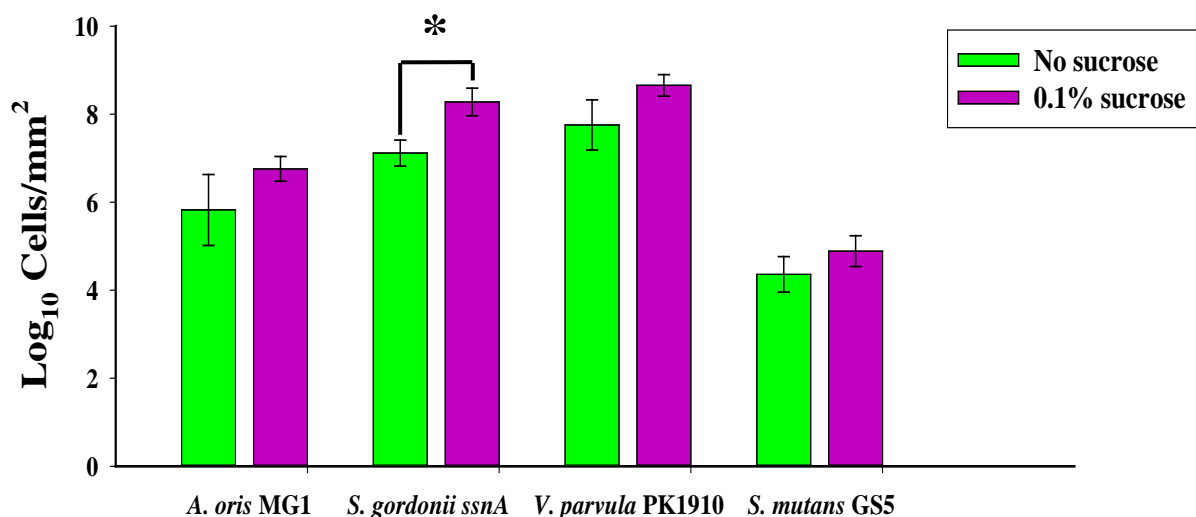

Figure 5. 9 Quantification of *S. mutans* GS5 cells in mixed species biofilms with *S. gordonii ssnA*. Numbers of bacterial cells were quantified by qPCR. Bars represent mean  $\pm$  SD of three independent experiments. There was a difference in *S. mutans* GS5 cell counts, as well as in *A. oris* and *V. parvula*, in the presence of sucrose. Statistically, these differences were not significant. In contrast, *S. gordonii ssnA* was increased with 0.1% sucrose, and this was statistically significant ( $p < 0.05$ ).

#### 5.4.2 Levels of *S. mutans* GS5 in mixed species biofilms with *S. gordonii* DL1 or *S. gordonii* *ssnA* with and without 0.1% sucrose

The quantification data of *S. mutans* GS5 in biofilms containing *S. gordonii* DL1 or *S. gordonii* *ssnA* were reported in Sections 5.2.1 and 5.4.1, respectively. Therefore, to assess whether switching the *S. gordonii* strain affected *S. mutans* colonisation, these data were compared. The comparison (Figure 5. 10) demonstrated a slight increase in *S. mutans* GS5 numbers in biofilms containing *S. gordonii* *ssnA* from those in biofilms with *S. gordonii* DL1. Although the differences were seen both with and without sucrose, in the with sucrose condition, higher numbers of *S. mutans* GS5 were seen. These differences in *S. mutans* GS5 counts were not statistically significant ( $p > 0.05$ ).

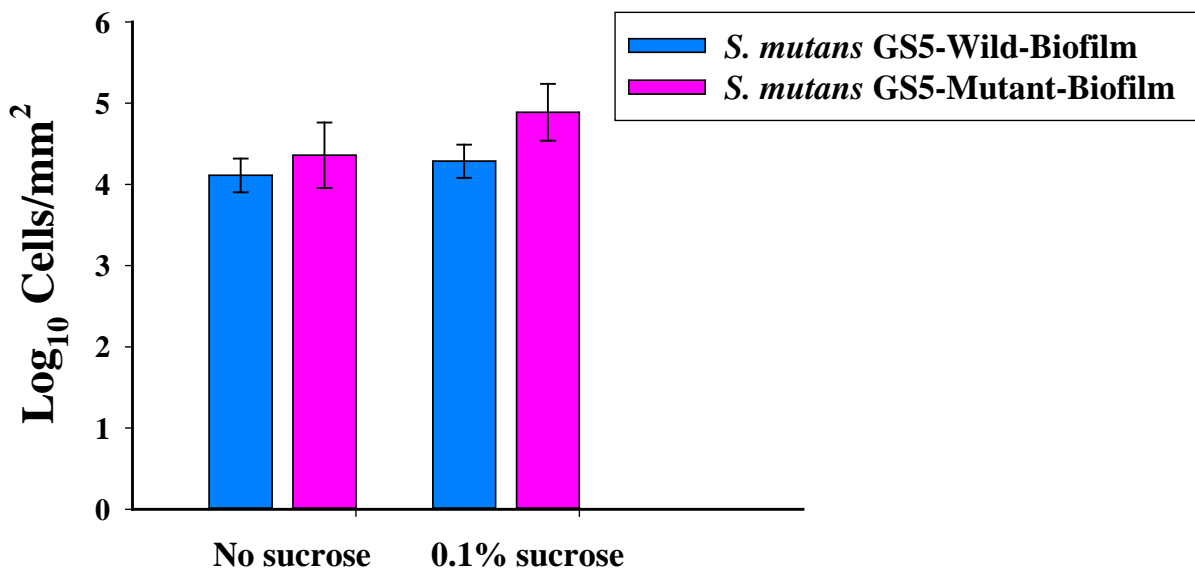

Figure 5. 10 Comparison between the quantification of *S. mutans* GS5 in mixed species biofilms with *S. gordonii* DL1 vs *S. gordonii* *ssnA*, with and without 0.1% sucrose. *S. mutans* GS5 cells were quantified by qPCR. Mean  $\pm$  SD of three independent experiments is shown. *S. mutans* GS5 numbers were slightly increased in biofilm with *S. gordonii* *ssnA* in comparison with *S. gordonii* DL1. These differences were not statistically significant ( $p > 0.05$ ).

#### ***5.4.3 Detection of S. mutans GS5 in mixed species biofilms containing S. gordonii ssnA by FISH***

FISH labelling was used to detect *S. mutans* GS5 in mixed species biofilms with *A. oris*, *V. parvula*, and *S. gordonii ssnA*. CLSM imaging (Figure 5. 11) demonstrated that *S. mutans* were detectable in biofilms 24h after inoculation. Biofilm image (Figure 5. 11d, and g) showed the integration of *S. mutans* GS5 within biofilms layers.

CLSM images of biofilms sections (Figure 5. 12) demonstrated FISH detection before inoculation of *S. mutans* GS5, the absence of *S. mutans* was confirmed as there was no signal shown by the *S. mutans* probe throughout the sections (Figure 5. 12b), and the only fluorescent signal was detected from the universal probe (Figure 5. 12a). In sectional images of the biofilms after culturing *S. mutans* GS5 within the biofilms (Figure 5. 13), in addition to the labelling of the biofilm with the universal FISH probe (Figure 5. 13a), the *S. mutans* probe detected the integration of *S. mutans* GS5 throughout the biofilm (Figure 5. 13b).

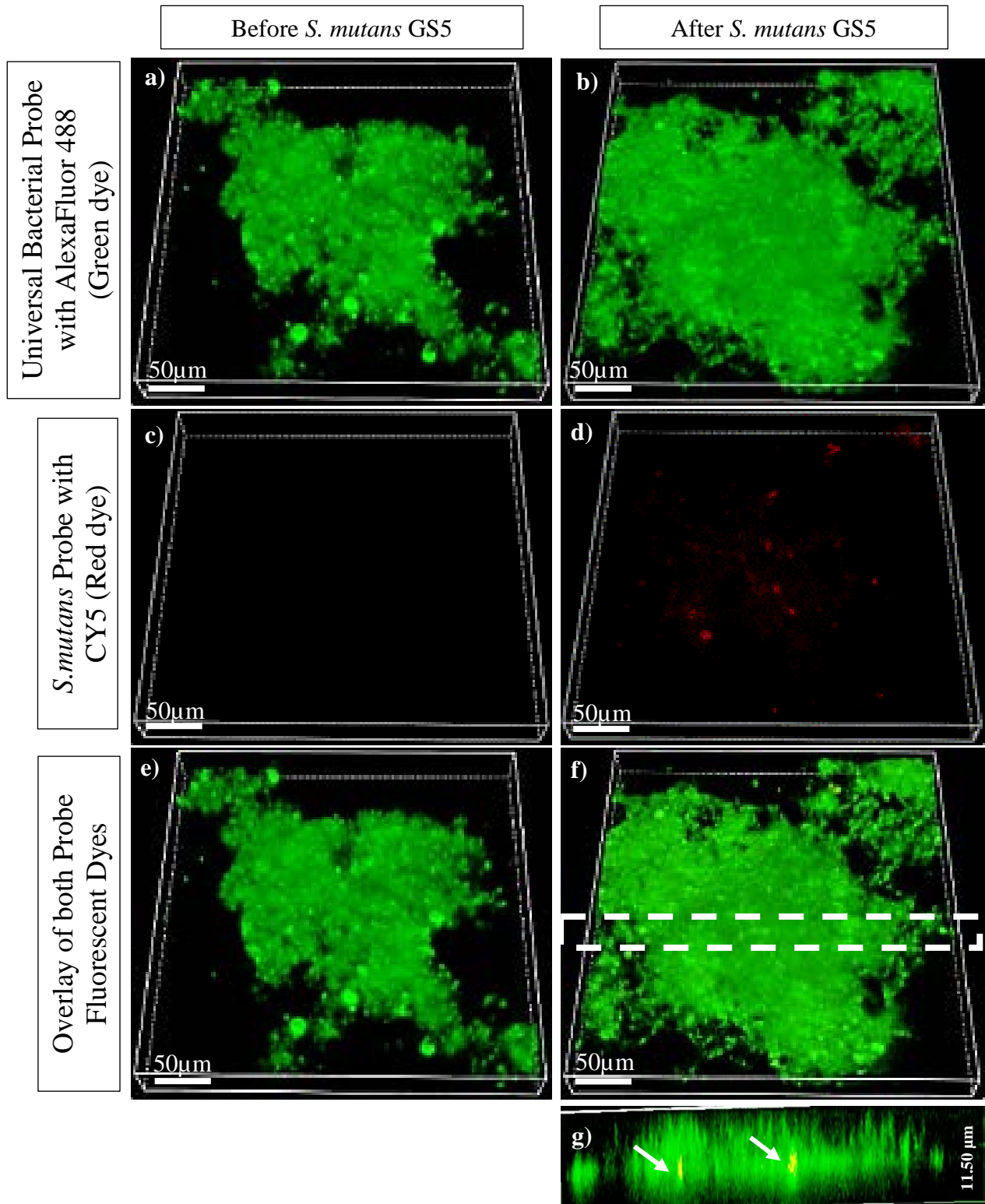

Figure 5. 11 CLSM images for mixed species biofilms containing *S. gordonii ssnA* before (left panels), and after (right panels) inoculation of *S. mutans* GS5. The universal probe (green fluorescence) detected all the bacterial cells within the mixed species biofilms (a, b). The *S. mutans* probe (red fluorescence) detected *S. mutans* GS5 integration within mixed species biofilms (d). Images (e, f) show the overlay of both fluorescent dyes of FISH PNA probes. A vertical slice showing *S. mutans* (white arrows) within the biofilm is shown (g), taken from the area indicated by the dashed rectangle in (f). The scale bar is 50µm.

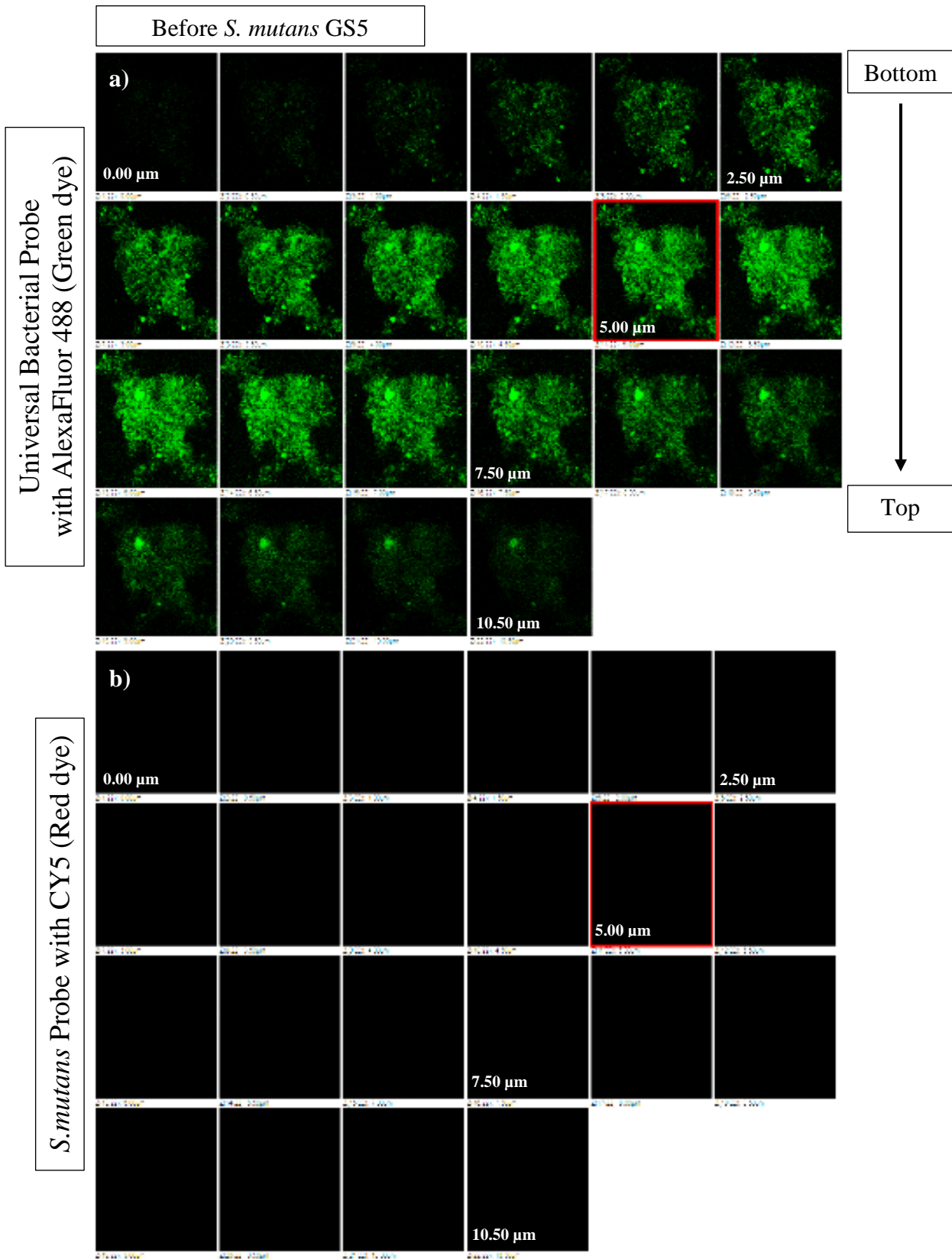

Figure 5. 12 CLSM sectioning imaging of biofilms labelled by FISH probes. The images show biofilms before *S. mutans* GS5 inoculation. Fluorescent green signalling was detected only from the universal probe in comparison to no red signal with the *S. mutans* probe (d).



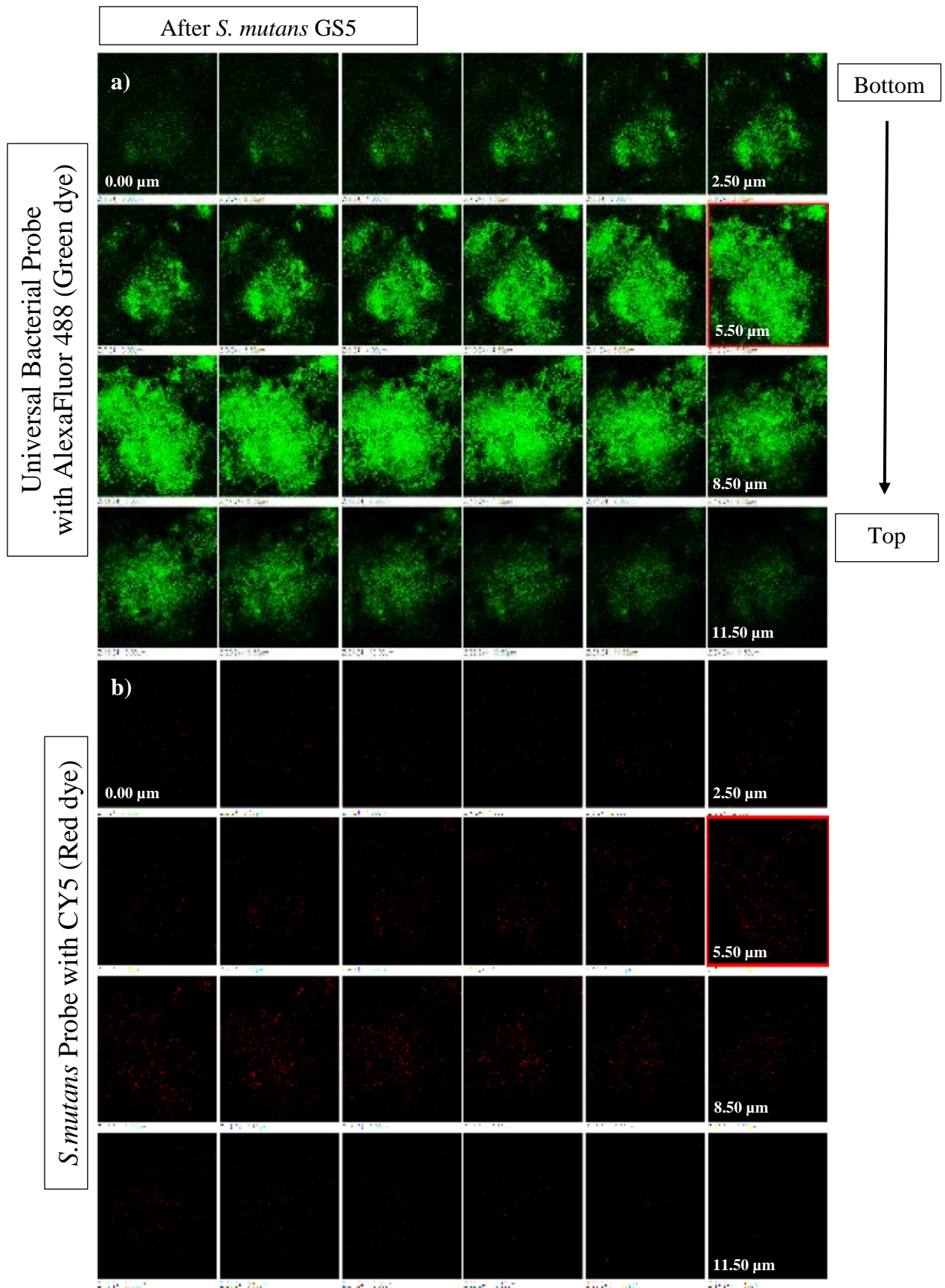

Figure 5. 13 CLSM sectional imaging of biofilms labelled by FISH probes. The images show biofilms after *S. mutans* GS5 inoculation. The *S. mutans* FISH probe shows red detection, labelling *S. mutans* GS5 incorporation within biofilms sections (d).

#### ***5.4.4 SEM of mixed species biofilms with S. gordonii ssnA before and after inoculation of S. mutans GS5***

The structure of mixed species biofilms with *S. gordonii ssnA* was visualised by SEM before and after inoculation of *S. mutans* GS5 within the biofilms (Figure 5. 14). Different bacterial morphologies were observed, and in addition biofilm matrix substances were apparent. In biofilms both before or after inoculation of *S. mutans* GS5, the chains of cocci were more predominant with sucrose (Figure 5. 14 right panels). SEM images revealed thread-like and granular structures within all biofilms, although they were slightly clearer in biofilms cultured with 0.1% sucrose (Figure 5. 14b, and d).

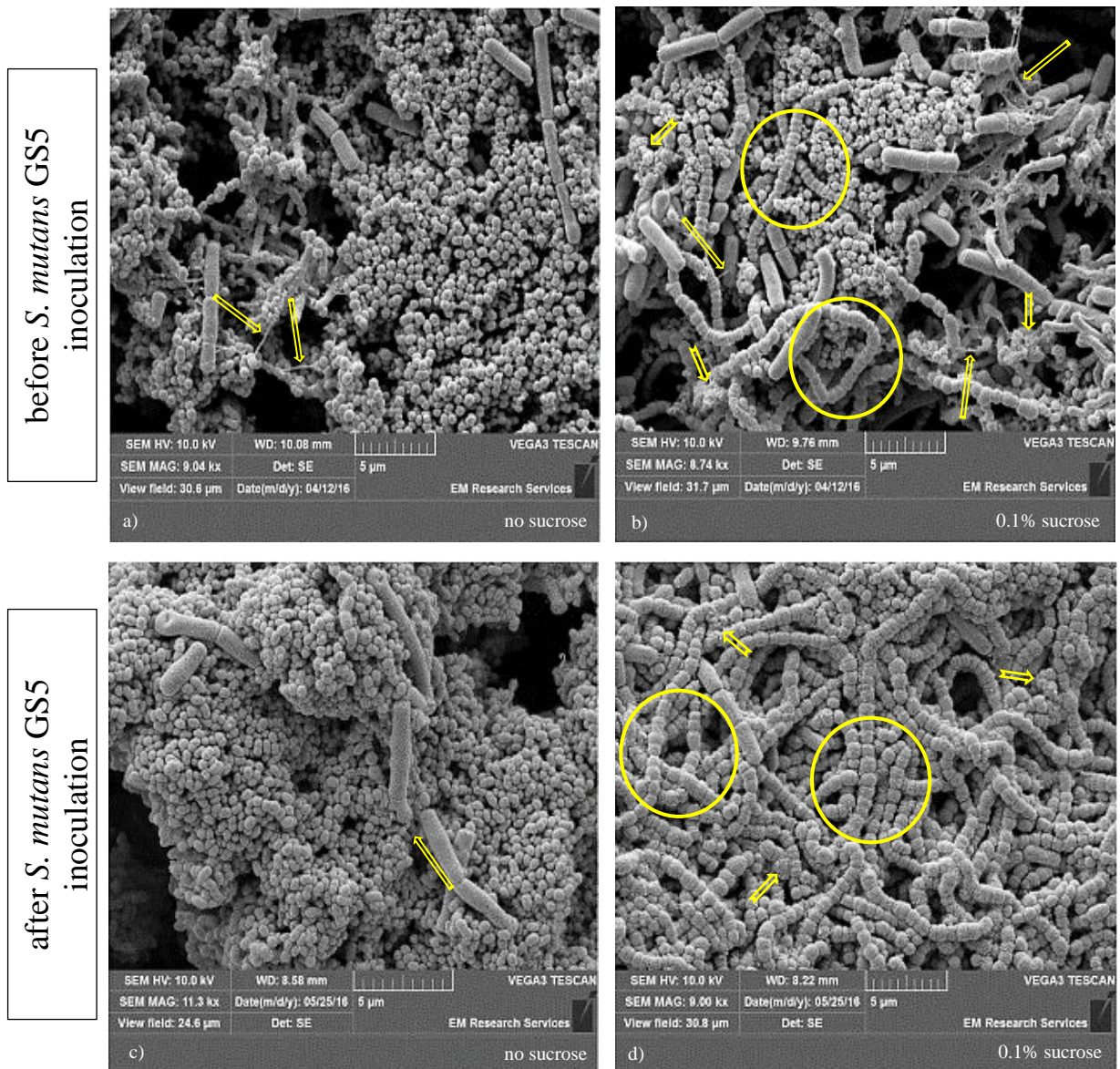

Figure 5. 14 SEM images of mixed species biofilms before (a, b), and after (c, d) inoculation of *S. mutans* GS5. The left panels represent mixed species biofilms with *S. gordonii ssnA* without sucrose, while the right panels represent biofilms with 0.1% sucrose. Chains of cocci (yellow circles) tended to be more predominant in mixed species biofilms grown with sucrose in comparison with those cultured without sucrose. Biofilm matrix substances were distributed between bacterial cells either as thread shapes (long striped arrows), or as granules on the surfaces of the bacterial cells (short notched arrows).

#### ***5.4.5 Visualisation of EPS in mixed species biofilms containing *S. gordonii ssnA* and *S. mutans* GS5 with and without 0.1% sucrose by CLSM***

The fluorescent dye CFW was used to label the EPS of biofilm matrix in mixed species biofilm with *S. gordonii ssnA* after inoculation of *S. mutans* GS5, to assess the effects of the *ssnA* deletion on the appearance of biofilm matrix EPS. Cells were counterstained with PI. CLSM images (Figure 5. 15) demonstrated EPS in biofilms cultured without sucrose (Figure 5. 15 left panels), and with sucrose (Figure 5. 15 right panels). There was much more EPS in biofilms grown with 0.1% sucrose (Figure 5. 15d) than without sucrose (Figure 5. 15c), although EPS levels were not quantified.

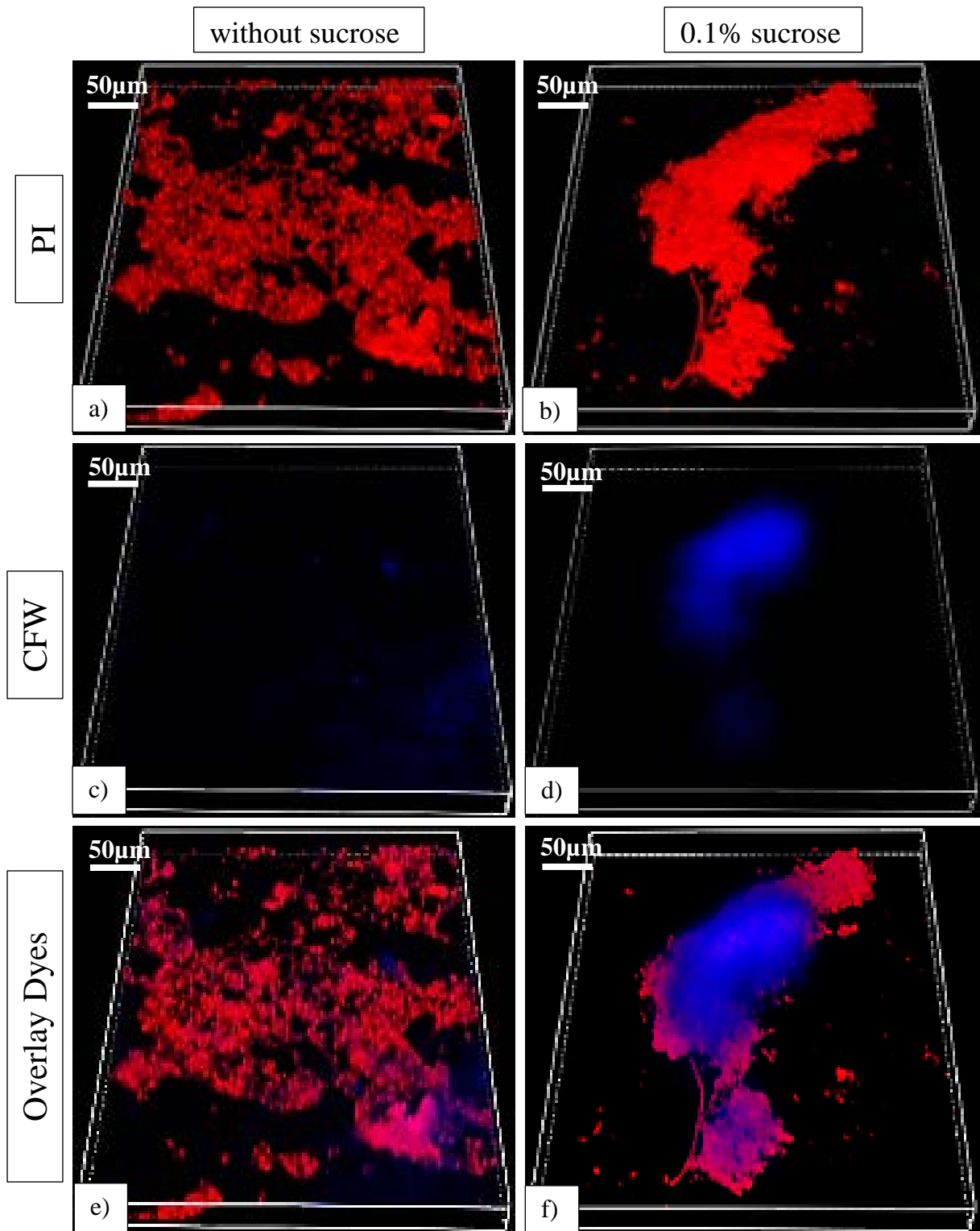

Figure 5. 15 CLSM images of mixed species biofilm with *S. gordonii ssnA*, and inoculated *S. mutans* GS5, to show EPS of the biofilm matrix. The left panels represent the biofilms cultured without sucrose, while the right panels represent those grown with 0.1% sucrose. Images (a) and (b) show bacterial cells stained with PI (red fluorescence). By staining with CFW, there appeared to be more EPS (c) and (d) (blue fluorescence) in biofilms grown with sucrose. Panels (e) and (f) show overlays of both dyes. The scale bar is 50µm.

#### ***5.4.6 Fluorescent labelling and CLSM imaging of eDNA in mixed species biofilms with *S.gordonii ssnA* and *S. mutans* GS5 with and without 0.1% sucrose***

The eDNA of mixed species biofilm with mutant *S. gordonii ssnA* after the inoculation of *S. mutans* GS5 was labelled by PicoGreen. The bacterial cells in biofilms were labelled with Nile Red. CLSM images of biofilms (Figure 5. 16) showed eDNA labelling in biofilms grown in the absence (Figure 5. 16 left panels), or presence of sucrose (Figure 5. 16 right panels). In red fluorescence labelling of biofilms mass, concentrated areas of dye were recognised with 0.1% sucrose compared to without (Figure 5. 16a, and b), chains of bacterial cells were also seen (Figure 5. 16b). With green fluorescent labelling, there appeared to be eDNA, particularly in areas of high cells density, and there was evidence of eDNA in the absence or presence of sucrose (Figure 5. 16c, and d).

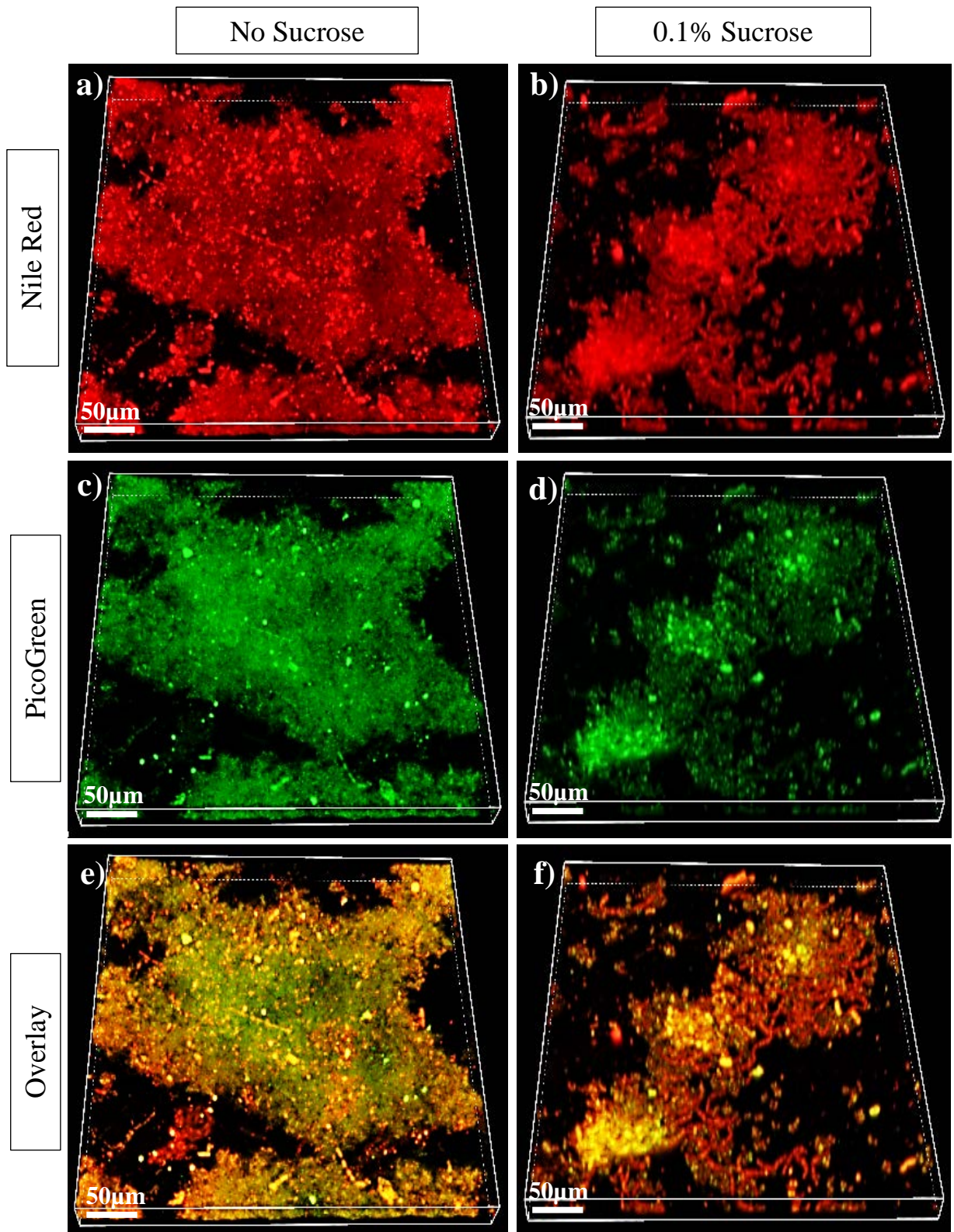

Figure 5. 16 Fluorescent labelling of the biofilms matrix eDNA. The images show biofilms without (left panels), and with 0.1% sucrose (right panels). The red fluorescence shows areas of dye concentration in biofilm mass with sucrose (b) in comparison to without (a), and the appearance of bacterial chains was also shown. Green fluorescence, indicating eDNA, was apparent in biofilms grown with or without sucrose (c and d). The scale bar is 50µm.

## 5.5 Discussion

*S. mutans* GS5 was able to integrate within the preformed early coloniser mixed species biofilms, and the presence of 0.1% sucrose did not lead to significantly different levels of colonisation compared with biofilms cultured without sucrose. Colonisation of preformed biofilms by *S. mutans* GS5 was almost 20-times lower than *S. mutans* UA159 in the presence or absence of sucrose. The estimated total number of *S. mutans* GS5 cells in the MRD after 24 h were  $1.66 \times 10^5$  without sucrose and  $2.50 \times 10^5$  with 0.1% sucrose. This was lower than the inoculum, which was  $2 \times 10^9$ . Therefore, it is not clear whether or not the *S. mutans* GS5 cells grew in the MRD. It is possible that GS5 was impaired in either adhesion or growth, compared with UA159. To test the ability of GS5 to grow in the model, it would be necessary to follow cell numbers over a longer period than just 24 h. Alternatively, we could test initial adhesion by looking at a shorter time point (e.g., 2 h).

Laboratory isolated *S. mutans* GS5 has been shown to have mutations in *gbpC* and *pac* genes. These genes encode production of the glucan-binding protein GbpC and surface adhesion PAC (cell surface adhesions Antigen I/II). The GbpC protein has been shown to promote dextran-dependent aggregation by interacting with the dextrans produced by primary plaque-colonising species (Sato *et al.*, 1997). Moreover, the PAC has been shown to interact primarily with the glycoprotein salivary agglutinin complex (SAG) of the salivary acquired pellicle on tooth surface (Heim *et al.*, 2015). Thus, the mutation can affect the adhesion ability of *S. mutans* GS5, and in turn may also interfere with the establishment of biofilms (Sato *et al.*, 2002; Lynch *et al.*, 2007). It is unlikely that the *gbpC* mutation is important in the absence of sucrose since glucans will not be produced. Sequencing the genome of *S. mutans* UA159 revealed an absence of such mutation within UA159 (Ajdić *et al.*, 2002). Further investigations using targeted genetic mutants are required to understand the molecular basis of the colonisation of preformed biofilms by *S. mutans*.

Recent work in our laboratory has identified differences in the sensitivity of *S. mutans* GS5 biofilms to DNase treatment compared with *S. mutans* UA159. Specifically, about 80% of monoculture *S. mutans* GS5 biofilm was inhibited during the biofilm formation or dispersed after the biofilm had been established by the DNase treatment, while neither inhibition nor dispersion of *S. mutans* UA159 monoculture biofilm were shown to have occurred by the DNase treatment (Shields, 2014). The *S. gordonii* *ssnA* gene is responsible for producing the SsnA extracellular nuclease (DNase enzyme) that affects eDNA (Perry *et al.*, 2009; Das *et al.*, 2011), and the *S. mutans* GS5 may depend on eDNA for its adhesion function, as mentioned



previously. It has been shown that *S. mutans* GS5 biofilm was reduced about 40% by *S. gordonii* DNase enzyme SsnA, which degrades the eDNA of the biofilm matrix, reducing biofilm stability, and affecting *S. mutans* GS5 colonisation (Shields, 2014). Thus, according to this, we hypothesise that if mutant *S. gordonii* *ssnA* where the *ssnA* gene was knocked out is replaced with the wild-type *S. gordonii* DL1 in preformed mixed biofilm, there may be a possibility that the *S. mutans* GS5 is able to colonise better in the absence of DNase than when DNase is present. Also, the colonisation of *S. mutans* GS5 may be affected by the eDNA that is likely to be more present in the biofilm matrix as a result of *S. gordonii* mutation.

Replacing *S. gordonii* DL1 in the biofilm with *S. gordonii* *ssnA* did not greatly affect the bacterial numbers in newly established preformed mixed biofilms. There were slight increases in all species, but these were not statistically significant. Further, the presence or absence of sucrose also had no effect. Thus, the newly established biofilms were again reproducible and were used to assess the effect of *S. gordonii* *ssnA* on *S. mutans* GS5. The *S. gordonii* *ssnA* biofilm did not affect the ability of *S. mutans* to colonise. Although the number of *S. mutans* GS5 was slightly increased from their number in biofilms within wild-type *S. gordonii*, differences were not statistically significant. Therefore, *S. gordonii* SsnA DNase is not a major factor that inhibits colonisation by *S. mutans* under the conditions employed within this study. It has been shown that *A. oris* produces extracellular DNase activity under some circumstances (Palmer *et al.*, 2012), and it is possible that this functionally complements the *S. gordonii* *ssnA* gene knockout. It would be interesting to test whether *S. gordonii* SsnA affects *S. mutans* GS5 colonisation in a system that lacks other extracellular DNase activities. This could be achieved by omitting *A. oris* or by identifying the gene responsible for *A. oris* DNase activity and generating a targeted knockout mutation.

It is possible that the eDNA in the biofilm matrix may have been amplified by qPCR, giving an artificially high cell count for some or all of the species in the biofilm. Using vitality qPCR, up to two thirds of *S. mutans* DNA in mature biofilms was found to be accessible to PMA and potentially either extracellular or in dead cells (Yasunaga *et al.*, 2013). In future studies it will be of interest to determine what proportion of DNA from each species in the system is extracellular using a similar vitality qPCR approach. To assess the importance of eDNA, attempts were made to visualise eDNA in selected biofilms. In preformed biofilms with mutant *S. gordonii* *ssnA*, eDNA was observed in biofilms grown with sucrose as well in biofilms without. Although eDNA was not quantified, the fluorescent labelling of eDNA

using PicoGreen demonstrated concentrated areas of eDNA in patches rich in cells and was clearer in biofilms grown with 0.1% sucrose than without sucrose. PicoGreen was used to visualise eDNA in mixed species biofilm of *Reinheimera* sp. F8, *Serratia* sp. FW2, *Pseudomonas* sp. FW1, and *Microbacterium* sp. FW3 (Tang *et al.*, 2013). The fluorescent dye showed the labelling of eDNA as a cloud or as strings surrounding or in between the bacterial cells of the biofilm without being bound to intracellular DNA. Further investigations are required to assess how knocking out the *ssnA* gene affects the appearance of eDNA in the matrix of biofilms with wild-type *S. gordonii* DL1 and mutant *S. gordonii ssnA*.

In preformed mixed species biofilms with *S. gordonii ssnA*, there were significant differences in *S. gordonii ssnA* bacterial cell numbers in biofilm with sucrose from biofilm without sucrose. Such significant differences were observed with mutant *S. gordonii ssnA* and not with wild-type *S. gordonii* DL1 (see Section 5.2.1). It is possible that *S. gordonii* glucans produced from sucrose interact with eDNA and promote biofilm formation, if SsnA is not present. The interaction between exopolysaccharide and eDNA was demonstrated previously in the matrix of monoculture biofilms of other bacterial species such as *M. xanthus* and *P. eruginosa* (Hu *et al.*, 2012; Jennings *et al.*, 2015). Further investigation to assess the presence of such interaction and compare biofilms with wild-type *S. gordonii* DL1 and mutant *S. gordonii ssnA* is required to understand how this can affect *S. gordonii* growth. Alternatively, it is possible that the disruption of *ssnA* may alter the central metabolism and affect the ability of *S. gordonii* to grow in the presence/absence of sucrose. In contrast, non-significant differences were recorded in the numbers of *A. oris* MG1 and *V. parvula* PK1910 in the newly preformed biofilm with *S. gordonii ssnA*, following inoculation of *S. mutans* GS5.

In summary, challenging the preformed mixed species biofilm with another *S. mutans* strain (GS5) showed their incorporation within the biofilm, but it was unclear if such incorporation was due to bacterial cell growth or adhesion. Further experiments are required to look more closely at adhesion versus growth. The significant difference between the numbers of different *S. mutans* strains (UA159-GS5), although inoculated into the same preformed early coloniser mixed species biofilm model, have shown that there are strain-dependent differences in the ability of *S. mutans* to colonise in our model. The colonisation of *S. mutans* GS5 was not dependent on an extracellular DNase, *ssnA* in *S. gordonii*, even though the purified protein strongly inhibits *S. mutans* GS5 biofilm formation in vitro. Therefore, it is likely that the colonisation of pre-existing biofilms is a complex process that requires multiple

factors. *S. mutans* genes such as *pac* and *gbpC* may be important and further studies using genetic approaches will be needed to dissect the molecular pathways of biofilm colonisation by *S. mutans*. In addition, it will be important to employ quantitative techniques that specifically enumerate viable cells, since eDNA was shown to be present in biofilms and likely will have been amplified by qPCR giving artificially high estimates of cell numbers.



## Chapter 6. Overall Perspective

### 6.1 General Discussion

A key goal of this thesis was to produce a stable mixed-species model of early dental plaque biofilm that could be challenged with *S. mutans*, in order to explore the mechanisms underpinning *S. mutans* biofilm colonisation. The model that was developed from three pioneer coloniser species *A. oris* MG1, *S. gordonii* DL1, and *V. parvula* PK1910 was shown to be reproducible and stable. The three species were selected because interactions between them have already been characterised in some detail. For example, there is a synergistic relationship between *S. gordonii* and *V. parvula* which provides a suitable environment for the survival and growth of the obligate anaerobe *V. parvula* in an overtly aerobic environment (Bradshaw *et al.*, 1998). At the same time, *S. gordonii* amylase expression is increased when *V. parvula* is present in close proximity to *S. gordonii* cells. This is thought to increase the rate by which *S. gordonii* ferments carbohydrates to lactic acid, and to benefit *V. parvula*, which utilises lactic acid as a key source of energy for growth (England *et al.*, 2004; Johnson *et al.*, 2009; Washio *et al.*, 2014). At the same time, it was likely that there was an antagonising effect by *S. gordonii* on *A. oris*, resulting from *S. gordonii* production of H<sub>2</sub>O<sub>2</sub> (Jakubovics *et al.*, 2008), and this was shown by the lower numbers of *A. oris* in comparison with other pioneer species in our developed biofilm. In spite of this antagonistic relationship, coaggregation between *S. gordonii* and *A. oris* can be assisted to avoid oxidative damage that may affect *S. gordonii* due to self-produced H<sub>2</sub>O<sub>2</sub> (Jakubovics *et al.*, 2008). Overall, *A. oris* was maintained in the community at lower levels than the other two species. This is consistent with similar models, where *Actinomyces naeslundii* has been shown to be retained at relatively low levels for up to 67 h within mixed-species biofilms containing *S. gordonii* and *S. mutans* (He *et al.*, 2016).

The addition of 0.1% sucrose did not affect levels of pioneer species cells within the biofilms; no significant differences were shown in the quantification of each pioneer species, whether the sucrose was present or absent. In addition, sucrose had little impact on the biofilm matrix structure. The matrix appeared as threads and granules in both biofilms with and without sucrose. It is likely that the major matrix substances were not glucans or fructans, but instead may be other polysaccharides, eDNA, proteins or other macromolecules. Similarly, there were no significant differences in the numbers of *S. mutans* UA159 or GS5 in the presence or absence of sucrose. Although there were more observations in presence of the matrix substances, whether thread-like or granulates in preformed mixed biofilm following challenge

with *S. mutans* UA159, again this was regardless of the addition of 0.1% sucrose. It seems that glucans and fructans are unlikely to be the major constituents because there was little difference in the matrix structure with or without sucrose. In the absence of sucrose, *S. mutans* can produce another biofilm matrix substance, which is the eDNA, when inducing cell death by activating their competence-stimulating/ inducing peptides CSP/XIP signalling (Petersen *et al.*, 2005; Perry *et al.*, 2009; Wenderska *et al.*, 2012). Furthermore, another pathway, such as membrane vesicles, and protein secretion and membrane insertion pathway, can be dependent on *S. mutans* producing the eDNA (Liao *et al.*, 2014). In contrast to mixed-species biofilms, the matrices of monoculture *S. mutans* biofilms were clearly affected by 0.1% sucrose addition. With sucrose, there was a clear observation of granulates matrix substance in comparison to matrix substances in biofilm without sucrose, which seemed not even to be present. It was found that, at sucrose concentration of 0.01mM, *S. mutans* was able to produce a detectable amount of EPS, and the amount increased with increasing sucrose concentration (Shumi *et al.*, 2010). In this study, the sucrose concentration used was approximately 2.9 mM, which is more than what has been considered the minimum concentration for producing detectable EPS.

The use of a continuous flow system such as MRD to establish biofilm models was aimed at modelling the oral environment. The reasons for this are: (i) it is an open system with continual flow of nutrients in and out; (ii) the system contains mixtures of bacteria, and even though these are much simpler than the natural microbiota, the system is designed to replicate some of the key interspecies interactions that occur in dental plaque; and (iii) the surfaces were conditioned with natural human saliva, providing a kind of pellicle for bacterial attachment (Lendenmann *et al.*, 2000). The MRD has previously been used to test the effects of different antibacterial agents against biofilm formation (Coenye *et al.*, 2008), rather than use it to develop mixed species biofilms for further challenging with other bacterial species, as in this study. The stainless steel biostuds demonstrated their initial suitability to be used as substrate for establishing biofilms, since there were no detectable differences in qualitative comparison between these and tooth section biostuds. This may therefore provide an alternative to hydroxyapatite discs used previously as substrate (Blanc *et al.*, 2014).

Challenging the stable preformed early coloniser mixed species biofilms with *S. mutans* UA159 showed their ability to colonise within the biofilms. The colonisation of *S. mutans* inside the oral cavity is thought to occur by attachment to a biofilm that has already accumulated on the tooth surface. Additionally, *S. mutans* are not included within the oral

microflora of a newly born foetus, as sampling of newly born oral mucosa less than five minutes after birth showed bacterial species such as *Lactobacillus*, *Prevotella*, *Atopobium*, or *Sneathia* spp., and *Staphylococcus* spp. (Dominguez-Bello *et al.*, 2010). *S. mutans* is acquired from the surrounding environment as the baby's age increases, and they colonise inside the oral cavity either before or after the eruption of primary teeth (Caufield *et al.*, 1993; Gizani *et al.*, 2009; Cephas *et al.*, 2011). In the model used here, it is likely that the bacterial competition among the different species in the mixed biofilms after *S. mutans* UA159 challenging, whether synergistic or antagonistic, remained in balance. The production of H<sub>2</sub>O<sub>2</sub> by *S. gordonii* can have an inhibitory effect on *S. mutans* colonisation (Zheng *et al.*, 2011; Zeng *et al.*, 2012). The opposite response of *S. mutans* to compete with such an inhibitory effect is to produce protective bacteriocins (Kreth *et al.*, 2005b; Kreth *et al.*, 2008). At the same time, the competence system of *S. mutans* may be activated, producing more bacteriocins due to the effect of DNA produced by *S. gordonii* (Kreth *et al.*, 2005b; Kreth *et al.*, 2008). Another factor that may be considered to affect such bacterial competitive interaction is the presence of *V. parvula* in mixed biofilm, in addition to *S. gordonii* and *S. mutans*; better growth of *S. mutans* has been shown in triplicate species mixed biofilm with *S. gordonii* when *V. parvula* is present, in comparison to their growth in dual mixed species with only *S. gordonii* (Liu *et al.*, 2011). Mutualistic growth can occur with *S. mutans* and *V. parvula* in biofilm establishment, which is likely to be due to the presence of a metabolic relationship between these two species (Kara *et al.*, 2007; Aas *et al.*, 2008).

The preformed early colonisers mixed species biofilms also remained stable after challenging with *S. mutans* GS5. Although *S. mutans* GS5 was identified within the biofilm, levels were significantly lower than found with *S. mutans* UA159, indicating that there was variation between the ability of each strain to colonise the preformed mixed species biofilm. Additionally, there were no clear changes in the appearances of biofilm matrix substance before and after *S. mutans* GS5 inoculation within the preformed early colonisers mixed species biofilms, in contrast to the previously mentioned changes occurring in biofilm matrix substances presentation with inoculation of *S. mutans* UA159. *S. mutans* GS5 was highly cariogenic in early animal studies and in particular was able to cause smooth surface lesions (Sharawy and Socransky, 1967; Kuramitsu, 1973). However, cariogenicity rapidly reduced following storage and subculture in the laboratory (Sato *et al.*, 2002). Mutations have been identified in the key colonisation determinants of *S. mutans* GS5, *pac* and *gbpC*, which may be responsible for their reduced cariogenicity and also for the reduction in colonisation of pre-existing biofilms observed here. Genetic variation has been also demonstrated between *S.*

*mutans* strains recently isolated from people with dental caries and *S. mutans* UA159, and affect characteristics such as sensitivity to low pH, oxidative stress, and exposure to CSP (Palmer *et al.*, 2013). Even the ability to develop biofilm in glucose and sucrose was significantly different in relation to such variation. In addition, it has been shown that the different adoptive growth strategies can develop due to phenotypic diversity of isolated *S. mutans* strains, in order to survive inside the oral cavity, and may initiate dental caries formation under favourable conditions (Palmer *et al.*, 2013).

The final section of this study was to test our hypothesis that eDNA in biofilm matrix affects the colonisation ability of *S. mutans* GS5 within preformed mixed species biofilm, using mutant *S. gordonii* *ssnA* which does not produce an extracellular DNase. In previous laboratory findings, it had been demonstrated that purified *S. gordonii* SsnA inhibited the formation of *S. mutans* GS5 monoculture biofilms, or dispersed preformed biofilms (Shields, 2014). However, disruption of the *ssnA* gene in *S. gordonii* did not appear to affect colonisation by *S. mutans* or by *V. parvula* or *A. oris*. Although there was a noticeable presentation of eDNA in the biofilm matrix, as detected by the fluorescent labelling, no quantitative reduction in *S. mutans* GS5 was observed. It seemed that the other pioneer species of mixed biofilm, the *A. oris* or *V. parvula*, may affect eDNA, and interfere with the colonisation of *S. mutans* GS5. Furthermore, assessment is required to measure the amount of eDNA in both biofilms with wild-type *S. gordonii* DL1 and mutant *S. gordonii* *ssnA*, to compare them to see if there is a difference that may influence the colonisation of *S. mutans* GS5.

In conclusion, the developed mixed species biofilm models from early colonisers, whether with wild-type *S. gordonii* DL1 or mutant *S. gordonii* *ssnA*, were reproducible and stable to challenge with another bacterial species, regardless of the presence or absence of sucrose. A Modified Robbins Device was found to be a suitable system for developing mono and mixed culture biofilms, but it has some limitations as it is relatively laborious to set up and is prone to contamination. Both *S. mutans* strains (UA159 and GS5) showed their ability to incorporate within the preformed biofilm, but with significant differences between their numbers, indicating the presence of variation between different *S. mutans* strains even though they were both serotype c. Therefore, this work has established a model for investigating the colonisation of pre-existing biofilms by *S. mutans*. The system developed here can be used in future to identify the key molecular mechanisms that underpin the integration of *S. mutans* into biofilms.



## 6.2 Suggestions for Future Work

The continuous addition of 0.1% sucrose to mixed species biofilm challenged with *S. mutans* did not affect *S. mutans* colonisation within the biofilms, although the presence of sucrose is considered to be important for *S. mutans* growth (Shumi *et al.*, 2010). It is possible that 0.1% sucrose was insufficient to see an impact on biofilm development. Higher concentrations were avoided due to problems with occlusion of the tubing in the model (Yassin *et al.*, 2016). One approach to study higher sucrose concentrations would be to pulse sucrose at intervals, roughly mimicking the dietary intake of meals or snacks. Similar approaches could then be employed to investigate the effects of different carbohydrate sources on the colonisation of pre-existing biofilms by *S. mutans*.

Using MRD permits the periodic collection of samples at different time points via the availability of separate biostuds (Coenye and Nelis, 2010). Therefore, in future work, when challenging the preformed early colonisers mixed species biofilm with *S. mutans*, the MRD can be kept running for a longer period than 24 h, alongside periodic assessment, to mix biofilms and potentially show the difference in colonisation of *S. mutans* at different stages of incorporation within the preformed biofilms. For example, sampling within 2 h of *S. mutans* inoculation would enable assessment of initial adhesion, whereas longer time courses over several days would allow the monitoring of growth and the impact of competition between *S. mutans* and the early colonisers on the microbial composition of the biofilm. Techniques to enumerate viable cells such as vitality qPCR will be important when looking at longer time frames, where there is significant potential for cell death since qPCR alone is not a good measure for cell death.

Different Mutans and non-mutans bacterial species have been associated with dental caries at different stages of disease development. *S. sobrinus*, a Mutans species, was mostly linked to ECC, in addition to *S. mutans* (Okada *et al.*, 2012), while *Scardovia wiggsiae*, a non-mutans species, was associated with initial white spot carious lesions (Tanner, 2015), as well ECC carious lesions (Tanner *et al.*, 2011b). In this study, *S. mutans* showed their ability to incorporate the preformed early colonisers mixed species biofilms. The preformed biofilm could also be challenged with other potentially cariogenic bacterial species such as *S. sobrinus* or *S. wiggsiae* to investigate how they incorporate within the biofilm. This may provide insights into how different cariogenic bacterial species behave within the early colonisers biofilm model.

The significant differences demonstrated between different *S. mutans* strains (UA159 and GS5) when challenged in the preformed mixed species biofilms are possibly linked to the mutation in *pac* and *gbpC* genes shown in *S. mutans* GS5 (Shields, 2014), but not in *S. mutans* UA159 (Ajdić *et al.*, 2002). Both Pac and GbpC aid bacterial adhesion to a surface, and may be important for biofilm establishment (Murakami *et al.*, 1997; Sato *et al.*, 2002). At the same time, although *S. mutans* GS5 lacks these genes, they were still able at some extent to colonise within the preformed mixed biofilm. Thus, future work may be suggested here to investigate two issues:

Firstly, a study may knock out these genes *pac* and *gbpC* from *S. mutans* UA159, to challenge the preformed mixed species biofilm with wild-type *S. mutans* UA159 and the mutant *S. mutans* UA159; the effect of this on their colonisation ability can thus be assessed.

Secondly, as these genes' mutation in *S. mutans* GS5 did not affect their colonisation, the possibility that other key genes are involved in bacterial colonisation such as *gbpA* or *gbpB* (Lynch *et al.*, 2007; Lynch *et al.*, 2013) requires further research.

In this study, *S. mutans* GS5 in mixed species biofilm did not seem to be sensitive to DNase, and it was able to colonise within the biofilm with wild-type *S. gordonii* DL1. This is in contrast to previous experiments that showed higher sensitivity of *S. mutans* GS5 monoculture biofilms to SsnA (Shields, 2014). At the same time, although eDNA of the biofilm matrix has been demonstrated to be important for *S. mutans* colonisation (Das *et al.*, 2010), in this study, despite the clear presentation of eDNA in biofilm matrix of mixed biofilm with mutant *S. gordonii* *ssnA*, the colonisation of *S. mutans* GS5 was not affected by *S. gordonii* *ssnA* gene disruption. Further future work is required to understand such an unexpected GS5 colonisation response in mixed species biofilm. One approach would be to develop an initial biofilm of *S. gordonii* DL1 and *S. gordonii* *ssnA* without the other pioneer bacterial species *A. oris* and *V. parvula*, since these species may themselves modulate the amount of eDNA in the biofilm matrix. Comparing the colonisation of *S. mutans* GS5 within these biofilms, as well as the amount of eDNA, may give an idea of the effect of DNase and eDNA presentation on *S. mutans* GS5 colonisation, in addition to determining if the absence of other pioneer species may have an effect on DNase activity and eDNA within the biofilms.

## Appendix

### *Appendix A: Conference and meeting attendance, and public engagement*

International Association for Dental Research General Session, Boston – Massachusetts, USA, 11th-14th March 2015 (Poster).

Title: Mechanisms of Biofilm Formation by *Streptococcus mutans*

Abstracts:

Objectives: Dental plaque is a mixed-species microbial biofilm on tooth surfaces that forms initially by the colonisation of specialized bacteria, and matures into a highly organised community. The integration and overgrowth of acidogenic bacteria in dental plaque can lead to the development of dental caries. Here, we describe the establishment of a robust model mixed-species biofilm of initial colonizers that can be used to study the integration of later colonizers such as *Streptococcus mutans*.

Methods: Quantitative PCR was developed for *Streptococcus gordonii* DL1, *Actinomyces oris* MG1 and *Veillonella* sp. PK1910 in order to quantify individual species within a mixed-species model. Biofilms containing the three species were developed on saliva-coated surfaces under fluid flow in a Modified Robbins Device system.

Results: Individual quantitative PCR assays were developed that were specific for *S. gordonii*, *A. oris*, and *Veillonella* sp. Biofilms containing all three species were developed in the Modified Robbins Device and were shown to be reproducible and stable.

Conclusions: A model of mixed-species oral biofilms has been established that will enable the study of mechanisms responsible for integration by later colonizing bacteria. This model will now be used to assess the ability of different strains of *S. mutans* to integrate into pre-established biofilms.



# Mechanisms of Biofilm Formation by *Streptococcus mutans*

#4338



S.W. Al-Osaighari\*, P. Waterhouse, N. Jakubovics  
School of Dental Sciences, Newcastle University, UK  
email: s.w.a.al-osaighari@newcastle.ac.uk



## Introduction

- Dental plaque is a mixed-species microbial biofilm that accumulates on tooth surfaces.
- It is formed initially by the adhesion of primary coloniser, and further matures into a highly organised community.
- The integration and overgrowth of acidogenic bacteria in dental plaque can potentially lead to dental caries.

## Aims

- To establish a model of mixed-species biofilms of primary coloniser.
- Assess the impact of sucrose on the *Streptococcus mutans* into this biofilm.

## Methods

- Develop specific qPCR protocols for the enumeration of *Streptococcus gordonii*, *Actinomyces oris*, *Veillonella* sp., and *Streptococcus mutans*.
- Develop 'primary coloniser' biofilms of *S.gordonii* DLI, *A.oris* MG1, and *Veillonella* sp. PK1910 under fluid flow in a Modified Robbins Device (MRD).
- Quantify each individual species within a mixed-species biofilm model by qPCR.
- Image the mixed-species initial biofilm models by Scanning Electron Microscopy (SEM).



Modified Robbins Device (MRD) in the 37°C incubator

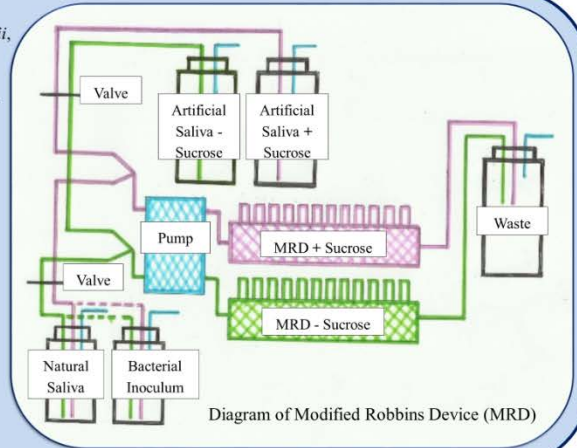

## Results

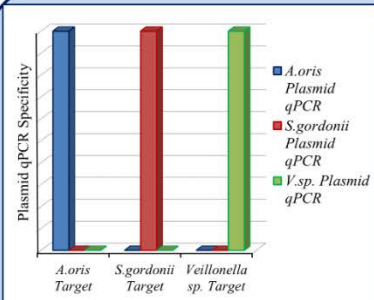

qPCR to check the specificity of each target against other bacterial species.

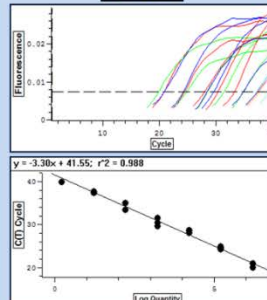

Example of qPCR curves to quantify individual species within a mixed-species biofilm model.

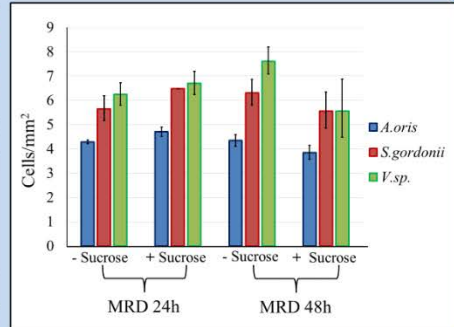

qPCR quantification of bacterial cells/mm²

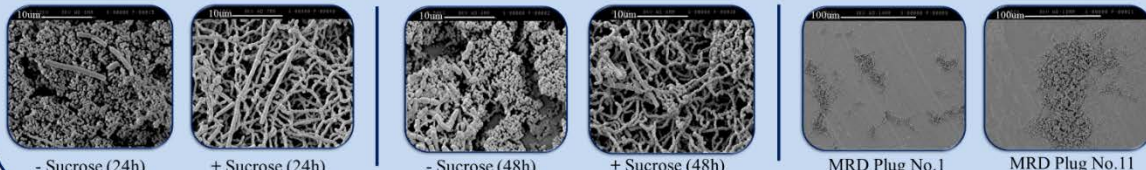

SEM of mixed-species initial biofilm model

## Conclusions

- A model of mixed-species primary coloniser oral biofilms has been developed.
- All species grew well, although *S.gordonii* and *Veillonella* sp. dominated at both 24h and 48h.
- Sucrose had relatively minor effect on the biofilm structure or composition.
- SEM images showed variation in biofilms at different positions in MRD. The biofilm tended to colonise more heavily towards the outlet of MRD.

## Future Work

- Assess the ability of different strains of *Streptococcus mutans* to integrate into pre-established primary coloniser mixed-species biofilms.

## References

- Hojjo *et al.*, 2009, Marsh, 2004, Fejerskov and Kidd, 2008, Cheon *et al.*, 2013.

OMIG Scientific Meeting, Newtown, Wales. 9th-11th March 2016 (Poster).

Title: Mechanisms of biofilm formation by *Streptococcus mutans*

Abstract:

Objectives: Dental plaque forms on freshly cleaned tooth surfaces, initially with the attachment of pioneer colonisers such as *Streptococci*, *Actinomyces* and *Veillonellae*. Subsequent biofilm growth, and the integration of later colonising acidogenic bacteria such as *Streptococcus mutans*, can ultimately lead to the development of carious lesions. Here, we describe the development of a new model system for assessing the incorporation of *Streptococcus mutans* into a pre-existing biofilm formed by three early colonisers.

Methods: The Modified Robbins Device (MRD) was used to develop mixed species biofilms from the pioneer colonisers *S.gordonii* DL1, *Actinomyces oris* MG1, and *Veillonella* sp. PK1910 on saliva-coated surfaces. Quantitative PCR was used to quantify bacterial cells, and biofilms were imaged by scanning electron microscopy (SEM). These biofilms were challenged with *S. mutans* in the presence or absence of added sucrose. In addition to qPCR and SEM, *S. mutans* was visualised in the biofilms using fluorescence in situ hybridisation (FISH).

Results: Early biofilms were dominated by *Veillonella* sp. and *S. gordonii*, but *A. oris* was clearly detectable, by qPCR and SEM. Addition of sucrose had no effect on the composition or structure of early biofilms. *S. mutans* became incorporated into biofilms and was detected by qPCR and FISH. Sucrose did not affect the numbers of *S. mutans* colonising, but resulted in changes in the matrix structure.

Conclusions: A model of mixed-species oral biofilms has been established that will enable further studies on the mechanisms responsible for integration of *S. mutans* into pre-existing biofilms. This model will now be further characterised using fluorescent dyes to visualise polysaccharides and extracellular DNA in the matrices of biofilms.



# Mechanisms of Biofilm Formation by *Streptococcus mutans*

S.W. Al-Osaighari\*, P. Waterhouse, N. Jakubovics  
 School of Dental Sciences, Newcastle University, UK  
 email: s.w.a.al-osaighari@newcastle.ac.uk



## Aims

- To establish a model of mixed-species biofilms by primary coloniser soft dental plaque.
- Assess the incorporation of *Streptococcus mutans* into pre-existing biofilms formed by three early colonisers.

## Introduction

- Dental plaque forms on freshly cleaned tooth surfaces.
- It forms initially by the attachment of pioneer colonisers such as streptococci, actinomyces and veillonellae.
- The integration of later colonising acidogenic bacteria such as *Streptococcus mutans*, can ultimately lead to the development of carious lesions.

## Methods

- Develop 'primary coloniser' biofilms of *S.gordonii* DL1, *A.oris* MG1, and *Veillonella parvula* PK1910 under fluid flow in a Modified Robbins Device (MRD).
  - Quantify each species by qPCR.
  - Image biofilms by scanning electron microscopy (SEM).
- Inoculate *S.mutans* UA159 onto primary coloniser biofilms.
  - Quantify the *S.mutans* within the biofilm by qPCR.
  - Imaging by SEM.
  - Visualise *S.mutans* in the biofilm by fluorescence in situ hybridisation (FISH).

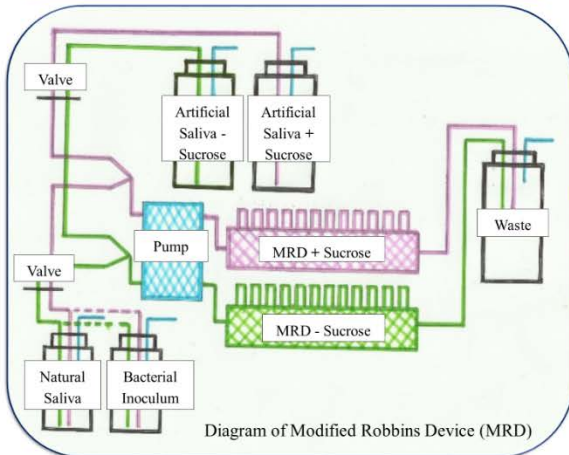

Modified Robbins Device (MRD) in the 37°C incubator

## Results

### qPCR quantification of bacterial cells/mm<sup>2</sup>

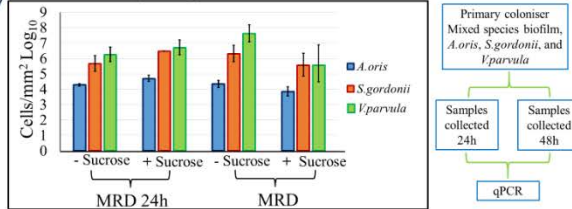

### SEM of mixed-species primary coloniser biofilms

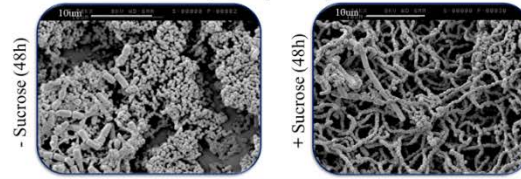

### qPCR quantification of *S.mutans* bacterial cells/mm<sup>2</sup>

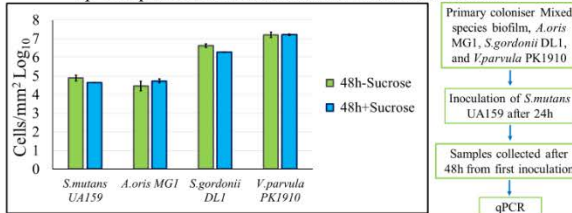

### SEM of *S.mutans* mixed-species biofilm model



### Detection of *S.mutans* in mixed-species biofilm by FISH

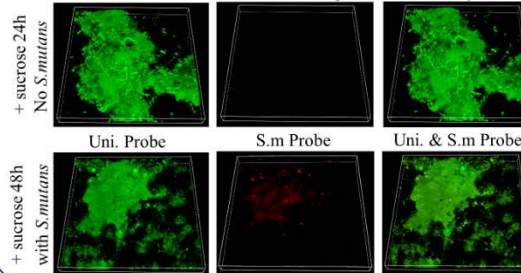

## Conclusions

- Early biofilms were dominated by *V. parvula*, and *S. gordonii*, but *A. oris* was clearly detectable by qPCR, and SEM.
- Addition of sucrose had no effect on the composition or structure of early biofilms.
- Sucrose did not affect the numbers of *S. mutans* colonising, but resulted in changes in the matrix structure, observed by SEM.
- FISH demonstrated that *S. mutans* became incorporated into biofilms.

## Reference

- Aas, J.A., Griffen, A.L., Dardis, S.R., Lee, A.M., Olsen, I., Dewhirst, F.E., Leys, E.J. and Paster, B.J. (2008) 'Bacteria of Dental Caries in Primary and Permanent Teeth in Children and Young Adults', *Journal of Clinical Microbiology*, 46(4), pp. 1407-1417.
- Ahn, S.-J. and Burne, R.A. (2007) 'Effects of oxygen on biofilm formation and the AtlA autolysin of *Streptococcus mutans*', *Journal of Bacteriology*, 189(17), pp. 6293-6302.
- Ahovuo-Saloranta, A., Forss, H., Hiiri, A., Nordblad, A. and Mäkelä, M. (2016) 'Pit and fissure sealants versus fluoride varnishes for preventing dental decay in the permanent teeth of children and adolescents', *Cochrane Database of Systematic Reviews*, (1), pp. 1-29.
- Ahovuo-Saloranta, A., Forss, H., Walsh, T., Hiiri, A., Nordblad, A., Mäkelä, M. and Worthington, H.V. (2013) 'Sealants for preventing dental decay in the permanent teeth', *Cochrane Database of Systematic Reviews*, (3), pp. 1-39.
- Ajdić, D., McShan, W.M., McLaughlin, R.E., Savić, G., Chang, J., Carson, M.B., Primeaux, C., Tian, R., Kenton, S., Jia, H., Lin, S., Qian, Y., Li, S., Zhu, H., Najar, F., Lai, H., White, J., Roe, B.A. and Ferretti, J.J. (2002) 'Genome sequence of *Streptococcus mutans* UA159, a cariogenic dental pathogen', *Proceedings of the National Academy of Sciences*, 99(22), pp. 14434-14439.
- Al-Ahmad, A., Follo, M., Selzer, A.-C., Hellwig, E., Hannig, M. and Hannig, C. (2009) 'Bacterial colonization of enamel in situ investigated using fluorescence in situ hybridization', *Journal of Medical Microbiology*, 58(10), pp. 1359-1366.
- Al-Ahmad, A., Wiedmann-Al-Ahmad, M., Faust, J., Bächle, M., Follo, M., Wolkewitz, M., Hannig, C., Hellwig, E., Carvalho, C. and Kohal, R. (2010) 'Biofilm formation and composition on different implant materials in vivo', *Journal of Biomedical Materials Research Part B: Applied Biomaterials*, 95(1), pp. 101-109.
- Allaker, R.P. and Douglas, C.W.I. (2009) 'Novel anti-microbial therapies for dental plaque-related diseases', *International Journal of Antimicrobial Agents*, 33(1), pp. 8-13.
- Allison, D.G. (2003) 'The biofilm matrix', *Biofouling*, 19(2), pp. 139-150.

Àlvarez, G., González, M., Isabal, S., Blanc, V. and León, R. (2013) 'Method to quantify live and dead cells in multi-species oral biofilm by real-time PCR with propidium monoazide', *AMB Express*, 3(1), p. 1.

Amann, R.I., Binder, B.J., Olson, R.J., Chisholm, S.W., Devereux, R. and Stahl, D.A. (1990) 'Combination of 16S rRNA-targeted oligonucleotide probes with flow cytometry for analyzing mixed microbial populations', *Applied and Environmental Microbiology*, 56(6), pp. 1919-1925.

Ammann, T.W., Bostanci, N., Belibasakis, G.N. and Thurnheer, T. (2013) 'Validation of a quantitative real-time PCR assay and comparison with fluorescence microscopy and selective agar plate counting for species-specific quantification of an in vitro subgingival biofilm model', *Journal of Periodontal Research*, 48(4), pp. 517-526.

Aoba, T. (2004) 'Solubility properties of human tooth mineral and pathogenesis of dental caries', *Oral Diseases*, 10(5), pp. 249-257.

Arrieta, M.-C., Stiemsma, L.T., Amenyogbe, N., Brown, E.M. and Finlay, B. (2014) 'The Intestinal Microbiome in Early Life: Health and Disease', *Frontiers in Immunology*, 5(427), pp. 1-18.

Arthur, R.A., Waeiss, R.A., Hara, A.T., Lippert, F., Eckert, G.J. and Zero, D.T. (2013) 'A defined-multispecies microbial model for studying enamel caries development', *Caries Research*, 47(4), pp. 318-324.

Atkinson, J.C. and Baum, B.J. (2001) 'Salivary enhancement: current status and future therapies', *Journal of Dental Education*, 65(10), pp. 1096-1101.

Bader, J.D., Vollmer, W.M., Shugars, D.A., Gilbert, G.H., Amaechi, B.T., Brown, J.P., Laws, R.L., Funkhouser, K.A., Makhija, S.K., Ritter, A.V. and Leo, M.C. (2013) 'Results from the Xylitol for Adult Caries Trial (X-ACT)', *Journal of the American Dental Association (1939)*, 144(1), pp. 21-30.



- Bagge, D., Hjelm, M., Johansen, C., Huber, I. and Gram, L. (2001) 'Shewanella putrefaciens adhesion and biofilm formation on food processing surfaces', *Applied and Environmental Microbiology*, 67(5), pp. 2319-2325.
- Baker, J.L., Faustoferri, R.C. and Quivey, R.G. (2016) 'Acid-adaptive mechanisms of Streptococcus mutans—the more we know, the more we don't', *Molecular Oral Microbiology*, 32(2), pp. 107-117.
- Balakrishnan, M., Simmonds, R.S. and Tagg, J.R. (2000) 'Dental caries is a preventable infectious disease', *Australian Dental Journal*, 45(4), pp. 235-245.
- Banas, J.A. (2004) 'Virulence properties of Streptococcus mutans', *Front Biosciences*, 9(10), pp. 1267-77.
- Banas, J.A. and Vickerman, M.M. (2003) 'Glucan-binding Proteins of the Oral Streptococci', *Critical Reviews in Oral Biology & Medicine*, 14(2), pp. 89-99.
- Bayles, K.W. (2007) 'The biological role of death and lysis in biofilm development', *Nature Reviews Microbiology*, 5(9), pp. 721-726.
- Becker, M.R., Paster, B.J., Leys, E.J., Moeschberger, M.L., Kenyon, S.G., Galvin, J.L., Boches, S.K., Dewhirst, F.E. and Griffen, A.L. (2002) 'Molecular Analysis of Bacterial Species Associated with Childhood Caries', *Journal of Clinical Microbiology*, 40(3), pp. 1001-1009.
- Beighton, D. (2005) 'The complex oral microflora of high-risk individuals and groups and its role in the caries process', *Community Dentistry and Oral Epidemiology*, 33(4), pp. 248-255.
- Bergeron, L.J. and Burne, R.A. (2001) 'Roles of Fructosyltransferase and Levanase-Sucrase of Actinomyces naeslundii in Fructan and Sucrose Metabolism', *Infection and Immunity*, 69(9), pp. 5395-5402.
- Berne, C., Kysela, D.T. and Brun, Y.V. (2010) 'A bacterial extracellular DNA inhibits settling of motile progeny cells within a biofilm', *Molecular Microbiology*, 77(4), pp. 815-829.

- Biswas, S. and Biswas, I. (2005) 'Role of HtrA in Surface Protein Expression and Biofilm Formation by *Streptococcus mutans*', *Infection and Immunity*, 73(10), pp. 6923-6934.
- Biswas, S. and Biswas, I. (2012) 'Complete Genome Sequence of *Streptococcus mutans* GS-5, a Serotype c Strain', *Journal of Bacteriology*, 194(17), pp. 4787-4788.
- Blackman, S.A., Smith, T.J. and Foster, S.J. (1998) 'The role of autolysins during vegetative growth of *Bacillus subtilis* 168', *Microbiology*, 144(1), pp. 73-82.
- Bladen, H.A. and Mergenhagen, S.E. (1964) 'Ultrastructure of *Veillonella* and Morphological Correlation of Outer Membrane with Particles Associated with Endotoxic Activity ', *Journal of Bacteriology*, 88(5), pp. 1482-1492.
- Blanc, V., Isabal, S., Sanchez, M., Llama-Palacios, A., Herrera, D., Sanz, M. and León, R. (2014) 'Characterization and application of a flow system for in vitro multispecies oral biofilm formation', *Journal of Periodontal Research*, 49(3), pp. 323-332.
- Bowden, G.H.W. and Li, Y.H. (1997) 'Nutritional influences on biofilm development', *Advances in Dental Research*, 11(1), pp. 81-99.
- Bowen, W.H. (2002) 'Do we need to be concerned about dental caries in the coming millennium?', *Critical Reviews in Oral Biology & Medicine*, 13(2), pp. 126-131.
- Bowen, W.H. and Koo, H. (2011) 'Biology of *Streptococcus mutans*-Derived Glucosyltransferases: Role in Extracellular Matrix Formation of Cariogenic Biofilms', *Caries Research*, 45(1), pp. 69-86.
- Bowen, W.H., Madison, K.M. and Pearson, S.K. (1988a) 'Influence of Desalivation in Rats on Incidence of Caries in Intact Cagemates', *Journal of Dental Research*, 67(10), pp. 1316-1318.
- Bowen, W.H., Pearson, S.K. and Young, D.A. (1988b) 'The Effect of Desalivation on Coronal and Root Surface Caries in Rats', *Journal of Dental Research*, 67(1), pp. 21-23.

Bowen, W.H., Schilling, K., Giertsen, E., Pearson, S., Lee, S.F., Bleiweis, A. and Beeman, D. (1991) 'Role of a cell surface-associated protein in adherence and dental caries', *Infection and Immunity*, 59(12), pp. 4606-4609.

Bradshaw, D.J., Marsh, P.D., Watson, G.K. and Allison, C. (1998) 'Role of *Fusobacterium nucleatum* and Coaggregation in Anaerobe Survival in Planktonic and Biofilm Oral Microbial Communities during Aeration', *Infection and Immunity*, 66(10), pp. 4729-4732.

Brailsford, S.R., Shah, B., Simons, D., Gilbert, S., Clark, D., Ines, I., Adams, S.E., Allison, C. and Beighton, D. (2001) 'The predominant aciduric microflora of root-caries lesions', *Journal of Dental Research*, 80(9), pp. 1828-1833.

Branda, S.S., Vik, Å., Friedman, L. and Kolter, R. (2005) 'Biofilms: the matrix revisited', *Trends in Microbiology*, 13(1), pp. 20-26.

Burne, R.A. and Marquis, R.E. (2000) 'Alkali production by oral bacteria and protection against dental caries', *FEMS Microbiology Letters*, 193(1), pp. 1-6.

Cagetti, M.G., Campus, G., Sale, S., Cocco, F., Strohmer, L. and Lingström, P. (2011) 'Association between interdental plaque acidogenicity and caries risk at surface level: a cross sectional study in primary dentition', *International Journal of Paediatric Dentistry*, 21(2), pp. 119-125.

Cangelosi, G.A. and Meschke, J.S. (2014) 'Dead or alive: molecular assessment of microbial viability', *Applied and Environmental Microbiology*, 80(19), pp. 5884-5891.

Carey, C.M. (2014) 'Focus on Fluorides: Update on the Use of Fluoride for the Prevention of Dental Caries', *Journal of Evidence Based Dental Practice*, 14, pp. 95-102.

Casamassimo, P.S., Thikkurissy, S., Edelstein, B.L. and Maiorini, E. (2009) 'Beyond the dmft', *The Journal of the American Dental Association*, 140(6), pp. 650-657.

Catalán, M.A., Scott-Anne, K., Klein, M.I., Koo, H., Bowen, W.H. and Melvin, J.E. (2011) 'Elevated Incidence of Dental Caries in a Mouse Model of Cystic Fibrosis', *PLoS ONE*, 6(1), p. e16549.

- Catlin, B.W. and Cunningham, L.S. (1958) 'Studies of Extracellular and Intracellular Bacterial Deoxyribonucleic Acids', *Microbiology*, 19(3), pp. 522-539.
- Caufield, P.W., Cutter, G.R. and Dasanayake, A.P. (1993) 'Initial Acquisition of Mutans Streptococci by Infants: Evidence for a Discrete Window of Infectivity', *Journal of Dental Research*, 72(1), pp. 37-45.
- Cephas, K.D., Kim, J., Mathai, R.A., Barry, K.A., Dowd, S.E., Meline, B.S. and Swanson, K.S. (2011) 'Comparative Analysis of Salivary Bacterial Microbiome Diversity in Edentulous Infants and Their Mothers or Primary Care Givers Using Pyrosequencing', *PLoS ONE*, 6(8), p. e23503.
- Ceri, H., Olson, M.E., Stremick, C., Read, R.R., Morck, D. and Buret, A. (1999) 'The Calgary Biofilm Device: new technology for rapid determination of antibiotic susceptibilities of bacterial biofilms', *Journal of Clinical Microbiology*, 37(6), pp. 1771-1776.
- Chen, F. and Wang, D. (2010) 'Novel technologies for the prevention and treatment of dental caries: a patent survey', *Expert Opinion on Therapeutic Patents*, 20(5), pp. 681-694.
- Chen, H. and Jiang, W. (2014) 'Application of high-throughput sequencing in understanding human oral microbiome related with health and disease', *Recent Discoveries in Evolutionary and Genomic Microbiology*, p. 76.
- Childers, N.K., Osgood, R.C., Hsu, K.L., Manmontri, C., Momeni, S.S., Mahtani, H., Cutter, G.R. and Ruby, J.D. (2011) 'Real-Time Quantitative Polymerase Chain Reaction for Enumeration of Streptococcus mutans from Oral Samples', *European Journal of Oral Sciences*, 119(6), pp. 447-454.
- Chou, R., Cantor, A., Zakher, B., Mitchell, J.P. and Pappas, M. (2013) 'Preventing of dental caries in children younger than 5 Years', *Pediatrics*, 132(2), pp. 332-350.
- Ciric, L., Pratten, J., Wilson, M. and Spratt, D. (2010) 'Development of a novel multi-triplex qPCR method for the assessment of bacterial community structure in oral populations', *Environmental Microbiology Reports*, 2(6), pp. 770-774.

Clarke, J.K. (1924) 'On the Bacterial Factor in the Ætiology of Dental Caries', *British Journal of Experimental Pathology*, 5(3), pp. 141-147.

Coenye, T., De Prijck, K., De Wever, B. and Nelis, H.J. (2008) 'Use of the modified Robbins device to study the in vitro biofilm removal efficacy of NitrAdine™, a novel disinfecting formula for the maintenance of oral medical devices', *Journal of Applied Microbiology*, 105(3), pp. 733-740.

Coenye, T. and Nelis, H.J. (2010) 'In vitro and in vivo model systems to study microbial biofilm formation', *Journal of Microbiological Methods*, 83(2), pp. 89-105.

Costello, E.K., Stagaman, K., Dethlefsen, L., Bohannan, B.J.M. and Relman, D.A. (2012) 'The Application of Ecological Theory Toward an Understanding of the Human Microbiome', *Science*, 336(6086), p. 1255.

Costerton, J.W., Stewart, P.S. and Greenberg, E.P. (1999) 'Bacterial biofilms: a common cause of persistent infections', *Science*, 284(5418), pp. 1318-1322.

Crielaard, W., Zaura, E., Schuller, A.A., Huse, S.M., Montijn, R.C. and Keijsers, B.J. (2011) 'Exploring the oral microbiota of children at various developmental stages of their dentition in the relation to their oral health', *BMC Medical Genomics*, 4(1), p. 22.

Cross, B., Garcia, A., Faustoferri, R. and Quivey, R.G. (2016) 'PlsX deletion impacts fatty acid synthesis and acid adaptation in *Streptococcus mutans*', *Microbiology*, 162(4), pp. 662-671.

Crowley, P.J., Brady, L.J., Michalek, S.M. and Bleiweis, A.S. (1999) 'Virulence of a spaP Mutant of *Streptococcus mutans* in a Gnotobiotic Rat Model', *Infection and Immunity*, 67(3), pp. 1201-1206.

Cummins, D. (2013) 'The development and validation of a new technology, based upon 1.5% arginine, an insoluble calcium compound and fluoride, for everyday use in the prevention and treatment of dental caries', *Journal of Dentistry*, 41, pp. S1-S11.

Cvitkovitch, D.G., Li, Y.-H. and Ellen, R.P. (2003) 'Quorum sensing and biofilm formation in Streptococcal infections', *The Journal of Clinical Investigation*, 112(11), pp. 1626-1632.

Das, T., Krom, B.P., van der Mei, H.C., Busscher, H.J. and Sharma, P.K. (2011) 'DNA-mediated bacterial aggregation is dictated by acid–base interactions', *Soft Matter*, 7(6), pp. 2927-2935.

Das, T., Sharma, P.K., Busscher, H.J., van der Mei, H.C. and Krom, B.P. (2010) 'Role of extracellular DNA in initial bacterial adhesion and surface aggregation', *Applied and Environmental Microbiology*, 76(10), pp. 3405-3408.

Dawes, C. (2003) 'What is the critical pH and why does a tooth dissolve in acid?', *Journal-Canadian Dental Association*, 69(11), pp. 722-725.

De Soet, J., Nyvad, B. and Kilian, M. (2000) 'Strain–Related Acid Production by Oral Streptococci', *Caries Research*, 34(6), pp. 486-490.

Decker, E.-M., Klein, C., Schwindt, D. and von Ohle, C. (2014) 'Metabolic activity of *Streptococcus mutans* biofilms and gene expression during exposure to xylitol and sucrose', *International Journal of Oral Science*, 6, p. 195.

Del Chierico, F., Ancora, M., Marcacci, M., Camma, C., Putignani, L. and Conti, S. (2015) *Choice of Next-Generation Sequencing Pipelines*, 1231, pp. 31-47.

Delima, S.L., McBride, R.K., Preshaw, P.M., Heasman, P.A. and Kumar, P.S. (2010) 'Response of subgingival bacteria to smoking cessation', *Journal of Clinical Microbiology*, 48(7), pp. 2344-2349.

Dell, Anno, A. and Danovaro, R. (2005) 'Extracellular DNA Plays a Key Role in Deep-Sea Ecosystem Functioning', *Science*, 309(5744), p. 2179.

Dewhirst, F.E., Chen, T., Izard, J., Paster, B.J., Tanner, A.C.R., Yu, W.-H., Lakshmanan, A. and Wade, W.G. (2010) 'The human oral microbiome', *Journal of Bacteriology*, 192(19), pp. 5002-5017.

- Dige, I., Nyengaard, J.R., Kilian, M. and Nyvad, B. (2009) 'Application of stereological principles for quantification of bacteria in intact dental biofilms', *Oral Microbiology and Immunology*, 24(1), pp. 69-75.
- Dominguez-Bello, M.G., Costello, E.K., Contreras, M., Magris, M., Hidalgo, G., Fierer, N. and Knight, R. (2010) 'Delivery mode shapes the acquisition and structure of the initial microbiota across multiple body habitats in newborns', *Proceedings of the National Academy of Sciences*, 107(26), pp. 11971-11975.
- Donlan, R.M. and Costerton, J.W. (2002) 'Biofilms: Survival Mechanisms of Clinically Relevant Microorganisms', *Clinical Microbiology Reviews*, 15(2), pp. 167-193.
- Dufour, D., Cordova, M., Cvitkovitch, D.G. and Lévesque, C.M. (2011) 'Regulation of the Competence Pathway as a Novel Role Associated with a Streptococcal Bacteriocin', *Journal of Bacteriology*, 193(23), pp. 6552-6559.
- Dye, B.A., Hsu, K.-L.C. and Afful, J. (2015) 'Prevalence and Measurement of Dental Caries in Young Children', *Pediatric Dentistry*, 37(3), pp. 200-216.
- Edlund, A., Yang, Y., Hall, A.P., Guo, L., Lux, R., He, X., Nelson, K.E., Nealson, K.H., Yooseph, S., Shi, W. and McLean, J.S. (2013) 'An in vitro biofilm model system maintaining a highly reproducible species and metabolic diversity approaching that of the human oral microbiome', *Microbiome*, 1(1), pp. 1-17.
- Egland, P.G., Palmer, R.J. and Kolenbrander, P.E. (2004) 'Interspecies communication in *Streptococcus gordonii*-*Veillonella atypica* biofilms: Signaling in flow conditions requires juxtaposition', *Proceedings of the National Academy of Sciences of the United States of America*, 101(48), pp. 16917-16922.
- Ekstrand, K., Luna, L., Promisiero, L., Cortes, A., Cuevas, S., Reyes, J., Torres, C. and Martignon, S. (2011) 'The reliability and accuracy of two methods for proximal caries detection and depth on directly visible proximal surfaces: an in vitro study', *Caries Research*, 45(2), pp. 93-99.

Elizaquível, P., Aznar, R. and Sánchez, G. (2014) 'Recent developments in the use of viability dyes and quantitative PCR in the food microbiology field', *Journal of Applied Microbiology*, 116(1), pp. 1-13.

Falsetta, M.L., Klein, M.I., Lemos, J.A., Silva, B.B., Agidi, S., Scott-Anne, K.K. and Koo, H. (2012) 'Novel antibiofilm chemotherapy targets exopolysaccharide synthesis and stress tolerance in *Streptococcus mutans* to modulate virulence expression in vivo', *Antimicrobial Agents and Chemotherapy*, 56(12), pp. 6201-6211.

Featherstone, J.D.B. (2004) 'The continuum of dental caries—evidence for a dynamic disease process', *Journal of Dental Research*, 83(suppl 1), pp. C39-C42.

Featherstone, J.D.B. (2008) 'Dental caries: a dynamic disease process', *Australian Dental Journal*, 53(3), pp. 286-291.

Feigal, R.J. (2002) 'The use of pit and fissure sealants', *Pediatric Dentistry*, 24(5), pp. 415-422.

Feigal, R.J. and Donly, K.J. (2006) 'The Use of Pit and Fissure Sealants', *Pediatric Dentistry*, 28(2), pp. 143-150.

Fejerskov, O. (2004) 'Changing Paradigms in Concepts on Dental Caries: Consequences for Oral Health Care', *Caries Research*, 38(3), pp. 182-191.

Finkel, S.E. and Kolter, R. (2001) 'DNA as a nutrient: novel role for bacterial competence gene homologs', *Journal of Bacteriology*, 183(21), pp. 6288-6293.

Fitzgerald, R.J. and Keyes, P.H. (1963) 'Ecologic Factors in Dental Caries: The Fate of Antibiotic-Resistant Cariogenic *Streptococci* in Hamsters', *The American Journal of Pathology*, 42(6), pp. 759-772.

Flemming, H.-C. and Wingender, J. (2010) 'The biofilm matrix', *Nature Reviews Microbiology*, 8(9), pp. 623-633.



Fontana, M., Young, D.A., Wolff, M.S., Pitts, N.B. and Longbottom, C. (2010) 'Defining dental caries for 2010 and beyond', *Dental Clinics of North America*, 54(3), pp. 423-440.

Forssten, S.D., Björklund, M. and Ouwehand, A.C. (2010) 'Streptococcus mutans, Caries and Simulation Models', *Nutrients*, 2(3), p. 290.

Fozo, E.M. and Quivey, R.G. (2004) 'Shifts in the Membrane Fatty Acid Profile of Streptococcus mutans Enhance Survival in Acidic Environments', *Applied and Environmental Microbiology*, 70(2), pp. 929-936.

Fozo, E.M., Scott-Anne, K., Koo, H. and Quivey, R.G. (2007) 'Role of unsaturated fatty acid biosynthesis in virulence of Streptococcus mutans', *Infection and Immunity*, 75(3), pp. 1537-1539.

Frencken, J.E., Peters, M.C., Manton, D.J., Leal, S.C., Gordan, V.V. and Eden, E. (2012) 'Minimal intervention dentistry for managing dental caries – a review', *International Dental Journal*, 62(5), pp. 223-243.

Fu, D., Pei, D., Huang, C., Liu, Y., Du, X. and Sun, H. (2013) 'Effect of desensitising paste containing 8% arginine and calcium carbonate on biofilm formation of Streptococcus mutans in vitro', *Journal of Dentistry*, 41(7), pp. 619-627.

Furiga, A., Roques, C. and Badet, C. (2014) 'Preventive effects of an original combination of grape seed polyphenols with amine fluoride on dental biofilm formation and oxidative damage by oral bacteria', *Journal of Applied Microbiology*, 116(4), pp. 761-771.

Gaffar, A., Afflitto, J. and Nabi, N. (1997) 'Chemical agents for the control of plaque and plaque microflora: an overview', *European Journal of Oral Sciences*, 105(5), pp. 502-507.

García-Caballero, L., Quintas, V., Prada-López, I., Seoane, J., Donos, N. and Tomás, I. (2013) 'Chlorhexidine substantivity on salivary flora and plaque-like biofilm: an in situ model', *PLoS ONE*, 8(12), p. e83522.

García-Godoy, F. and Hicks, M.J. (2008) 'Maintaining the integrity of the enamel surface The role of dental biofilm, saliva and preventive agents in enamel demineralization and

remineralization', *The Journal of the American Dental Association*, 139(suppl 2), pp. 25S-34S.

Gibbons, R.J. (1964) 'Bacteriology of Dental Caries', *Journal of Dental Research*, 43(1\_suppl), pp. S1021-S1028.

Giertsen, E., Arthur, R.A. and Guggenheim, B. (2011) 'Effects of xylitol on survival of mutans streptococci in mixed-six-species in vitro biofilms modelling supragingival plaque', *Caries Research*, 45(1), pp. 31-39.

Gizani, S., Papaioannou, W., Haffajee, A.D., Kavvadia, K., Quirynen, M. and Papagiannoulis, L. (2009) 'Distribution of selected cariogenic bacteria in five different intra-oral habitats in young children', *International Journal of Paediatric Dentistry*, 19(3), pp. 193-200.

Griffin, S.O., Oong, E., Kohn, W., Vidakovic, B., Gooch, B.F., Bader, J., Clarkson, J., Fontana, M.R., Meyer, D.M., Rozier, R.G., Weintraub, J.A. and Zero, D.T. (2008) 'The Effectiveness of Sealants in Managing Caries Lesions', *Journal of Dental Research*, 87(2), pp. 169-174.

Gross, E.L., Beall, C.J., Kutsch, S.R., Firestone, N.D., Leys, E.J. and Griffen, A.L. (2012) 'Beyond Streptococcus mutans: Dental Caries Onset Linked to Multiple Species by 16S rRNA Community Analysis', *PLoS ONE*, 7(10), p. e47722.

Gross, E.L., Leys, E.J., Gasparovich, S.R., Firestone, N.D., Schwartzbaum, J.A., Janies, D.A., Asnani, K. and Griffen, A.L. (2010) 'Bacterial 16S sequence analysis of severe caries in young permanent teeth', *Journal of Clinical Microbiology*, 48(11), pp. 4121-4128.

Guggenheim, B., Giertsen, E., Schüpbach, P. and Shapiro, S. (2001) 'Validation of an In vitro Biofilm Model of Supragingival Plaque', *Journal of Dental Research*, 80(1), pp. 363-370.

Guggenheim, B., Guggenheim, M., Gmür, R., Giertsen, E. and Thurnheer, T. (2004) 'Application of the Zürich biofilm model to problems of cariology', *Caries Research*, 38(3), pp. 212-222.

- Guggenheim, B. and Meier, A. (2011) 'In-vitro effect of Chlorhexidine mouth rinses on polyspecies biofilms', *Schweizer Monatsschrift fur Zahnmedizin*, 121(5), p. 432.
- Gurenlian, J.R. (2007) 'The Role of Dental Plaque Biofilm in Oral Health', *American Dental Hygienists Association*, 81(suppl 1), p. 116.
- Habimana, O., Semião, A. and Casey, E. (2014) 'The role of cell-surface interactions in bacterial initial adhesion and consequent biofilm formation on nanofiltration/reverse osmosis membranes', *Journal of Membrane Science*, 454, pp. 82-96.
- Hajishengallis, E., Parsaei, Y., Klein, M.I. and Koo, H. (2017) 'Advances in the microbial etiology and pathogenesis of early childhood caries', *Molecular Oral Microbiology*, 32(1), pp. 24-34.
- Hamada, S. and Slade, H.D. (1980) 'Biology, immunology, and cariogenicity of *Streptococcus mutans*', *Microbiological Reviews*, 44(2), pp. 331-384.
- Han, T.K., Zhang, C. and Dao, M.L. (2006) 'Identification and characterization of collagen-binding activity in *Streptococcus mutans* wall-associated protein: A possible implication in dental root caries and endocarditis', *Biochemical and Biophysical Research Communications*, 343(3), pp. 787-792.
- Han, Y.W. and Wang, X. (2013) 'Mobile microbiome oral bacteria in extra-oral infections and inflammation', *Journal of Dental Research*, 92(6), pp. 485-491.
- Hashino, E., Kuboniwa, M., Alghamdi, S.A., Yamaguchi, M., Yamamoto, R., Cho, H. and Amano, A. (2013) 'Erythritol alters microstructure and metabolomic profiles of biofilm composed of *Streptococcus gordonii* and *Porphyromonas gingivalis*', *Molecular Oral Microbiology*, 28(6), pp. 435-451.
- Hayati, F., Okada, A., Kitasako, Y., Tagami, J. and Matin, K. (2011) 'An artificial biofilm induced secondary caries model for in vitro studies', *Australian Dental Journal*, 56(1), pp. 40-47.

He, J., Hwang, G., Liu, Y., Gao, L., Kilpatrick-Liverman, L., Santarpia, P., Zhou, X. and Koo, H. (2016) 'l-Arginine Modifies the Exopolysaccharide Matrix and Thwarts *Streptococcus mutans* Outgrowth within Mixed-Species Oral Biofilms', *Journal of Bacteriology*, 198(19), pp. 2651-2661.

Hebsgaard, M.B., Phillips, M.J. and Willerslev, E. (2005) 'Geologically ancient DNA: fact or artefact?', *Trends in Microbiology*, 13(5), pp. 212-220.

Heilmann, C., Hussain, M., Peters, G. and Götz, F. (1997) 'Evidence for autolysin-mediated primary attachment of *Staphylococcus epidermidis* to a polystyrene surface', *Molecular Microbiology*, 24(5), pp. 1013-1024.

Heim, K.P., Sullan, R.M.A., Crowley, P.J., El-Kirat-Chatel, S., Beaussart, A., Tang, W., Besingi, R., Dufrene, Y.F. and Brady, L.J. (2015) 'Identification of a supramolecular functional architecture of *Streptococcus mutans* adhesin P1 on the bacterial cell surface', *Journal of Biological Chemistry*, 290(14), pp. 9002-9019.

Hentzer, M. and Givskov, M. (2004) 'Pharmacological inhibition of quorum sensing for the treatment of chronic bacterial infections', *The Journal of Clinical Investigation*, 112(9), pp. 1300-1307.

Hiiri, A., Ahovuo-Saloranta, A., Nordblad, A. and Mäkelä, M. (2010) 'Pit and fissure sealants versus fluoride varnishes for preventing dental decay in children and adolescents', *Cochrane Database Systemic Reviews*, 3(10), pp. 1-29.

Hillman, J., Brooks, T., Michalek, S., Harmon, C., Snoep, J. and van Der Weijden, C. (2000) 'Construction and characterization of an effector strain of *Streptococcus mutans* for replacement therapy of dental caries', *Infection and Immunity*, 68(2), pp. 543-549.

Hillman, J.D. (2002) 'Genetically modified *Streptococcus mutans* for the prevention of dental caries', *Antonie van Leeuwenhoek*, 82(1), pp. 361-366.

Hoiby, N., Ciofu, O., Johansen, H.K., Song, Z.-j., Moser, C., Jensen, P.Ø., Molin, S., Givskov, M., Tolker-Nielsen, T. and Bjarnsholt, T. (2011) 'The clinical impact of bacterial biofilms', *International Journal of Oral Science*, 3(2), pp. 55-65.

- Hojo, K., Nagaoka, S., Ohshima, T. and Maeda, N. (2009) 'Bacterial interactions in dental biofilm development', *Journal of Dental Research*, 88(11), pp. 982-990.
- Hope, C.K., Bakht, K., Burnside, G., Martin, G.C., Burnett, G., de Josselin de Jong, E. and Higham, S.M. (2012) 'Reducing the variability between constant-depth film fermenter experiments when modelling oral biofilm', *Journal of Applied Microbiology*, 113(3), pp. 601-608.
- Hou, Y., Zhang, H., Miranda, L. and Lin, S. (2010) 'Serious Overestimation in Quantitative PCR by Circular (Supercoiled) Plasmid Standard: Microalgal pcna as the Model Gene', *PLoS ONE*, 5(3), p. e9545.
- Houte, J.V., Upešlaciš, V.N., Jordan, H.V., Skobe, Z. and Green, D.B. (1976) 'Role of Sucrose in Colonization of Streptococcus mutans in Conventional Sprague-Dawley Rats', *Journal of Dental Research*, 55(2), pp. 202-215.
- Hu, W., Li, L., Sharma, S., Wang, J., McHardy, I., Lux, R., Yang, Z., He, X., Gimzewski, J.K., Li, Y. and Shi, W. (2012) 'DNA Builds and Strengthens the Extracellular Matrix in Myxococcus xanthus Biofilms by Interacting with Exopolysaccharides', *PLoS ONE*, 7(12), p. e51905.
- Huang, R., Li, M., Ye, M., Yang, K., Xu, X. and Gregory, R.L. (2014) 'Effects of Nicotine on Streptococcus gordonii Growth, Biofilm Formation, and Cell Aggregation', *Applied and Environmental Microbiology*, 80(23), pp. 7212-7218.
- Iheozor-Ejiofor, Z., O'Malley, L.A., Glenny, A.-M., Macey, R., Alam, R., Tugwell, P., Walsh, T., Welch, V. and Worthington, H.V. (2013) 'Water fluoridation for the prevention of dental caries', *Cochrane Database of Systematic Reviews*, (12), pp. 1-48.
- Ionescu, A., Wutscher, E., Brambilla, E., Schneider-Feyrer, S., Giessibl, F.J. and Hahnel, S. (2012) 'Influence of surface properties of resin-based composites on in vitro Streptococcus mutans biofilm development', *European Journal of Oral Sciences*, 120(5), pp. 458-465.
- Islam, B., Khan, S.N. and Khan, A.U. (2007) 'Dental caries: from infection to prevention', *Medical Science Monitor*, 13(11), pp. RA196-RA203.

Itzek, A., Zheng, L., Chen, Z., Merritt, J. and Kreth, J. (2011) 'Hydrogen peroxide-dependent DNA release and transfer of antibiotic resistance genes in *Streptococcus gordonii*', *Journal of Bacteriology*, 193(24), pp. 6912-6922.

Ivanov, Ivaylo I. and Honda, K. (2012) 'Intestinal Commensal Microbes as Immune Modulators', *Cell Host & Microbe*, 12(4), pp. 496-508.

Jain, K., Parida, S., Mangwani, N., Dash, H.R. and Das, S. (2013) 'Isolation and characterization of biofilm-forming bacteria and associated extracellular polymeric substances from oral cavity', *Annals of Microbiology*, 63(4), pp. 1553-1562.

Jakubovics, N., Shields, R., Rajarajan, N. and Burgess, J. (2013) 'Life after death: the critical role of extracellular DNA in microbial biofilms', *Letters in Applied Microbiology*, 57(6), pp. 467-475.

Jakubovics, N.S., Brittan, J.L., Dutton, L.C. and Jenkinson, H.F. (2009) 'Multiple adhesin proteins on the cell surface of *Streptococcus gordonii* are involved in adhesion to human fibronectin', *Microbiology*, 155(11), pp. 3572-3580.

Jakubovics, N.S., Gill, S.R., Vickerman, M.M. and Kolenbrander, P.E. (2008) 'Role of hydrogen peroxide in competition and cooperation between *Streptococcus gordonii* and *Actinomyces naeslundii*', *FEMS Microbiology Ecology*, 66(3), pp. 637-644.

Jakubovics, N.S., Kerrigan, S.W., Nobbs, A.H., Strömberg, N., van Dolleweerd, C.J., Cox, D.M., Kelly, C.G. and Jenkinson, H.F. (2005) 'Functions of Cell Surface-Anchored Antigen I/II Family and Hsa Polypeptides in Interactions of *Streptococcus gordonii* with Host Receptors', *Infection and Immunity*, 73(10), pp. 6629-6638.

Jakubovics, N.S. and Kolenbrander, P.E. (2010) 'The road to ruin: the formation of disease-associated oral biofilms', *Oral Diseases*, 16(8), pp. 729-739.

Jang, Y.-J., Choi, Y.-J., Lee, S.-H., Jun, H.-K. and Choi, B.-K. (2013) 'Autoinducer 2 of *Fusobacterium nucleatum* as a target molecule to inhibit biofilm formation of periodontopathogens', *Archives of Oral Biology*, 58(1), pp. 17-27.

- Jarosz, L.M., Ovchinnikova, E.S., Meijler, M.M. and Krom, B.P. (2011) 'Microbial Spy Games and Host Response: Roles of a *Pseudomonas aeruginosa* Small Molecule in Communication with Other Species', *PLoS Pathogens*, 7(11), p. e1002312.
- Jenkinson, H.F. (2011) 'Beyond the oral microbiome', *Environmental Microbiology*, 13(12), pp. 3077-3087.
- Jennings, L.K., Storek, K.M., Ledvina, H.E., Coulon, C., Marmont, L.S., Sadovskaya, I., Secor, P.R., Tseng, B.S., Scian, M. and Filloux, A. (2015) 'Pel is a cationic exopolysaccharide that cross-links extracellular DNA in the *Pseudomonas aeruginosa* biofilm matrix', *Proceedings of the National Academy of Sciences*, 112(36), pp. 11353-11358.
- Johnson, B.P., Jensen, B.J., Ransom, E.M., Heinemann, K.A., Vannatta, K.M., Eglund, K.A. and Eglund, P.G. (2009) 'Interspecies Signaling between *Veillonella atypica* and *Streptococcus gordonii* Requires the Transcription Factor CcpA', *Journal of Bacteriology*, 191(17), pp. 5563-5565.
- Jones, E.A., McGillivray, G. and Bakaletz, L.O. (2013) 'Extracellular DNA within a Nontypeable *Haemophilus influenzae*-Induced Biofilm Binds Human Beta Defensin-3 and Reduces Its Antimicrobial Activity', *Journal of Innate Immunity*, 5(1), pp. 24-38.
- Kanasi, E., Dewhirst, F.E., Chalmers, N.I., Kent, J.R., Moore, A., Hughes, C.V., Pradhan, N., Loo, C.Y. and Tanner, A.C.R. (2010) 'Clonal Analysis of the Microbiota of Severe Early Childhood Caries', *Caries Research*, 44(5), pp. 485-497.
- Kaplan, J.B. (2010) 'Biofilm Dispersal: Mechanisms, Clinical Implications, and Potential Therapeutic Uses', *Journal of Dental Research*, 89(3), pp. 205-218.
- Kara, D., Luppens, S.B.I., van Marle, J., Özok, R. and ten Cate, J.M. (2007) 'Microstructural differences between single-species and dual-species biofilms of *Streptococcus mutans* and *Veillonella parvula*, before and after exposure to chlorhexidine', *FEMS Microbiology Letters*, 271(1), pp. 90-97.
- Karpiński, T.M. and Szkaradkiewicz, A.K. (2013) 'Microbiology of dental caries', *Journal of Biology and Earth Sciences*, 3(1), pp. M21-M24.

Kassebaum, N., Smith, A., Bernabé, E., Fleming, T., Reynolds, A., Vos, T., Murray, C., Marcenes, W. and Collaborators, G.O.H. (2017) 'Global, regional, and national prevalence, incidence, and disability-adjusted life years for oral conditions for 195 countries, 1990–2015: A systematic analysis for the global burden of diseases, injuries, and risk factors', *Journal of Dental Research*, 96(4), pp. 380-387.

Kaur, R., Gilbert, S.C., Sheehy, E.C. and Beighton, D. (2013) 'Salivary levels of Bifidobacteria in caries-free and caries-active children', *International Journal of Paediatric Dentistry*, 23(1), pp. 32-38.

Keels, M.A., Hale, K.J., Thomas, H.F., Davis, M.J., Czerepak, C.S. and Weiss, P.A. (2008) 'Preventive oral health intervention for pediatricians', *Pediatrics*, 122(6), pp. 1387-1394.

Keijser, B.J.F., Zaura, E., Huse, S.M., van der Vossen, J.M.B.M., Schuren, F.H.J., Montijn, R.C., ten Cate, J.M. and Crielaard, W. (2008) 'Pyrosequencing analysis of the Oral Microflora of healthy adults', *Journal of Dental Research*, 87(11), pp. 1016-1020.

Khvostenko, D., Salehi, S., Naleway, S.E., Hilton, T.J., Ferracane, J.L., Mitchell, J.C. and Kruzic, J.J. (2015) 'Cyclic mechanical loading promotes bacterial penetration along composite restoration marginal gaps', *Dental materials : official publication of the Academy of Dental Materials*, 31(6), pp. 702-710.

Kidd, E. (2011) 'The implications of the new paradigm of dental caries', *Journal of Dentistry*, 39, pp. S3-S8.

Kidd, E. and Fejerskov, O. (2004) 'What constitutes dental caries? Histopathology of carious enamel and dentin related to the action of cariogenic biofilms', *Journal of Dental Research*, 83(1\_suppl), pp. 35-38.

Kielbassa, A.M., Mueller, J. and Gernhardt, C.R. (2009) 'Closing the gap between oral hygiene and minimally invasive dentistry: a review on the resin infiltration technique of incipient (proximal) enamel lesions', *Quintessence International*, 40(8), pp. 663-681.



- Kilian, M., Chapple, I.L.C., Hannig, M., Marsh, P.D., Meuric, V., Pedersen, A.M.L., Tonetti, M.S., Wade, W.G. and Zaura, E. (2016) 'The oral microbiome - an update for oral healthcare professionals', *British Dental Journal*, 221(10), pp. 657-666.
- Kim, J., Park, H.-D. and Chung, S. (2012) 'Microfluidic Approaches to Bacterial Biofilm Formation', *Molecules*, 17(8), p. 9818.
- Kim, Y.-S., Lee, E.-S., Kwon, H.-K. and Kim, B.-I. (2014) 'Monitoring the maturation process of a dental microcosm biofilm using the Quantitative Light-induced Fluorescence-Digital (QLF-D)', *Journal of Dentistry*, 42(6), pp. 691-696.
- Klein, M.I., DeBaz, L., Agidi, S., Lee, H., Xie, G., Lin, A.H.M., Hamaker, B.R., Lemos, J.A. and Koo, H. (2010) 'Dynamics of *Streptococcus mutans* Transcriptome in Response to Starch and Sucrose during Biofilm Development', *PLoS ONE*, 5(10), p. e13478.
- Klein, M.I., Duarte, S., Xiao, J., Mitra, S., Foster, T.H. and Koo, H. (2009) 'Structural and molecular basis of the role of starch and sucrose in *Streptococcus mutans* biofilm development', *Applied and Environmental Microbiology*, 75(3), pp. 837-841.
- Klein, M.I., Hwang, G., Santos, P.H.S., Campanella, O.H. and Koo, H. (2015) 'Streptococcus mutans-derived extracellular matrix in cariogenic oral biofilms', *Frontiers in Cellular and Infection Microbiology*, 5, p. 10.
- Klein, M.I., Scott-Anne, K.M., Gregoire, S., Rosalen, P.L. and Koo, H. (2012) 'Molecular approaches for viable bacterial population and transcriptional analyses in a rodent model of dental caries', *Molecular Oral Microbiology*, 27(5), pp. 350-361.
- Kolenbrander, P.E. (2011) 'Multispecies communities: interspecies interactions influence growth on saliva as sole nutritional source', *International Journal of Oral Science*, 3(2), p. 49.
- Kolenbrander, P.E., Andersen, R.N. and Moore, L.V. (1990) 'Intragenetic coaggregation among strains of human oral bacteria: potential role in primary colonization of the tooth surface', *Applied and Environmental Microbiology*, 56(12), pp. 3890-3894.

- Kolenbrander, P.E., Palmer Jr, R.J., Periasamy, S. and Jakubovics, N.S. (2010) 'Oral multispecies biofilm development and the key role of cell–cell distance', *Nature Reviews Microbiology*, 8(7), pp. 471-480.
- Kolenbrander, P.E., Palmer, R.J., Rickard, A.H., Jakubovics, N.S., Chalmers, N.I. and Diaz, P.I. (2006) 'Bacterial interactions and successions during plaque development', *Periodontology 2000*, 42(1), pp. 47-79.
- Kommerein, N., Stumpp, S.N., Müsken, M., Ehlert, N., Winkel, A., Häussler, S., Behrens, P., Buettner, F.F.R. and Stiesch, M. (2017) 'An oral multispecies biofilm model for high content screening applications', *PLoS ONE*, 12(3), p. e0173973.
- Koo, H., Duarte, S., Murata, R.M., Scott-Anne, K., Gregoire, S., Watson, G.E., Singh, A.P. and Vorsa, N. (2010a) 'Influence of Cranberry Proanthocyanidins on Formation of Biofilms by Streptococcus mutans on Saliva-Coated Apatitic Surface and on Dental Caries Development in vivo', *Caries Research*, 44(2), pp. 116-126.
- Koo, H., Falsetta, M.L. and Klein, M.I. (2013) 'The Exopolysaccharide Matrix: A Virulence Determinant of Cariogenic Biofilm', *Journal of Dental Research*, 92(12), pp. 1065-1073.
- Koo, H., Hayacibara, M.F., Schobel, B.D., Cury, J.A., Rosalen, P.L., Park, Y.K., Vacca-Smith, A.M. and Bowen, W.H. (2003) 'Inhibition of Streptococcus mutans biofilm accumulation and polysaccharide production by apigenin and tt-farnesol', *Journal of Antimicrobial Chemotherapy*, 52(5), pp. 782-789.
- Koo, H., Schobel, B., Scott-Anne, K., Watson, G., Bowen, W.H., Cury, J.A., Rosalen, P.L. and Park, Y.K. (2005) 'Apigenin and tt-farnesol with fluoride effects on S. mutans biofilms and dental caries', *Journal of Dental Research*, 84(11), pp. 1016-1020.
- Koo, H., Xiao, J., Klein, M.I. and Jeon, J.G. (2010b) 'Exopolysaccharides Produced by Streptococcus mutans Glucosyltransferases Modulate the Establishment of Microcolonies within Multispecies Biofilms', *Journal of Bacteriology*, 192(12), pp. 3024-3032.
- Kopec, L.K., Vacca-Smith, A.M. and Bowen, W.H. (1997) 'Structural aspects of glucans formed in solution and on the surface of hydroxyapatite', *Glycobiology*, 7(7), pp. 929-934.

- Kreth, J., Merritt, J. and Qi, F. (2009a) 'Bacterial and Host Interactions of Oral Streptococci', *DNA and Cell Biology*, 28(8), pp. 397-403.
- Kreth, J., Merritt, J., Shi, W. and Qi, F. (2005a) 'Co-ordinated bacteriocin production and competence development: a possible mechanism for taking up DNA from neighbouring species', *Molecular Microbiology*, 57(2), pp. 392-404.
- Kreth, J., Merritt, J., Shi, W. and Qi, F. (2005b) 'Competition and Coexistence between *Streptococcus mutans* and *Streptococcus sanguinis* in the Dental Biofilm', *Journal of Bacteriology*, 187(21), pp. 7193-7203.
- Kreth, J., Vu, H., Zhang, Y. and Herzberg, M.C. (2009b) 'Characterization of hydrogen peroxide-induced DNA release by *Streptococcus sanguinis* and *Streptococcus gordonii*', *Journal of Bacteriology*, 191(20), pp. 6281-6291.
- Kreth, J., Zhang, Y. and Herzberg, M.C. (2008) 'Streptococcal antagonism in oral biofilms: *Streptococcus sanguinis* and *Streptococcus gordonii* interference with *Streptococcus mutans*', *Journal of Bacteriology*, 190(13), pp. 4632-4640.
- Krom, B., Kidwai, S. and Ten Cate, J. (2014) 'Candida and Other Fungal Species Forgotten Players of Healthy Oral Microbiota', *Journal of Dental Research*, 93(5), pp. 445-451.
- Kuhnert, W.L., Zheng, G., Faustoferri, R.C. and Quivey, R.G. (2004) 'The F-ATPase operon promoter of *Streptococcus mutans* is transcriptionally regulated in response to external pH', *Journal of Bacteriology*, 186(24), pp. 8524-8528.
- Kuramitsu, H.K. (1973) 'Characterization of invertase activity from cariogenic *Streptococcus mutans*', *Journal of Bacteriology*, 115(3), pp. 1003-1010.
- Kutsch, V.K. (2014) 'Dental caries: an updated medical model of risk assessment', *The Journal of Prosthetic Dentistry*, 111(4), pp. 280-285.
- Kutsch, V.K. and Cady, C. (2009) 'MIX disease: Diagnosis and treatment', *Inside Dentistry*, 5, pp. 80-83.

Lappann, M., Claus, H., Van Alen, T., Harmsen, M., Elias, J., Molin, S. and Vogel, U. (2010) 'A dual role of extracellular DNA during biofilm formation of *Neisseria meningitidis*', *Molecular Microbiology*, 75(6), pp. 1355-1371.

Lebeaux, D., Chauhan, A., Rendueles, O. and Beloin, C. (2013) 'From in vitro to in vivo Models of Bacterial Biofilm-Related Infections', *Pathogens*, 2(2), p. 288.

Leme, A.F.P., Koo, H., Bellato, C.M., Bedi, G. and Cury, J.A. (2006) 'The role of sucrose in cariogenic dental biofilm formation—new insight', *Journal of Dental Research*, 85(10), pp. 878-887.

Lemme, A., Gröbe, L., Reck, M., Tomasch, J. and Wagner-Döbler, I. (2011) 'Subpopulation-Specific Transcriptome Analysis of Competence-Stimulating-Peptide-Induced *Streptococcus mutans*', *Journal of Bacteriology*, 193(8), pp. 1863-1877.

Lemos, J.A., Abranches, J. and Burne, R.A. (2005) 'Responses of cariogenic streptococci to environmental stresses', *Current Issues in Molecular Biology*, 7(1), pp. 95-108.

Lemos, J.A., Quivey, R.G., Koo, H. and Abranches, J. (2013) 'Streptococcus mutans: a new Gram-positive paradigm?', *Microbiology*, 159(3), pp. 436-445.

Lendenmann, U., Grogan, J. and Oppenheim, F.G. (2000) 'Saliva and Dental Pellicle-A Review', *Advances in Dental Research*, 14(1), pp. 22-28.

Lévesque, C.M., Voronejskaia, E., Huang, Y.-C.C., Mair, R.W., Ellen, R.P. and Cvitkovitch, D.G. (2005) 'Involvement of Sortase Anchoring of Cell Wall Proteins in Biofilm Formation by *Streptococcus mutans*', *Infection and Immunity*, 73(6), pp. 3773-3777.

Li, Y.-H., Lau, P.C.Y., Lee, J.H., Ellen, R.P. and Cvitkovitch, D.G. (2001) 'Natural Genetic Transformation of *Streptococcus mutans* Growing in Biofilms', *Journal of Bacteriology*, 183(3), pp. 897-908.

Li, Y. and Burne, R.A. (2001) 'Regulation of the *gtfBC* and *ftf* genes of *Streptococcus mutans* in biofilms in response to pH and carbohydrate', *Microbiology*, 147(10), pp. 2841-2848.

- Li, Y., Ge, Y., Saxena, D. and Caufield, P.W. (2007) 'Genetic Profiling of the Oral Microbiota Associated with Severe Early-Childhood Caries', *Journal of Clinical Microbiology*, 45(1), pp. 81-87.
- Liao, S., Klein, M.I., Heim, K.P., Fan, Y., Bitoun, J.P., Ahn, S.-J., Burne, R.A., Koo, H., Brady, L.J. and Wen, Z.T. (2014) 'Streptococcus mutans Extracellular DNA Is Upregulated during Growth in Biofilms, Actively Released via Membrane Vesicles, and Influenced by Components of the Protein Secretion Machinery', *Journal of Bacteriology*, 196(13), pp. 2355-2366.
- Lin, C.-H., Chen, Y.-C. and Pan, T.-M. (2011) 'Quantification Bias Caused by Plasmid DNA Conformation in Quantitative Real-Time PCR Assay', *PLoS ONE*, 6(12), p. e29101.
- Ling, Z., Kong, J., Jia, P., Wei, C., Wang, Y., Pan, Z., Huang, W., Li, L., Chen, H. and Xiang, C. (2010) 'Analysis of Oral Microbiota in Children with Dental Caries by PCR-DGGE and Barcoded Pyrosequencing', *Microbial Ecology*, 60(3), pp. 677-690.
- Lingström, P., Van Ruyven, F.O.J., Van Houte, J. and Kent, R. (2000) 'The pH of dental plaque in its relation to early enamel caries and dental plaque flora in humans', *Journal of Dental Research*, 79(2), pp. 770-777.
- Liu, J., Wu, C., Huang, I.-H., Merritt, J. and Qi, F. (2011) 'Differential response of Streptococcus mutans towards friend and foe in mixed-species cultures', *Microbiology*, 157(9), pp. 2433-2444.
- Liu, W., Røder, H.L., Madsen, J.S., Bjarnsholt, T., Sørensen, S.J. and Burmølle, M. (2016) 'Interspecific Bacterial Interactions are Reflected in Multispecies Biofilm Spatial Organization', *Frontiers in Microbiology*, 7, p. 1366.
- Liu, Y. and Burne, R.A. (2011) 'The major autolysin of Streptococcus gordonii is subject to complex regulation and modulates stress tolerance, biofilm formation, and extracellular-DNA release', *Journal of Bacteriology*, 193(11), pp. 2826-2837.

- Loesche, W.J. (1979) 'Clinical and Microbiological Aspects of Chemotherapeutic Agents Used According to the Specific Plaque Hypothesis', *Journal of Dental Research*, 58(12), pp. 2404-2412.
- Loesche, W.J. (1986) 'Role of Streptococcus mutans in human dental decay', *Microbiological Reviews*, 50(4), pp. 353-380.
- Loo, C.Y., Corliss, D.A. and Ganeshkumar, N. (2000) 'Streptococcus gordonii biofilm formation: identification of genes that code for biofilm phenotypes', *Journal of Bacteriology*, 182(5), pp. 1374-1382.
- Lynch, D.J., Fountain, T.L., Mazurkiewicz, J.E. and Banas, J.A. (2007) 'Glucan-binding proteins are essential for shaping Streptococcus mutans biofilm architecture', *FEMS Microbiology Letters*, 268(2), pp. 158-165.
- Lynch, D.J., Michalek, S.M., Zhu, M., Drake, D., Qian, F. and Banas, J.A. (2013) 'Cariogenicity of Streptococcus mutans Glucan-Binding Protein Deletion Mutants', *Oral Health and Dental Management*, 12(4), pp. 191-199.
- Lynch, R.J.M., Navada, R. and Walia, R. (2004) 'Low-levels of fluoride in plaque and saliva and their effects on the demineralisation and remineralisation of enamel; role of fluoride toothpastes', *International Dental Journal*, 54(S5), pp. 304-309.
- Macià, M.D., Rojo-Moliner, E. and Oliver, A. (2014) 'Antimicrobial susceptibility testing in biofilm-growing bacteria', *Clinical Microbiology and Infection*, 20(10), pp. 981-990.
- Maddi, A. and Scannapieco, F.A. (2013) 'Oral biofilms, oral and periodontal infections, and systemic disease', *American Journal of Dentistry*, 26(5), pp. 249-54.
- Mancl, K.A., Kirsner, R.S. and Ajdic, D. (2013) 'Wound biofilms: Lessons learned from oral biofilms', *Wound Repair and Regeneration*, 21(3), pp. 352-362.
- Marchesi, J.R., Sato, T., Weightman, A.J., Martin, T.A., Fry, J.C., Hiom, S.J. and Wade, W.G. (1998) 'Design and Evaluation of Useful Bacterium-Specific PCR Primers That

Amplify Genes Coding for Bacterial 16S rRNA', *Applied and Environmental Microbiology*, 64(2), pp. 795-799.

Marinho, V.C., Worthington, H.V., Walsh, T. and Clarkson, J.E. (2013) 'Fluoride varnishes for preventing dental caries in children and adolescents', *The Cochrane Library*, (7), pp. 1-29.

Marsh, P. (2012) 'Contemporary perspective on plaque control', *British Dental Journal*, 212(12), pp. 601-606.

Marsh, P.D. (2004) 'Dental plaque as a microbial biofilm', *Caries Research*, 38(3), pp. 204-211.

Marsh, P.D. (2006) 'Dental plaque as a biofilm and a microbial community—implications for health and disease', *BMC Oral Health*, 6(Suppl 1), p. S14.

Marsh, P.D. and Devine, D.A. (2011) 'How is the development of dental biofilms influenced by the host?', *Journal of Clinical Periodontology*, 38(s11), pp. 28-35.

Marsh, P.D., Featherstone, A., McKee, A.S., Hallsworth, A.S., Robinson, C., Weatherell, J.A., Newman, H.N. and Pitter, A.F.V. (1989) 'A Microbiological Study of Early Caries of Approximal Surfaces in Schoolchildren', *Journal of Dental Research*, 68(7), pp. 1151-1154.

Marsh, P.D., Head, D.A. and Devine, D.A. (2014) 'Prospects of oral disease control in the future – an opinion', *Journal of Oral Microbiology*, 6, p. 10.3402/jom.v6.26176.

Marsh, P.D., Head, D.A. and Devine, D.A. (2015) 'Ecological approaches to oral biofilms: control without killing', *Caries Research*, 49(Suppl. 1), pp. 46-54.

Marsh, P.D., Moter, A. and Devine, D.A. (2011) 'Dental plaque biofilms: communities, conflict and control', *Periodontology 2000*, 55(1), pp. 16-35.

Martignon, S., Ekstrand, K.R., Gomez, J., Lara, J.S. and Cortes, A. (2012) 'Infiltrating/Sealing Proximal Caries Lesions', *Journal of Dental Research*, 91(3), pp. 288-292.

- Marttinen, A.M., Haukioja, A.L., Keskin, M. and Söderling, E.M. (2013) 'Effects of *Lactobacillus reuteri* PTA 5289 and *L. paracasei* DSMZ16671 on the adhesion and biofilm formation of *Streptococcus mutans*', *Current Microbiology*, 67(2), pp. 193-199.
- Maruyama, F., Kobata, M., Kurokawa, K., Nishida, K., Sakurai, A., Nakano, K., Nomura, R., Kawabata, S., Ooshima, T., Nakai, K., Hattori, M., Hamada, S. and Nakagawa, I. (2009) 'Comparative genomic analyses of *Streptococcus mutans* provide insights into chromosomal shuffling and species-specific content', *BMC Genomics*, 10(1), p. 358.
- Mashburn-Warren, L., Morrison, D.A. and Federle, M.J. (2010) 'A novel double-tryptophan peptide pheromone controls competence in *Streptococcus* spp. via an Rgg regulator', *Molecular Microbiology*, 78(3), pp. 589-606.
- Matsui, R. and Cvitkovitch, D. (2010) 'Acid tolerance mechanisms utilized by *Streptococcus mutans*', *Future Microbiology*, 5(3), pp. 403-417.
- Mattos-Graner, R.O., Klein, M.I. and Smith, D.J. (2014) 'Lessons Learned from Clinical Studies: Roles of Mutans Streptococci in the Pathogenesis of Dental Caries', *Current Oral Health Reports*, 1(1), pp. 70-78.
- McBain, A.J., Bartolo, R.G., Catrenich, C.E., Charbonneau, D., Ledder, R.G., Rickard, A.H., Symmons, S.A. and Gilbert, P. (2003) 'Microbial characterization of biofilms in domestic drains and the establishment of stable biofilm microcosms', *Applied and Environmental Microbiology*, 69(1), pp. 177-185.
- McCabe, R.M. and Donkersloot, J.A. (1977) 'Adherence of *Veillonella* Species Mediated by Extracellular Glucosyltransferase from *Streptococcus salivarius*', *Infection and Immunity*, 18(3), pp. 726-734.
- McSwain, B.S., Irvine, R.L., Hausner, M. and Wilderer, P.A. (2005) 'Composition and Distribution of Extracellular Polymeric Substances in Aerobic Flocs and Granular Sludge', *Applied and Environmental Microbiology*, 71(2), pp. 1051-1057.
- Meagher, R., Liu, P., Light, Y.K., Patel, K., Perroud, T. and Singh, A. (2010) *FISH 'N' CHIPS—A SINGLE CELL GENOMIC ANALYZER FOR THE HUMAN MICROBIOME.*



Sandia National Laboratories (SNL-CA), Livermore, CA (United States), 14th International Conference on Miniaturized Systems for Chemistry and Life Sciences 3 - 7 October 2010, Groningen, The Netherlands, pp. 1640-1642.

Mei, M.L., Chu, C.H., Lo, E.C.M. and Samaranayake, L.P. (2013) 'Preventing root caries development under oral biofilm challenge in an artificial mouth', *Medicina Oral, Patología Oral y Cirugía Bucal. Ed Inglesa*, 18(4), pp. 557-563.

Mercier, C., Durrieu, C., Briandet, R., Domakova, E., Tremblay, J., Buist, G. and Kulakauskas, S. (2002) 'Positive role of peptidoglycan breaks in lactococcal biofilm formation', *Molecular Microbiology*, 46(1), pp. 235-243.

Meurman, J.H. (2005) 'Probiotics: do they have a role in oral medicine and dentistry?', *European Journal of Oral Sciences*, 113(3), pp. 188-196.

Miles, A., Misra, S. and Irwin, J. (1938) 'The estimation of the bactericidal power of the blood', *Journal of Hygiene*, 38(06), pp. 732-749.

Minah, G. and Loesche, W. (1977) 'Sucrose metabolism by prominent members of the flora isolated from cariogenic and non-cariogenic dental plaques', *Infection and Immunity*, 17(1), pp. 55-61.

Mishra, A., Wu, C., Yang, J., Cisar, J.O., Das, A. and Ton-That, H. (2010) 'The Actinomyces oris type 2 fimbrial shaft FimA mediates co-aggregation with oral streptococci, adherence to red blood cells and biofilm development', *Molecular Microbiology*, 77(4), pp. 841-854.

Moyer, V.A. (2014) 'Prevention of Dental Caries in Children From Birth Through Age 5 Years: US Preventive Services Task Force Recommendation Statement', *Pediatrics*, 133(6), p. 1102.

Mulcahy, H., Charron-Mazenod, L. and Lewenza, S. (2008) 'Extracellular DNA Chelates Cations and Induces Antibiotic Resistance in Pseudomonas aeruginosa Biofilms', *PLoS Pathogens*, 4(11), p. e1000213.

Murakami, Y., Nakano, Y., Yamashita, Y. and Koga, T. (1997) 'Identification of a frameshift mutation resulting in premature termination and loss of cell wall anchoring of the PAc antigen of *Streptococcus mutans* GS-5', *Infection and Immunity*, 65(2), pp. 794-797.

Nakano, K., Nemoto, H., Nomura, R., Homma, H., Yoshioka, H., Shudo, Y., Hata, H., Toda, K., Taniguchi, K., Amano, A. and Ooshima, T. (2007) 'Serotype distribution of *Streptococcus mutans* a pathogen of dental caries in cardiovascular specimens from Japanese patients', *Journal of Medical Microbiology*, 56(4), pp. 551-556.

Nance, W.C., Dowd, S.E., Samarian, D., Chludzinski, J., Delli, J., Battista, J. and Rickard, A.H. (2013) 'A high-throughput microfluidic dental plaque biofilm system to visualize and quantify the effect of antimicrobials', *Journal of Antimicrobial Chemotherapy*, 68(11), pp. 2550-2560.

Narisawa, N., Kawarai, T., Suzuki, N., Sato, Y., Ochiai, K., Ohnishi, M., Watanabe, H. and Senpuku, H. (2011) 'Competence-dependent endogenous DNA rearrangement and uptake of extracellular DNA give a natural variant of *Streptococcus mutans* without biofilm formation', *Journal of Bacteriology*, 193(19), pp. 5147-5154.

Nicholls, H. (2005) 'Ancient DNA Comes of Age', *PLoS Biology*, 3(2), p. e56.

Noorda, W.D., Purdell-Lewis, D.J., van Montfort, A.M.A.P. and Weerkamp, A.H. (1988) 'Monobacterial and Mixed Bacterial Plaques of *Streptococcus mutans* and *Veillonella alcalescens* in an Artificial Mouth: Development, Metabolism, and Effect on Human Dental Enamel', *Caries Research*, 22(6), pp. 342-347.

Nyvad, B., Crielaard, W., Mira, A., Takahashi, N. and Beighton, D. (2013) 'Dental Caries from a Molecular Microbiological Perspective', *Caries Research*, 47(2), pp. 89-102.

Okada, M., Kawamura, M., Oda, Y., Yasuda, R.I.E., Kojima, T. and Kurihara, H. (2012) 'Caries prevalence associated with *Streptococcus mutans* and *Streptococcus sobrinus* in Japanese schoolchildren', *International Journal of Paediatric Dentistry*, 22(5), pp. 342-348.

Okshevsky, M. and Meyer, R.L. (2015) 'The role of extracellular DNA in the establishment, maintenance and perpetuation of bacterial biofilms', *Critical Reviews in Microbiology*, 41(3), pp. 341-352.

Oldham, A.L. and Duncan, K.E. (2012) 'Similar Gene Estimates from Circular and Linear Standards in Quantitative PCR Analyses Using the Prokaryotic 16S rRNA Gene as a Model', *PLoS ONE*, 7(12), p. e51931.

Oli, M.W., Otoo, H.N., Crowley, P.J., Heim, K.P., Nascimento, M.M., Ramsook, C.B., Lipke, P.N. and Brady, L.J. (2012) 'Functional amyloid formation by *Streptococcus mutans*', *Microbiology*, 158(12), pp. 2903-2916.

Pahel, B.T., Rozier, R.G., Stearns, S.C. and Quiñonez, R.B. (2011) 'Effectiveness of Preventive Dental Treatments by Physicians for Young Medicaid Enrollees', *Pediatrics*, 127(3), pp. e682-e689.

Palmer, J., Robert J., Gordon, S.M., Cisar, J.O. and Kolenbrander, P.E. (2003) 'Coaggregation-Mediated Interactions of Streptococci and Actinomyces Detected in Initial Human Dental Plaque', *Journal of Bacteriology*, 185(11), pp. 3400-3409.

Palmer, L.J., Chapple, I.L.C., Wright, H.J., Roberts, A. and Cooper, P.R. (2012) 'Extracellular deoxyribonuclease production by periodontal bacteria', *Journal of Periodontal Research*, 47(4), pp. 439-445.

Palmer, R.J., Diaz, P.I. and Kolenbrander, P.E. (2006) 'Rapid succession within the Veillonella population of a developing human oral biofilm in situ', *Journal of Bacteriology*, 188(11), pp. 4117-4124.

Palmer, R.J., Kazmerzak, K., Hansen, M.C. and Kolenbrander, P.E. (2001) 'Mutualism versus Independence: Strategies of Mixed-Species Oral Biofilms In Vitro Using Saliva as the Sole Nutrient Source', *Infection and Immunity*, 69(9), pp. 5794-5804.

Palmer, S.R., Miller, J.H., Abranches, J., Zeng, L., Lefebure, T., Richards, V.P., Lemos, J.A., Stanhope, M.J. and Burne, R.A. (2013) 'Phenotypic Heterogeneity of Genomically-Diverse Isolates of *Streptococcus mutans*', *PLoS ONE*, 8(4), p. e61358.

Pamp, S.J., Sternberg, C. and Tolker-Nielsen, T. (2009) 'Insight into the microbial multicellular lifestyle via flow-cell technology and confocal microscopy', *Cytometry Part A*, 75A(2), pp. 90-103.

Panariello, B.H.D., de Araújo Costa, C.A.G., Pavarina, A.C., Santiago, S.L. and Duarte, S. (2017) 'Advances and Challenges in Oral Biofilm Control', *Current Oral Health Reports*, 4(1), pp. 29-33.

Paris, S., Hopfenmuller, W. and Meyer-Lueckel, H. (2010) 'Resin infiltration of caries lesions: an efficacy randomized trial', *Journal of Dental Research*, 89(8), pp. 823-826.

Paris, S., Meyer-Lueckel, H. and Kielbassa, A.M. (2007) 'Resin Infiltration of Natural Caries Lesions', *Journal of Dental Research*, 86(7), pp. 662-666.

Paster, B.J., Bartoszyk, I.M. and Dewhirst, F.E. (1998) 'Identification of oral streptococci using PCR-based, reverse-capture, checkerboard hybridization', *Methods in Cell Science*, 20(1), pp. 223-231.

Paster, B.J., Olsen, I., Aas, J.A. and Dewhirst, F.E. (2006) 'The breadth of bacterial diversity in the human periodontal pocket and other oral sites', *Periodontology 2000*, 42(1), pp. 80-87.

Percival, S.L., Malic, S., Cruz, H. and Williams, D.W. (2011) 'Introduction to Biofilms', in Percival, S., Knottenbelt, D. and Cochrane, C. (eds.) *Biofilms and Veterinary Medicine*. Berlin, Heidelberg: Springer Berlin Heidelberg, pp. 41-68.

Periasamy, S., Chalmers, N.I., Du-Thumm, L. and Kolenbrander, P.E. (2009) 'Fusobacterium nucleatum ATCC 10953 Requires Actinomyces naeslundii ATCC 43146 for Growth on Saliva in a Three-Species Community That Includes Streptococcus oralis 34', *Applied and Environmental Microbiology*, 75(10), pp. 3250-3257.

Periasamy, S. and Kolenbrander, P.E. (2009a) 'Aggregatibacter actinomycetemcomitans Builds Mutualistic Biofilm Communities with Fusobacterium nucleatum and Veillonella Species in Saliva', *Infection and Immunity*, 77(9), pp. 3542-3551.

Periasamy, S. and Kolenbrander, P.E. (2009b) 'Mutualistic Biofilm Communities Develop with Porphyromonas gingivalis and Initial, Early, and Late Colonizers of Enamel', *Journal of Bacteriology*, 191(22), pp. 6804-6811.

Periasamy, S. and Kolenbrander, P.E. (2010) 'Central Role of the Early Colonizer Veillonella sp. in Establishing Multispecies Biofilm Communities with Initial, Middle, and Late Colonizers of Enamel', *Journal of Bacteriology*, 192(12), pp. 2965-2972.

Perry, J.A., Cvitkovitch, D.G. and Lévesque, C.M. (2009) 'Cell death in Streptococcus mutans biofilms: a link between CSP and extracellular DNA', *FEMS Microbiology Letters*, 299(2), pp. 261-266.

Peters, B.M., Jabra-Rizk, M.A., Graeme, A., Costerton, J.W. and Shirtliff, M.E. (2012) 'Polymicrobial interactions: impact on pathogenesis and human disease', *Clinical Microbiology Reviews*, 25(1), pp. 193-213.

Petersen, F.C., Tao, L. and Scheie, A.A. (2005) 'DNA binding-uptake system: a link between cell-to-cell communication and biofilm formation', *Journal of Bacteriology*, 187(13), pp. 4392-4400.

Petersen, P.E. and Lennon, M.A. (2004) 'Effective use of fluorides for the prevention of dental caries in the 21st century: the WHO approach', *Community Dentistry and Oral Epidemiology*, 32(5), pp. 319-321.

Peterson, S.N., Snesrud, E., Liu, J., Ong, A.C., Kilian, M., Schork, N.J. and Bretz, W. (2013) 'The Dental Plaque Microbiome in Health and Disease', *PLoS ONE*, 8(3), p. e58487.

Pitts, N. (2004) 'Are we ready to move from operative to non-operative/preventive treatment of dental caries in clinical practice?', *Caries Research*, 38(3), pp. 294-304.

Powell, L.V. (1998) 'Caries prediction: a review of the literature', *Community Dentistry and Oral Epidemiology*, 26(6), pp. 361-371.

- Prada-López, I., Quintas, V., Vilaboa, C., Suárez-Quintanilla, D. and Tomás, I. (2016) 'Devices for In situ Development of Non-disturbed Oral Biofilm. A Systematic Review', *Frontiers in Microbiology*, 7, p. 1055.
- Pratten, J., Smith, A. and Wilson, M. (1998) 'Response of single species biofilms and microcosm dental plaques to pulsing with chlorhexidine', *Journal of Antimicrobial Chemotherapy*, 42, pp. 453-459.
- Pretty, I.A., Edgar, W.M., Smith, P.W. and Higham, S.M. (2005) 'Quantification of dental plaque in the research environment', *Journal of Dentistry*, 33(3), pp. 193-207.
- Preza, D., Olsen, I., Aas, J.A., Willumsen, T., Grinde, B. and Paster, B.J. (2008) 'Bacterial profiles of root caries in elderly patients', *Journal of Clinical Microbiology*, 46(6), pp. 2015-2021.
- Qin, Z., Ou, Y., Yang, L., Zhu, Y., Tolker-Nielsen, T., Molin, S. and Qu, D. (2007) 'Role of autolysin-mediated DNA release in biofilm formation of *Staphylococcus epidermidis*', *Microbiology*, 153(7), pp. 2083-2092.
- Quintas, V., Prada-López, I., Prados-Frutos, J.C. and Tomás, I. (2015) 'In situ antimicrobial activity on oral biofilm: essential oils vs. 0.2% chlorhexidine', *Clinical Oral Investigations*, 19(1), pp. 97-107.
- Reddy, S., Kaul, S., Prasad, M.G.S., Asutkar, H. and Bhowmik, N. (2012) 'Dental Plaque “Unveiling the Biofilm Inside”', *E-Journal of Dentistry*, 2(1), pp. 119-125.
- Rice, K.C. and Bayles, K.W. (2003) 'Death's toolbox: examining the molecular components of bacterial programmed cell death', *Molecular Microbiology*, 50(3), pp. 729-738.
- Rice, K.C. and Bayles, K.W. (2008) 'Molecular control of bacterial death and lysis', *Microbiology and Molecular Biology Reviews*, 72(1), pp. 85-109.
- Richards, V.P., Alvarez, A.J., Luce, A.R., Bedenbaugh, M., Mitchell, M.L., Burne, R.A. and Nascimento, M.M. (2017) 'Microbiomes of Site-Specific Dental Plaques from Children with Different Caries Status', *Infection and Immunity*, 85(8), pp. 1-11.

Rickard, A.H., Gilbert, P., High, N.J., Kolenbrander, P.E. and Handley, P.S. (2003) 'Bacterial coaggregation: an integral process in the development of multi-species biofilms', *Trends in Microbiology*, 11(2), pp. 94-100.

Ricker, A., Vickerman, M. and Dongari-Bagtzoglou, A. (2014) 'Streptococcus gordonii glucosyltransferase promotes biofilm interactions with Candida albicans', *Journal of Oral Microbiology*, 6, pp. 1-11.

Riley, P., Moore, D., Ahmed, F., Sharif, M.O. and Worthington, H.V. (2015) 'Xylitol-containing products for preventing dental caries in children and adults', *Cochrane Database of Systematic Reviews*, (3), pp. 1-24.

Rocco, C.J., Davey, M.E., Bakaletz, L.O. and Goodman, S.D. (2017) 'Natural antigenic differences in the functionally equivalent extracellular DNABII proteins of bacterial biofilms provide a means for targeted biofilm therapeutics', *Molecular Oral Microbiology*, 32(2), pp. 118-130.

Rosier, B.T., De Jager, M., Zaura, E. and Krom, B.P. (2014) 'Historical and contemporary hypotheses on the development of oral diseases: are we there yet?', *Frontiers in Cellular and Infection Microbiology*, 4(92), pp. 1-11.

Rostami, N., Shields, R.C., Yassin, S.A., Hawkins, A.R., Bowen, L., Luo, T.L., Rickard, A.H., Holliday, R., Preshaw, P.M. and Jakubovics, N.S. (2017) 'A Critical Role for Extracellular DNA in Dental Plaque Formation', *Journal of Dental Research*, 96(2), pp. 208-216.

Rozen, R., Bachrach, G., Bronshteyn, M., Gedalia, I. and Steinberg, D. (2001) 'The role of fructans on dental biofilm formation by Streptococcus sobrinus, Streptococcus mutans, Streptococcus gordonii and Actinomyces viscosus', *FEMS Microbiology Letters*, 195(2), pp. 205-210.

Russell, C. and Coulter, W.A. (1975) 'Continuous monitoring of pH and Eh in bacterial plaque grown on a tooth in an artificial mouth', *Applied Microbiology*, 29(2), pp. 141-144.

Salli, K.M. and Ouwehand, A.C. (2015) 'The use of in vitro model systems to study dental biofilms associated with caries: a short review', *Journal of Oral Microbiology*, 7, p. 10.3402/jom.v7.26149.

Sampaio-Maia, B. and Monteiro-Silva, F. (2014) 'Acquisition and maturation of oral microbiome throughout childhood: An update', *Dental Research Journal (Isfahan)*, 11(3), pp. 291-301.

Sánchez-Pérez, L., Irigoyen, M. and Zepeda, M. (2010) 'Dental caries, tooth eruption timing and obesity: a longitudinal study in a group of Mexican schoolchildren', *Acta Odontologica Scandinavica*, 68(1), pp. 57-64.

Sansone, C., Van Houte, J., Joshipura, K., Kent, R. and Margolis, H.C. (1993) 'The association of mutans streptococci and non-mutans streptococci capable of acidogenesis at a low pH with dental caries on enamel and root surfaces', *Journal of Dental Research*, 72(2), pp. 508-516.

Santos, A. (2003) 'Evidence-based control of plaque and gingivitis', *Journal of Clinical Periodontology*, 30(s5), pp. 13-16.

Sato, Y., Okamoto, K. and Kizaki, H. (2002) 'gbpC and pac gene mutations detected in *Streptococcus mutans* strain GS-5', *Oral Microbiology and Immunology*, 17(4), pp. 263-266.

Sato, Y., Yamamoto, Y. and Kizaki, H. (1997) 'Cloning and sequence analysis of the gbpC gene encoding a novel glucan-binding protein of *Streptococcus mutans*', *Infection and Immunity*, 65(2), pp. 668-675.

Scannapieco, F.A. (1994) 'Saliva-Bacterium Interactions in Oral Microbial Ecology', *Critical Reviews in Oral Biology & Medicine*, 5(3), pp. 203-248.

Scannapieco, F.A. (2013) 'The oral microbiome: Its role in health and in oral and systemic infections', *Clinical Microbiology Newsletter*, 35(20), pp. 163-169.

Schooling, S.R. and Beveridge, T.J. (2006) 'Membrane Vesicles: an Overlooked Component of the Matrices of Biofilms', *Journal of Bacteriology*, 188(16), pp. 5945-5957.



Selwitz, R.H., Ismail, A.I. and Pitts, N.B. (2007) 'Dental caries', *The Lancet*, 369(9555), pp. 51-59.

Senadheera, D.B., Cordova, M., Ayala, E.A., de Paz, L.C., Singh, K., Downey, J.S., Svensäter, G., Goodman, S.D. and Cvitkovitch, D. (2012) 'Regulation of bacteriocin production and cell death by the VicRK signaling system in *Streptococcus mutans*', *Journal of Bacteriology*, 194(6), pp. 1307-1316.

Sharawy, A. and Socransky, S. (1967) 'Effect of human streptococcus strain GS-5 on caries and alveolar bone loss in conventional mice and rats', *Journal of Dental Research*, 46(6), pp. 1385-1391.

Sherry, L., Lappin, G., O'Donnell, L.E., Millhouse, E., Millington, O.R., Bradshaw, D.J., Axe, A.S., Williams, C., Nile, C.J. and Ramage, G. (2016) 'Viable Compositional Analysis of an Eleven Species Oral Polymicrobial Biofilm', *Frontiers in Microbiology*, 7, p. 912.

Shields, R.C. (2014) 'Extracellular DNA in head and neck biofilms, Ph.D thesis, Newcastle University, Newcastle Upon Tyne'.

Shu, M., Wong, L., Miller, J.H. and Sissons, C.H. (2000) 'Development of multi-species consortia biofilms of oral bacteria as an enamel and root caries model system', *Archives of Oral Biology*, 45(1), pp. 27-40.

Shumi, W., Lim, J., Nam, S.-W., Lee, K., Kim, S.H., Kim, M.-H., Cho, K.-S. and Park, S. (2010) 'Environmental factors that affect *Streptococcus mutans* biofilm formation in a microfluidic device mimicking teeth', *BioChip Journal*, 4(4), pp. 257-263.

Sissons, C.H. (1997) 'Artificial Dental Plaque Biofilm Model Systems', *Advances in Dental Research*, 11(1), pp. 110-126.

Smith, T.J., Blackman, S.A. and Foster, S.J. (2000) 'Autolysins of *Bacillus subtilis*: multiple enzymes with multiple functions', *Microbiology*, 146(2), pp. 249-262.

Socransky, S.S. and Haffajee, A.D. (2002) 'Dental biofilms: difficult therapeutic targets', *Periodontology 2000*, 28(1), pp. 12-55.

Song, L., Wang, W., Conrads, G., Rheinberg, A., Sztajer, H., Reck, M., Wagner-Döbler, I. and Zeng, A.-P. (2013) 'Genetic variability of mutans streptococci revealed by wide whole-genome sequencing', *BMC Genomics*, 14(1), p. 430.

Soro, V., Dutton, L.C., Sprague, S.V., Nobbs, A.H., Ireland, A.J., Sandy, J.R., Jepson, M.A., Micaroni, M., Splatt, P.R. and Dymock, D. (2014) 'Axenic culture of a candidate division TM7 bacterium from the human oral cavity and biofilm interactions with other oral bacteria', *Applied and Environmental Microbiology*, 80(20), pp. 6480-6489.

Spatafora, G., Rohrer, K., Barnard, D. and Michalek, S. (1995) 'A *Streptococcus mutans* mutant that synthesizes elevated levels of intracellular polysaccharide is hypercariogenic in vivo', *Infection and Immunity*, 63(7), pp. 2556-2563.

Steiner-Oliveira, C., Maciel, F.A., Rodrigues, L.K.A., Napimoga, M.H., Pimenta, L.A.F., Höfling, J.F. and Gonçalves, R.B. (2007) 'An in vitro microbial model for producing caries-like lesions on enamel', *Brazilian Journal of Oral Sciences*, 6(22), pp. 1392-1396.

Strużycka, I. (2014) 'The oral microbiome in dental caries', *Polish Journal of Microbiology*, 63(2), pp. 127-135.

Sturgeon, A., Stull, J.W., Costa, M.C. and Weese, J.S. (2013) 'Metagenomic analysis of the canine oral cavity as revealed by high-throughput pyrosequencing of the 16S rRNA gene', *Veterinary Microbiology*, 162(2), pp. 891-898.

Sullan, R.M.A., Li, J.K., Crowley, P.J., Brady, L.J. and Dufrêne, Y.F. (2015) 'Binding Forces of *Streptococcus mutans* P1 Adhesin', *ACS nano*, 9(2), pp. 1448-1460.

Suzuki, N., Yoshida, A. and Nakano, Y. (2005) 'Quantitative analysis of multi-species oral biofilms by TaqMan real-time PCR', *Clinical Medicine & Research*, 3(3), pp. 176-185.

Takahashi, N. and Nyvad, B. (2008) 'Caries Ecology Revisited: Microbial Dynamics and the Caries Process', *Caries Research*, 42(6), pp. 409-418.

Takahashi, N. and Nyvad, B. (2011) 'The Role of Bacteria in the Caries Process: Ecological Perspectives', *Journal of Dental Research*, 90(3), pp. 294-303.

- Tang, G., Yip, H.-K., Cutress, T.W. and Samaranayake, L.P. (2003) 'Artificial mouth model systems and their contribution to caries research: a review', *Journal of Dentistry*, 31(3), pp. 161-171.
- Tang, L., Schramm, A., Neu, T.R., Revsbech, N.P. and Meyer, R.L. (2013) 'Extracellular DNA in adhesion and biofilm formation of four environmental isolates: a quantitative study', *FEMS Microbiology Ecology*, 86(3), pp. 394-403.
- Tanner, A.C.R. (2015) 'Anaerobic culture to detect periodontal and caries pathogens', *Journal of Oral Biosciences*, 57(1), pp. 18-26.
- Tanner, A.C.R., Kent, R.L., Holgerson, P.L., Hughes, C.V., Loo, C.Y., Kanasi, E., Chalmers, N.I. and Johansson, I. (2011a) 'Microbiota of severe early childhood caries before and after therapy', *Journal of Dental Research*, 90(11), pp. 1298-1305.
- Tanner, A.C.R., Mathney, J.M.J., Kent, R.L., Chalmers, N.I., Hughes, C.V., Loo, C.Y., Pradhan, N., Kanasi, E., Hwang, J., Dahlan, M.A., Papadopolou, E. and Dewhirst, F.E. (2011b) 'Cultivable Anaerobic Microbiota of Severe Early Childhood Caries', *Journal of Clinical Microbiology*, 49(4), pp. 1464-1474.
- Tanzer, J.M. (1979) 'Essential dependence of smooth surface caries on, and augmentation of fissure caries by, sucrose and *Streptococcus mutans* infection', *Infection and Immunity*, 25(2), pp. 526-531.
- Tanzer, J.M., Freedman, M.L., Woodiel, F.N., Eifert, R.L. and Rinehimer, L.A. (1976) *Journal of Dental Research*, 55, pp. B173-B173
- Tanzer, J.M., Livingston, J. and Thompson, A.M. (2001) 'The microbiology of primary dental caries in humans', *Journal of Dental Education*, 65(10), pp. 1028-1037.
- ten Cate, J.M. (2006) 'Biofilms, a new approach to the microbiology of dental plaque', *Odontology*, 94(1), pp. 1-9.

- Teng, F., Yang, F., Huang, S., Bo, C., Xu, Zhenjiang Z., Amir, A., Knight, R., Ling, J. and Xu, J. (2015) 'Prediction of Early Childhood Caries via Spatial-Temporal Variations of Oral Microbiota', *Cell Host & Microbe*, 18(3), pp. 296-306.
- Thomas, V.C., Hiromasa, Y., Harms, N., Thurlow, L., Tomich, J. and Hancock, L.E. (2009) 'A fratricidal mechanism is responsible for eDNA release and contributes to biofilm development of *Enterococcus faecalis*', *Molecular Microbiology*, 72(4), pp. 1022-1036.
- Thomas, V.C., Thurlow, L.R., Boyle, D. and Hancock, L.E. (2008) 'Regulation of autolysis-dependent extracellular DNA release by *Enterococcus faecalis* extracellular proteases influences biofilm development', *Journal of Bacteriology*, 190(16), pp. 5690-5698.
- Thurnheer, T., Gmür, R. and Guggenheim, B. (2004) 'Multiplex FISH analysis of a six-species bacterial biofilm', *Journal of Microbiological Methods*, 56(1), pp. 37-47.
- Usha, C. and Sathyanarayanan, R. (2009) 'Dental caries-A complete changeover (Part I)', *Journal of Conservative Dentistry: JCD*, 12(2), p. 46.
- Van Houte, J., Sansone, C., Joshipura, K. and Kent, R. (1991) 'Mutans streptococci and non-mutans streptococci acidogenic at low pH, and in vitro acidogenic potential of dental plaque in two different areas of the human dentition', *Journal of Dental Research*, 70(12), pp. 1503-1507.
- van Loveren, C. and Duggal, M.S. (2001) 'The role of diet in caries prevention', *International Dental Journal*, 51(S6), pp. 399-406.
- Venkataramaiah, P.D. and Biradar, B. (2011) 'Plaque biofilm', in *Gingival Diseases-Their Aetiology, Prevention and Treatment*. INTECH, pp. 23-40.
- Vilain, S., Pretorius, J.M., Theron, J. and Brözel, V.S. (2009) 'DNA as an adhesin: *Bacillus cereus* requires extracellular DNA to form biofilms', *Applied and Environmental Microbiology*, 75(9), pp. 2861-2868.
- Vlassov, V.V., Laktionov, P.P. and Rykova, E.Y. (2007) 'Extracellular nucleic acids', *BioEssays*, 29(7), pp. 654-667.

Wade, W.G. (2013) 'The oral microbiome in health and disease', *Pharmacological Research*, 69(1), pp. 137-143.

Walsh, T., Glenny, A.-M., Worthington, H.V., Marinho, V.C.C. and Appelbe, P. (2009) 'Fluoride toothpastes of different concentrations for preventing dental caries in children and adolescents', *Cochrane Database of Systematic Reviews*, (3), pp. 1-9.

Wan, A.K.L., Seow, W.K., Purdie, D.M., Bird, P.S., Walsh, L.J. and Tudehope, D.I. (2003) 'A Longitudinal Study of Streptococcus mutans Colonization in Infants after Tooth Eruption', *Journal of Dental Research*, 82(7), pp. 504-508.

Washio, J., Shimada, Y., Yamada, M., Sakamaki, R. and Takahashi, N. (2014) 'Effects of pH and Lactate on Hydrogen Sulfide Production by Oral Veillonella spp', *Applied and Environmental Microbiology*, 80(14), pp. 4184-4188.

Watnick, P. and Kolter, R. (2000) 'Biofilm, city of microbes', *Journal of Bacteriology*, 182(10), pp. 2675-2679.

Welch, M., Jessica L., Rossetti, B.J., Rieken, C.W., Dewhirst, F.E. and Borisy, G.G. (2016) 'Biogeography of a human oral microbiome at the micron scale', *Proceedings of the National Academy of Sciences*, 113(6), pp. E791-E800.

Wenderska, I.B., Lukenda, N., Cordova, M., Magarvey, N., Cvitkovitch, D.G. and Senadheera, D.B. (2012) 'A novel function for the competence inducing peptide, XIP, as a cell death effector of Streptococcus mutans', *FEMS Microbiology Letters*, 336(2), pp. 104-112.

Weyant, R.J., Tracy, S.L., Anselmo, T., Beltrán-Aguilar, E.D., Donly, K.J., Frese, W.A., Hujoel, P.P., Iafolla, T., Kohn, W., Kumar, J., Levy, S.M., Tinanoff, N., Wright, J.T., Zero, D., Aravamudhan, K., Frantsve-Hawley, J. and Meyer, D.M. (2013) 'Topical fluoride for caries prevention', *The Journal of the American Dental Association*, 144(11), pp. 1279-1291.

Whitchurch, C.B., Tolker-Nielsen, T., Ragas, P.C. and Mattick, J.S. (2002) 'Extracellular DNA Required for Bacterial Biofilm Formation', *Science*, 295(5559), p. 1487.

Whitmore, S.E. and Lamont, R.J. (2011) 'The pathogenic persona of community-associated oral streptococci', *Molecular Microbiology*, 81(2), pp. 305-314.

Wolff, M.S. and Larson, C. (2009) 'The cariogenic dental biofilm: good, bad or just something to control?', *Brazilian Oral Research*, 23, pp. 31-38.

Wood, S.R., Kirkham, J., Marsh, P.D., Shore, R.C., Nattress, B. and Robinson, C. (2000) 'Architecture of intact natural human plaque biofilms studied by confocal laser scanning microscopy', *Journal of Dental Research*, 79(1), pp. 21-27.

Wright, C.J., Burns, L.H., Jack, A.A., Back, C.R., Dutton, L.C., Nobbs, A.H., Lamont, R.J. and Jenkinson, H.F. (2013) 'Microbial interactions in building of communities', *Molecular Oral Microbiology*, 28(2), pp. 83-101.

Xiao, J., Klein, M.I., Falsetta, M.L., Lu, B., Delahunty, C.M., Yates III, J.R., Heydorn, A. and Koo, H. (2012) 'The Exopolysaccharide Matrix Modulates the Interaction between 3D Architecture and Virulence of a Mixed-Species Oral Biofilm', *PLoS Pathogens*, 8(4), p. e1002623.

Xiao, J. and Koo, H. (2010) 'Structural organization and dynamics of exopolysaccharide matrix and microcolonies formation by *Streptococcus mutans* in biofilms', *Journal of Applied Microbiology*, 108(6), pp. 2103-2113.

Xu, X., He, J., Xue, J., Wang, Y., Li, K., Zhang, K., Guo, Q., Liu, X., Zhou, Y., Cheng, L., Li, M., Li, Y., Li, Y., Shi, W. and Zhou, X. (2015) 'Oral cavity contains distinct niches with dynamic microbial communities', *Environmental Microbiology*, 17(3), pp. 699-710.

Xu, X., Zhou, X.D. and Wu, C.D. (2011) 'The Tea Catechin Epigallocatechin Gallate Suppresses Cariogenic Virulence Factors of *Streptococcus mutans*', *Antimicrobial Agents and Chemotherapy*, 55(3), pp. 1229-1236.

Yamane, K., Nambu, T., Yamanaka, T., Ishihara, K., Tatami, T., Mashimo, C., Walker, C.B., Leung, K.P. and Fukushima, H. (2013) 'Pathogenicity of exopolysaccharide-producing *Actinomyces oris* isolated from an apical abscess lesion', *International Endodontic Journal*, 46(2), pp. 145-154.

- Yamashita, Y., Bowen, W.H., Burne, R.A. and Kuramitsu, H.K. (1993) 'Role of the *Streptococcus mutans* gtf genes in caries induction in the specific-pathogen-free rat model', *Infection and Immunity*, 61(9), pp. 3811-3817.
- Yang, L., Liu, Y., Wu, H., Høiby, N., Molin, S. and Song, Z.-j. (2011) 'Current understanding of multi-species biofilms', *International Journal of Oral Science*, 3(2), pp. 74-81.
- Yassin, S.A. (2015) 'A fluoride releasing dental prosthesis copolymer for oral biofilm control, Ph.D thesis, Newcastle University, Newcastle Upon Tyne'.
- Yassin, S.A., German, M.J., Rolland, S.L., Rickard, A.H. and Jakubovics, N.S. (2016) 'Inhibition of multispecies biofilms by a fluoride-releasing dental prosthesis copolymer', *Journal of Dentistry*, 48, pp. 62-70.
- Yasunaga, A., Yoshida, A., Morikawa, K., Maki, K., Nakamura, S., Soh, I., Awano, S. and Ansai, T. (2013) 'Monitoring the prevalence of viable and dead cariogenic bacteria in oral specimens and in vitro biofilms by qPCR combined with propidium monoazide', *BMC Microbiology*, 13(1), p. 157.
- Yengopal, V., Mickenautsch, S., Bhayat, A., Chikte, U.M.E. and Oliveira, L.B. (2010) 'Salt fluoridation : a meta-analysis of its efficacy for caries prevention : scientific', *South African Dental Journal*, 65(2), pp. 60-67.
- Yeung, C.A., Hitchings, J.L., Macfarlane, T.V., Threlfall, A.G., Tickle, M., Glenny, A.M. and Ao, E.C.R. (2005) 'Fluoridated milk for preventing dental caries', *Australian Dental Journal*, 50(4), pp. 286-287.
- Yeung, M.K. (1999) 'Molecular and Genetic Analyses of *Actinomyces* SPP', *Critical Reviews in Oral Biology & Medicine*, 10(2), pp. 120-138.
- Yoshida, A., Suzuki, N., Nakano, Y., Kawada, M., Oho, T. and Koga, T. (2003) 'Development of a 5' Nuclease-Based Real-Time PCR Assay for Quantitative Detection of Cariogenic Dental Pathogens *Streptococcus mutans* and *Streptococcus sobrinus*', *Journal of Clinical Microbiology*, 41(9), pp. 4438-4441.

Yoshida, Y., Ganguly, S., Bush, C.A. and Cisar, J.O. (2005) 'Carbohydrate engineering of the recognition motifs in streptococcal co-aggregation receptor polysaccharides', *Molecular Microbiology*, 58(1), pp. 244-256.

Zaura, E., Buijs, M.J., Hoogenkamp, M.A., Ciric, L., Papetti, A., Signoretto, C., Stauder, M., Lingström, P., Pratten, J. and Spratt, D.A. (2011) 'The effects of fractions from shiitake mushroom on composition and cariogenicity of dental plaque microcosms in an in vitro caries model', *BioMed Research International*, 2011, pp. 1-10.

Zaura, E., Keijser, B.J.F., Huse, S.M. and Crielaard, W. (2009) 'Defining the healthy" core microbiome" of oral microbial communities', *BMC Microbiology*, 9(1), p. 259.

Zeng, L., Martino, N.C. and Burne, R.A. (2012) 'Two Gene Clusters Coordinate Galactose and Lactose Metabolism in *Streptococcus gordonii*', *Applied and Environmental Microbiology*, 78(16), pp. 5597-5605.

Zero, D.T., Fontana, M., Martínez-Mier, E.A., Ferreira-Zandoná, A., Ando, M., González-Cabezas, C. and Bayne, S. (2009) 'The biology, prevention, diagnosis and treatment of dental caries Scientific advances in the United States', *The Journal of the American Dental Association*, 140(suppl 1), pp. 25S-34S.

Zhang, L. and Mah, T.-F. (2008) 'Involvement of a novel efflux system in biofilm-specific resistance to antibiotics', *Journal of Bacteriology*, 190(13), pp. 4447-4452.

Zheng, C., Hoque, A.T.M.S., Braddon, V.R., Baum, B.J. and O'Connell, B.C. (2001) 'Evaluation of salivary gland acinar and ductal cell-specific promoters in vivo with recombinant adenoviral vectors', *Human Gene Therapy*, 12(18), pp. 2215-2223.

Zheng, L., Chen, Z., Itzek, A., Herzberg, M.C. and Kreth, J. (2012) 'CcpA Regulates Biofilm Formation and Competence in *Streptococcus gordonii*', *Molecular Oral Microbiology*, 27(2), pp. 83-94.

Zheng, L., Itzek, A., Chen, Z. and Kreth, J. (2011) 'Environmental Influences on Competitive Hydrogen Peroxide Production in *Streptococcus gordonii*', *Applied and Environmental Microbiology*, 77(13), pp. 4318-4328.



- Zhou, L., Srisatjaluk, R., Justus, D.E. and Doyle, R.J. (1998) 'On the origin of membrane vesicles in Gram-negative bacteria', *FEMS Microbiology Letters*, 163(2), pp. 223-228.
- Zhou, P., Liu, J., Li, X., Takahashi, Y. and Qi, F. (2015) 'The Sialic Acid Binding Protein, Hsa, in *Streptococcus gordonii* DL1 also Mediates Intergeneric Coaggregation with *Veillonella* Species', *PLoS ONE*, 10(11), p. e0143898.
- Zhou, Y., Yang, J., Zhang, L., Zhou, X., Cisar, J.O. and Palmer, R.J. (2016) 'Differential utilization of basic proline-rich glycoproteins during growth of oral bacteria in saliva', *Applied and Environmental Microbiology*, 82(17), pp. 5249-5258.
- Zhu, L. and Kreth, J. (2012) 'The role of hydrogen peroxide in environmental adaptation of oral microbial communities', *Oxidative Medicine and Cellular Longevity*, 2012, pp. 1-10.
- Zijnge, V., Ammann, T., Thurnheer, T. and Gmuer, R. (2011) 'Subgingival biofilm structure', in *Periodontal Disease*. Karger Publishers, pp. 1-16.
- Zijnge, V., van Leeuwen, M.B.M., Degener, J.E., Abbas, F., Thurnheer, T., Gmür, R. and M. Harmsen, H.J. (2010) 'Oral Biofilm Architecture on Natural Teeth', *PLoS ONE*, 5(2), p. e9321.